



केन्द्रीय विद्यालय संगठन
Kendriya Vidyalaya Sangathan

कम्प्यूटर विज्ञान
COMPUTER SCIENCE (083)

कक्षा/Class: XI
2024-25

विद्यार्थी अध्ययन सामग्री
Student Support Material



संदेश

विद्यालयी शिक्षा में शैक्षिक उत्कृष्टता प्राप्त करना केन्द्रीय विद्यालय संगठन की सर्वोच्च वरीयता है। हमारे विद्यार्थी, शिक्षक एवं शैक्षिक नेतृत्व कर्ता निरंतर उन्नति हेतु प्रयासरत रहते हैं। राष्ट्रीय शिक्षा नीति 2020 के संदर्भ में योग्यता आधारित अधिगम एवं मूल्यांकन संबन्धित उद्देश्यों को प्राप्त करना तथा सीबीएसई के दिशा निर्देशों का पालन, वर्तमान में इस प्रयास को और भी चुनौतीपूर्ण बनाता है।

केन्द्रीय विद्यालय संगठन के पांचों **आंचलिक शिक्षा एवं प्रशिक्षण संस्थान** द्वारा संकलित यह 'विद्यार्थी सहायक सामग्री' इसी दिशा में एक आवश्यक कदम है। यह सहायक सामग्री कक्षा 9 से 12 के विद्यार्थियों के लिए सभी महत्वपूर्ण विषयों पर तैयार की गयी है। केन्द्रीय विद्यालय संगठन की 'विद्यार्थी सहायक सामग्री' अपनी गुणवत्ता एवं परीक्षा संबंधी सामग्री-संकलन की विशेषज्ञता के लिए जानी जाती है और अन्य शिक्षण संस्थान भी इसका उपयोग परीक्षा संबंधी पठन सामग्री की तरह करते रहे हैं। शुभ-आशा एवं विश्वास है कि यह सहायक सामग्री विद्यार्थियों की सहयोगी बनकर सतत मार्गदर्शन करते हुए उन्हें सफलता के लक्ष्य तक पहुंचाएगी।

शुभाकांक्षा सहित।

निधि पांडे

आयुक्त, केन्द्रीय विद्यालय संगठन



EDITORIAL TEAM

**PREPARED BY
DELHI REGION**

**VETTED BY
KVS ZIET CHANDIGARH
Mr. Ishwar Dass(PGT CS)
PM SHRI KV Sector-31 Chandigarh**

INDEX

UNIT NO.	UNIT / CHAPTER NAME	PAGE No.
1	Computer Systems and Organization	8-20
2	Python Basics and Flow of Control	21- 34
2	String	35-44
2	List Manipulation	45- 52
2	Tuples	53 - 61
2	Dictionary	62 - 68
2	Introduction to Python Module	69 - 73
3	Society, Law and Ethics	74 - 99
4	Sample Question Paper Solved	100-131
5	Sample Question Paper Unsolved	110-127

Computer Science (2024-25) CLASS XI Code No. 083

Unit wise Syllabus

Unit 1: Computer Systems and Organisation

- **Basic computer organisation:** Introduction to Computer System, hardware, software, input device, output device, CPU, memory (primary, cache and secondary), units of memory (bit, byte, KB, MB, GB, TB, PB)
- **Types of software:** System software (Operating systems, system utilities, device drivers), programming tools and language translators (assembler, compiler, and interpreter), application software
- **Operating System(OS):** functions of the operating system, OS user interface
- **Boolean logic:** NOT, AND, OR, NAND, NOR, XOR, NOT, truth tables and De Morgan's laws, Logic circuits
- **Number System:** Binary, Octal, Decimal and Hexadecimal number system; conversion between number systems
- **Encoding Schemes:** ASCII, ISCII, and Unicode (UTF8, UTF32)

Unit 2: Computational Thinking and Programming - I

- **Introduction to Problem-solving:** Steps for Problem-solving (Analyzing the problem, developing an algorithm, coding, testing, and debugging), representation of algorithms using flowchart and pseudocode, decomposition
- **Familiarization with the basics of Python programming:** Introduction to Python, Features of Python, executing a simple “hello world” program, execution modes: interactive mode and script mode, Python character set, Python tokens(keyword, identifier, literal, operator, punctuator), variables, concept of l-value and r-value, use of comments
- **Knowledge of data types:** Number(integer, floating point, complex), boolean, sequence(string, list, tuple), None, Mapping(dictionary), mutable and immutable data types.
- **Operators:** arithmetic operators, relational operators, logical operators, assignment operators, augmented assignment operators, identity operators (is, is not), membership operators (in not in)
- Expressions, statement, type conversion, and input/output: precedence of operators, expression, evaluation of an expression, type-conversion (explicit and implicit conversion), accepting data as input from the console and displaying output.
- Errors- syntax errors, logical errors, and run-time errors
- **Flow of Control:** introduction, use of indentation, sequential flow, conditional and iterative flow
- **Conditional statements:** if, if-else, if-elif-else, flowcharts, simple programs: e.g.: absolute value, sort 3 numbers and divisibility of a number.
- **Iterative Statement:** for loop, range(), while loop, flowcharts, break and continue statements, nested loops, suggested programs: generating pattern, summation of series, finding the factorial of a positive number, etc.
- **Strings:** introduction, string operations (concatenation, repetition, membership and slicing), traversing a string using loops, built-in functions/methods–len(), capitalize(), title(), lower(), upper(), count(), find(), index(), endswith(), startswith(), isalnum(), isalpha(), isdigit(), islower(), isupper(), isspace(), lstrip(), rstrip(), strip(), replace(), join(), partition(), split()
- **Lists:** introduction, indexing, list operations (concatenation, repetition, membership and slicing), traversing a list using loops, built-in functions/methods–len(), list(), append(), extend(), insert(), count(), index(), remove(), pop(), reverse(), sort(), sorted(), min(), max(), sum(); nested lists, suggested programs: finding the maximum, minimum, mean of numeric values stored in a list; linear search on list of numbers and counting the frequency of elements in a list.
- **Tuples:** introduction, indexing, tuple operations (concatenation, repetition, membership and slicing); built-in functions/methods – len(), tuple(), count(), index(), sorted(), min(), max(), sum(); tuple assignment, nested tuple; suggested programs: finding the minimum, maximum, mean of values stored in a tuple; linear search on a tuple of numbers, counting the frequency of elements in a tuple.
- **Dictionary:** introduction, accessing items in a dictionary using keys, mutability of a dictionary (adding a new term, modifying an existing item), traversing a dictionary, built-in functions/methods – len(), dict(), keys(), values(), items(), get(), update(), del, clear(),

fromkeys(), copy(), pop(), popitem(), setdefault(), max(), min(), sorted()); Suggested programs: count the number of times a character appears in a given string using a dictionary, create a dictionary with names of employees, their salary and access them.

- **Introduction to Python modules:** Importing module using 'import <module>' and using from statement, importing math module (pi, e, sqrt(), ceil(), floor(), pow(), fabs(), sin(), cos(), tan()); random module (random(), randint(), randrange()), statistics module (mean(), median(), mode()).

Unit 3: Society, Law and Ethics

- Digital Footprints
- Digital Society and Netizen: net etiquettes, communication etiquettes, social media etiquettes
- **Data Protection:** Intellectual property rights (copyright, patent, trademark), violation of IPR (plagiarism, copyright infringement, trademark infringement), open source software and licensing (Creative Commons, GPL and Apache)
- Cyber Crime: definition, hacking, eavesdropping, phishing and fraud emails, ransomware, cyber trolls, cyber bullying
- **Cyber safety:** safely browsing the web, identity protection, confidentiality
- **Malware:** viruses, trojans, adware
- **E-waste management:** proper disposal of used electronic gadgets.
- Information Technology Act (IT Act)
- Technology and society: Gender and disability issues while teaching and using computers

1. Practical

S.No.	Unit Name	Marks (Total=30)
1.	Lab Test (12 marks)	
	Python program (60% logic + 20% documentation + 20% code quality)	12
2.	Report File + Viva (10 marks)	
	Report file: Minimum 20 Python programs	7
	Viva voce	3
3.	Project (that uses most of the concepts that have been learnt)	8

2. Suggested Practical List of Python Programming:

- Input a welcome message and display it.
- Input two numbers and display the larger / smaller number.
- Input three numbers and display the largest / smallest number.
- Generate the following patterns using nested loops:

Pattern-1	Pattern-2	Pattern-3
*	12345	A
**	1234	AB
***	123	ABC
****	12	ABCD
*****	1	ABCDE

- Write a program to input the value of x and n and print the sum of the following series:
 - $1 + x + x^2 + x^3 + x^4 + \dots x^n$
 - $1 - x + x^2 - x^3 + x^4 - \dots x^n$
- Determine whether a number is a perfect number, an Armstrong number or a palindrome.
- Input a number and check if the number is a prime or composite number.
- Display the terms of a Fibonacci series.
- Compute the greatest common divisor and least common multiple of two integers.
- Count and display the number of vowels, consonants, uppercase, lowercase characters in string.
- Input a string and determine whether it is a palindrome or not; convert the case of characters in a string.
- Find the largest/smallest number in a list/tuple
- Input a list of numbers and swap elements at the even location with the elements at the odd location.
- Input a list/tuple of elements, search for a given element in the list/tuple.
- Create a dictionary with the roll number, name and marks of n students in a class and display the names of students who have marks above 75.

3. Suggested Reading Material

- NCERT Textbook for Computer Science (Class XI)
- Support Material on CBSE website.

Distribution of Marks

Unit No.	Unit Name	Marks	Periods	
			Theory	Practical
1	Computer Systems and Organisation	10	10	10
2	Computational Thinking and Programming -1	45	80	60
3	Society, Law, and Ethics	15	20	—
	Total	70	110	70

Unit - 1 (Computer System and Organisation)

Computer System

A computer is an electronic device which consists of hardware and software. Hardware components describe the physical parts of the computer and software controls hardware and run the operating system, different programs & applications like Microsoft Windows, Microsoft word, Microsoft Excel etc.

Below is the block diagram of Computer System

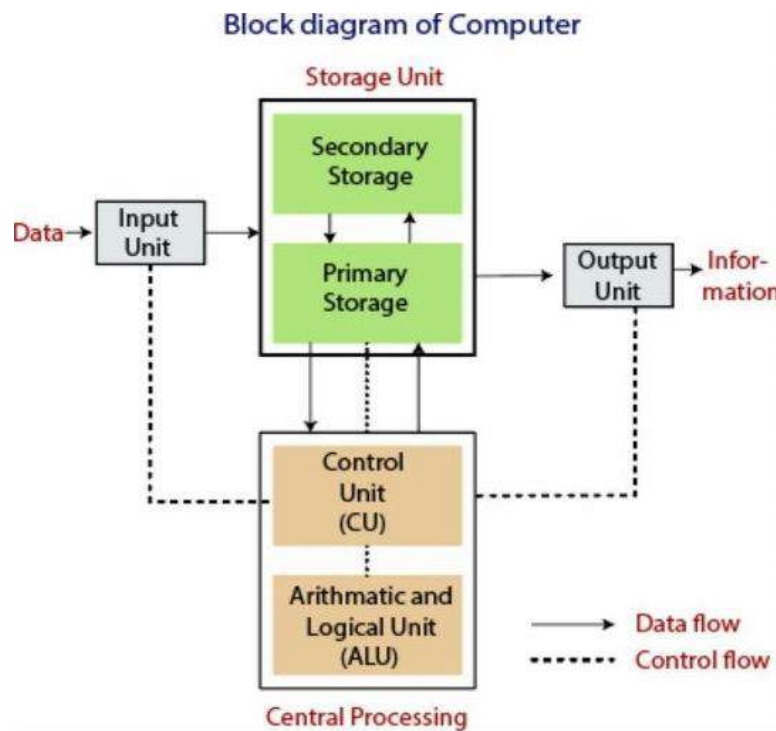

Strengths of Computer:

- A computer is much faster as compared to human beings.
- Computers are more accurate than a human for solving any problem.
- They are immune to tiredness and boredom or fatigue.
- Computers can perform repetitive jobs efficiently.

Weaknesses of Computer:

- Computer cannot take decisions on its own.
- It needs to be told at each and every step to perform any certain tasks.
- The computer doesn't have human-like feelings.

A computer works on the IPO principle i.e. Input -> Process -> Output.

A computer receives data as input, processes it, stores it, and produces output based on this, computer uses some components to take input, some components to do processing and some components to provide output.

Input Device: The devices which are used to input the data and programs in the computer are known as "Input Devices". Input unit accepts instructions and data from the user and converts

these instructions and data in computer acceptable format which are sent to computer system for processing. Some examples of input devices include keyboard, mouse, scanner, touch screen, etc.

Output Device: Output Device produces the final results of computer into human understandable form. Output unit accepts the results produced by the computer which are in coded form and it converts these coded results to human readable form. For example, monitor, projector, headphone, speaker, printer, etc.

Central Processing Unit (CPU): It is known as the brain of the computer. It has three main components:

- **Control Unit (CU):** It controls and guides interpretation, flow and manipulation of data and information. It sends control signals until the required operations are properly done by ALU and memory unit (storage unit).
- **Arithmetic and Logic Unit (ALU):** It performs all the required arithmetic and logical operations to perform the task.
- **Memory Unit (Storage Unit):** It comprises of primary and secondary memory units.

Hardware: All the physical components of the computer system are known as hardware e.g., keyboard, mouse, monitor, printer, etc.

Software: A set of instructions that directs a computer to perform specific tasks or operations. Computer software consists of computer programs and libraries.

Software can be classified into three types:

- **System Software:** This software is mandatory for all computer systems to work. For example: Operating systems like MS-DOS, Microsoft Windows etc.
- **Application Software:** This software is made to perform a specific task, For example: WordPad, MS-Word, etc.
- **Utility Software:** Software that assists the computer to perform functions like data backup, virus removal, scanning, defragmenting, etc. For example: Antivirus, Disk defragmenter, etc.

Memory Units

Classification of Computer Memory

A) Primary Memory: It is the internal storage that is used by our computer system to store data and instructions while processing. It is temporary memory and is volatile. It is directly accessed by the CPU. It is of two types viz. RAM and ROM.

1. RAM: It is an acronym for Random Access Memory. It is a type of Primary memory and is also known as read and write memory as it can be used for both purposes.

It can be of the following two types:

(i) SRAM: It is an acronym for Static Random Access Memory. It is a type of memory that requires a constant power supply to hold the data and information. These are made of flip-flops.

(ii) DRAM: It is an acronym for Dynamic Random Access Memory. The term dynamic indicates that the memory is constantly needed to be refreshed otherwise it loses its contents. It is the most common kind of RAM used in personal computers. These are made of transistors and capacitors.

2. ROM: It is an acronym for Read Only Memory. It provides non-volatile storage of data. We can access any memory location of ROM by supplying its address.

B) Secondary Memory: It is also known as external memory or non-volatile memory. It is slower than main memory. These are used for storing data or information permanently. For example: hard disk, CD-ROM, DVD etc.



1. **Compact Disc (CD):** It is an optical media that is used for electronically recording, storing and playing back audio, video, text and other information in digital form.
2. **Digital Video Disc (DVD):** It is also known as Super Density Disc(SDD) or Digital Versatile Disc(DVD). In appearance, they are somewhat similar to CDs but they have comparatively more storage capacities than that of CD.
3. **Pen drive:** It is a storage device that includes flash memory with an integrated Universal Serial Bus (USB) interface. These are typically removable and rewritable and physically much smaller than an optical disc.
4. **Blu-ray Disc (BD):** It is a digital optical disc data storage format designed to supersede the DVD format. It is capable of storing high-definition video resolution (1080p). It uses a blue-violet laser to read and writes data with high precision. Its storage capacity is up to 50 GB.

C) Cache Memory: Cache memory is a very high speed semiconductor memory which can speed up CPU. It acts as a buffer between the CPU and main memory. It is used to hold those parts of data and program which are most frequently used by CPU.

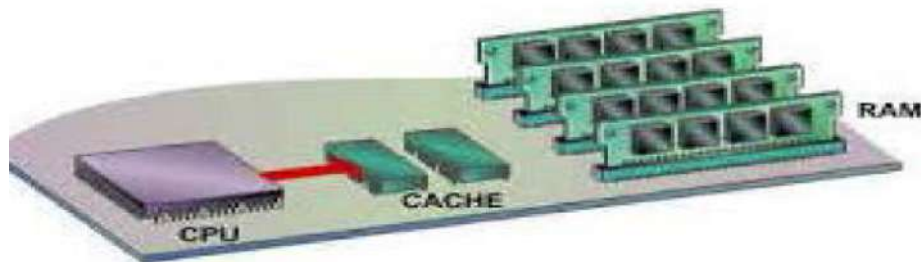

Advantages

The advantages of cache memory are as follows:

- Cache memory is faster than main memory.
- It consumes less access time as compared to main memory.
- It stores the program that can be executed within a short period of time.
- It stores data for temporary use.

Disadvantages

The disadvantages of cache memory are as follows:

- Cache memory has limited capacity.
- It is very expensive

The smallest unit is bit, which mean either 0 or 1.

1 bit = 0 or 1

1 Byte = 8 bit

1 Nibble = 4 bit

1 Kilo Byte = 1024 Byte= 2^{10} Byte

1 Mega Byte = 1024 KB= 2^{10} KB

1 Gega Byte = 1024 MB= 2^{10} MB
1 Tera Byte = 1024 GB= 2^{10} GB
1 Peta Byte =1024 TB= 2^{10} TB
1 Exa Byte =1024 PB= 2^{10} PB
1 Zetta Byte = 1024 EB= 2^{10} EB
1 Yotta Byte = 1024 ZB= 2^{10} ZB

Input – Output (I/O) Devices

Input Devices

- Input unit is used to accept data and instructions from the user.
- Keyboard is used to type in letters, digits and commands.
- Mouse is a pointing input device.
- Microphone is used to send input to the computer.
- A scanner creates an electronic form of the printed image. Scanner are of three type: Handheld, Flatbed and Drum.
- A touch screen can detect where on the screen surface you are touching.
- A barcode reader is a handheld device that is used to obtain data contained in a bar code.
- Light pen is a handheld electro optical pointing device which is used for making drawings, graphics and for menu selection.

Output Devices

- Output unit is responsible for producing the output in user-readable form.
- Monitor displays information in a way similar to that shown on a television screen.
- The picture on a monitor is made up of thousands of tiny coloured dots called pixels.
- CRT (Cathode Ray Tube) contains an electron gun at the back of the glass tube.
- Liquid Crystal is a material used to create each pixel on the screen in LCD.
- TFT (Thin Film Transistor) is the device within each pixel that sets the charge.
- PDP (Plasma Display Panels) are flat panel displays.
- Plasma technology utilises small cells containing electrically charged ionised gases.
- Printer prints information and data from the computer onto a paper.
- Printer are divided into two categories: impact printer and Non-impact printer.
- Speakers receive the sound in form of electric current from the sound card.
- The Plotter is a graphic output device used to create drawings on paper.

Port: It is a connection point of interface between a computer and internal or external devices. Some common types of ports are - Serial Port, USB Port, Bluetooth, IR port etc.

Serial Port: Serial port is also known as COM Ports (communication ports).These are used to connect devices such as mouse, modem, etc. In this type of ports, only 1 bit of information can travel at a time.

Parallel Port: Parallel port is a type of port in which data are sent and received simultaneously over several parallel channels. It can transfer up to 8 bits of data at a time. It is used to connect peripheral devices such as printer.

USB Port: USB Port is an acronym for Universal Serial Bus Port. It comes under a serial port and is used for short distance digital data communication. It allows data transfer between devices with little electric power.

PS/2 Port: PS/2 Port is a type of port developed by IBM for connecting a mouse or a keyboard to the computer.

Infrared Port: Infrared Port is also known as an IR port. It is a meta port that sends and receives infrared signals from other infrared-enabled devices.

Software Concept

It represents the set of programs that governs the operations of a computer system and make the hardware run smoothly.

Types of Software

(i) System Software: These softwares are mandatory for all computer systems to work. For example: Operating Systems like Windows and language processors like assembler, etc.

(ii) Application Software: These softwares are made to perform a specific task. For example: WordPad, MS-Word, etc.

(iii) Utility Software: It is used to perform some additional functions which make our computer safer, secure and work smoothly

UTILITY SOFTWARE

Utility Software is used to perform some additional functions which makes our computer more safe, secure and work smoothly. Utility software is considered to be a part of system software. For example, antivirus, disk defragmenter, etc.

(i) Antivirus: it is utility software which detects and removes computer viruses. The antivirus keeps a watch on the functioning of the computer system.

(ii) Disk Defragmenter: it scans the hard disk for fragmented files and brings all the fragments together.

(iii) Backup Utility: It is used to create the copy of the complete or partial data stored in a disk or CD on any other disk. In case the hard disk crashes or some other system failure occurs, the files can be restored using backup software.

(iv) Compression Utility: It is used to compress large files. Compression is useful because it helps reduce resources usage and the file transmission on the network becomes easier.

(v) Disk Cleaner: It scans for files that have not been accessed/used since long. Such files might be occupying huge amount of memory space.

(vi) File Management Tools: It helps the user in storing, indexing, searching and sorting files and folders on the system. e.g. Windows Explorer.

SYSTEM SOFTWARE:

(i) Operating System (OS): It is a system program that acts as an interface between user and the machine. It allocates and manages the resources of the computer.

(ii) Language Translators: It is a program used to convert a program written in HLL(High Level Language) or assembly language to machine language.

(a) Compiler: It is a system program which translates a program written in a high level language into its equivalent program in machine language.

(b) Interpreter: Interpreter converts a HLL program into equivalent machine language program one line at a time and executing it, if no error is encountered.

(c) Assembler: Assembler is a system program that converts an assembly language program into the machine language of the host computer.

(iii) Device Drivers: It is a program that controls a particular type of device that is attached externally to a computer.

APPLICATION SOFTWARE

(i) General Purpose Application Software: A software which is made for the common users for day to day application and uses. Example: **Word Processor, Presentation Tools, Spreadsheet Packages, Database Management System , Graphics Software.**

(ii) Special or Specific-Purpose (Customised Software): those software which have been developed for a user for task which is very specific to them.

- **Customised Software , Payroll Management System, Hotel Management etc.**

A **programming tool** or software development tool is a computer program that software developers use to create, debug, maintain, or otherwise support other programs and applications.

Operating System (OS)

It is defined as a collection of programs that coordinates the operations of computer hardware and software. It acts as a bridge or the interface between man and machine.

Functions of an Operating System

- **Device management:** Operating system ensures the smooth functioning of all the peripheral devices.
- **Processor management:** Operating system enables the activities of planning, performing and monitoring the performance of any process.
- **Memory management:** It is the act of managing memory i.e., provide required memory for the process to happen and then save the desired result back in the memory.
- **File management:** This function of operating system allows the user to create a file, write into it, open it for reading, close it after reading or writing is over and delete it, if it is not required any more.

Types of Operating Systems

- **Real Time Operating System (RTOS):** RTOS is a multi-tasking operating system that aims to execute real time applications. It is designed to respond to an event within a predetermined time. These are used to control machinery, scientific instruments and industrial systems.
For example: Windows CE, Linux, etc.
- **Multi user operating system:** It is the type of operating system that allows many users to take the advantage of computer's resources simultaneously.
For example: UNIX, VMS, etc.
- **Single user operating system:** Single user operating system is designed for one user to effectively use a computer at a time.
For example: Windows 2007, Windows 10, etc.
- **Single tasking operating system:** It is an operating system which can run only one program at a time. **For example:** Palm
- **Multi-tasking operating system:** This operating system allows the execution of multiple tasks at a time.
For example: Windows 2007/2008/2009 /XP, etc.
- **Time sharing operating system:** It allows the users to share the computer resources simultaneously.
For example: A mainframe computer that has many users logged on to it.
- **Distributed operating system:** Distributed operating system uses multiple central processors to serve multiple real time applications.

User Interface

The feature of a computer system which allows the user to interact with it.

There are two prevalent types of user interface:

- **Command Line Interface:** It requires users to type appropriate instructions into the command line.
- **Graphical User Interface:** GUI is the type of interface in which user interacts by using a mouse or other peripheral to point and click on graphics or icons.

Questions to Solve:

A) Identify the following peripherals as INPUT device or OUTPUT device.

1. Monitor _____
2. Keyboard _____
3. Scanner _____
4. Laser Printer _____
5. Mouse _____
6. Speakers _____
7. Digital Camera _____

B) Fill in the blank with the correct answer from the box. Some may be used more than once or not at all.

CPU	BIOS	power supply	hard drive	network card
Motherboard	RAM	USB Port	ROM	video card

1. I connect computers and allow them to talk to each other. _____
2. I wake up the computer and remind it what to do. _____
3. I am the brain of the computer. _____
4. Information is stored on my magnetic cylinders. _____
5. I hold all of the other circuit boards. _____
6. I handle the graphics that are displayed on the monitor. _____
7. I am the type of port used by flash drives _____

C) Fill in the blanks with the vocabulary words from the box. Use each word only once.

information	flash drive	CD	primary	DVD	secondary
Windows	operating system	graphics	upgraded	user friendly	

1. _____ memory is stored on chips located on the motherboard.
2. _____ memory is stored on the hard drive.
3. A _____ can hold information greater than a CD or DVD.
4. A _____ usually holds up to 650 to 700 MB.
5. A _____ holds even more information at least 7 GB.
6. The purpose of storage in a computer is to hold _____ or data.
7. A computer that is easy to operate is called _____ .
8. _____ is the most common operating system for PCs.
9. Operating systems are constantly being _____ as technology advances.
10. A Graphical User Interface (GUI) uses _____ to help the user navigate within the computer system.

Short Answer Type Questions with solution:

Q1. Write the full form of ASCII.

Ans: American Standard Code for Information Interchange

Q2. Differentiate between Interpreter and Compiler.

Ans: An interpreter converts HLL program into machine language line by line and simultaneously executes the converted line. A compiler converts an HLL into machine language in one go.

Q3. What is the difference between RAM and ROM?

Ans:

RAM	ROM
Random Access Memory.	Read Only Memory.
It is Volatile or temporary memory.	It is Non Volatile or permanent memory
Data gets erased when power supply off.	Data stored permanently.
Faster memory.	Slow memory.
It is used in the normal operations of a computer after starting up and loading the operating system.	A ROM chip is used primarily in the start-up process of a computer.

Q4. What is a language processor? Write the name of two language processors.

Ans. A **language processor** is a software program for processing program code to machine code. Ex, Compiler, Interpreter.

MCQ Type Questions:

Q1. Which smaller unit of CPU directs and coordinates all activities within it and determines the sequence in which instructions are executed, sending instructions sequence to other smaller unit.

- a) CU b) ALU c) Processor d) All of the above

Q2. Which is not Secondary Storage Device?

- a) RAM b) ROM c) Cache Memory d) All of the above.

Q3. Which is not Utility Software?

- a) MS Office b) Antivirus c) Disk Cleanup d) Compression Tools

Q4. Which is not Language Processor?

- a) Assembler b) Compiler c) Interpreter d) Disk Defragmenter

Q5 MICR stands for?

- a) Magnetic Ink Character Reader b) Magnetic Ink Code Reader
c) Magnetic Ink Caser Reader d) Magnetic Ink Computer Reader

Q6. When we work on any document on PC, it is stored temporarily in ___ memory

- a) RAM b) ROM c) CPU d) CD-ROM

Q7. What do you call a program in execution?

- a). Command b) Process c) Task d) Instruction

Q8. Which of the following is not an operating system?

- a). Windows b) Linux c) Oracle d) DOS

Q9 Which is not Secondary Storage Device?

- a). RAM b) ROM c) Cache Memory d) All of the above

Q10. Which is not Language Processor?

- a). Assembler b) Compiler c) Interpreter d) Disk Defragmenter

Long Answer Type Question:

- Q1. Explain the types of Memory of Computer with example.
- Q2. What do you mean by Firmware? Explain the use of BIOS?
- Q3. What is computer? Explain the main components of computer system with block diagram ?
- Q4. Explain types of Computer based on size and performance with example?
- Q5. What is the difference between Multi user Operating System and Multi processing Operating System.
- Q6. What is Operating System? Explain the functions of Operating System?
- Q7. What is ROM? Explain about different types of ROM.
- Q8. What do you mean by Peripheral Device? Name two Peripheral Devices of Computer?
- Q9 Explain following Terms?
- Printer
 - Keyboard
 - Mouse
 - Arithmetic Logic unit
- Q10. Which of the following is designed to control the operations of a computer?
- Application Software
 - System Software
 - Utility Software
 - User

BOOLEAN ALGEBRA

It is developed by George Boole in 1854 and deals with binary values and logical operations and hence is also known as **Binary Algebra** or **Logical Algebra**. It helps us in analysing and simplifying the digital circuits.

Boolean Algebra uses three basic logical operators:-

- **NOT operator** – It operates on single input and gives complement of the input as output. Thus if $A = 0$, then $A' = 1$ and vice versa.
- **OR operator** – It is a binary operator equivalent to a logical (+) addition. Thus $A + B$ implies **A OR B**. This operator gives a true (i.e. 1) if any of the operand is True or 1.
- **AND operator** – It is a binary operator equivalent to logical (·) multiplication. Thus $A \cdot B$ implies **A AND B**. It gives a true (i.e. 1) only if both the operands are True or 1.

A logical variable can take only two values i.e. either a binary 1 or a binary 0. While evaluating Boolean expression the order of evaluation of logical operators is NOT, AND then OR, Parenthesis is evaluated first.

Truth Table – It is tabulated form of all the possible input combinations and their respective outputs. The number of possible input combinations for a Boolean expression is 2^n , where n is the number of input variables. Hence, for a Boolean function $F(A,B)$, number of possible combinations will be 4 and for a Boolean function $F(A,B,C,D)$ it will be 16.

Basic Rules (Postulates) of Boolean Algebra

- $X + 0 = X$ or $0 + X = X$
- $X + 1 = 1$ or $1 + X = 1$
- $X \cdot 0 = 0$
- $X \cdot 1 = X$

De Morgan's theorems

(i) $\overline{A \cdot B} = \overline{A} + \overline{B}$

(ii)

$\overline{A + B} = \overline{A} \cdot \overline{B}$

The dual principle or principle of duality says that the Boolean algebra remains unchanged when the dual pairs are interchanged. But nothing goes with complement because complement is self-dual operation.

Principle of Duality states that starting with a Boolean relation, another Boolean relation can be derived by

1. Changing each OR sign (+) to an AND sign (·).
2. Changing each AND sign (·) to an OR sign (+).
3. Replacing each 0 by 1 and each 1 by 0.

Logic circuit, electric circuit whose output depends upon the input in a way that can be expressed as a function in symbolic logic; it has one or more binary inputs and a single binary output. Logic circuits that perform particular functions are called **logic gates**.

• **NOT Gate** is an inverter circuit that operates on single input. It gives complement of the input as the output. It is represented by the following symbol.

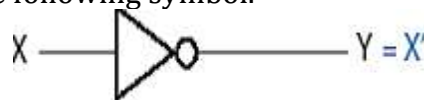

AND Gate gives a high output if both the inputs are high. Algebraically it is represented by a (·) dot. Its electronic symbol is

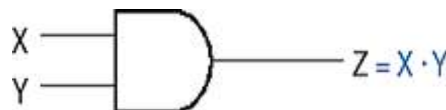

OR Gate gives a high input if any one of the inputs is high. Its algebraic symbol is (+) Plus, and electronically it is represented as

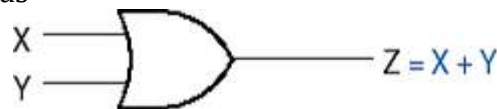

NAND Gate is inverter of AND gate. It gives a High Input if any of the inputs is low. Its symbol is AND Gate with a small circle at the output implying inversion.

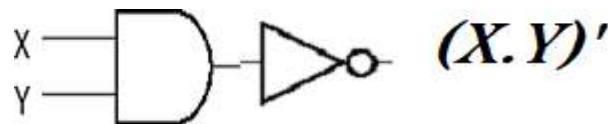

NOR Gate is inverter of OR. Its output is low if any of the inputs is high. Its symbol is OR Gate with a small circle at the output implying inversion.

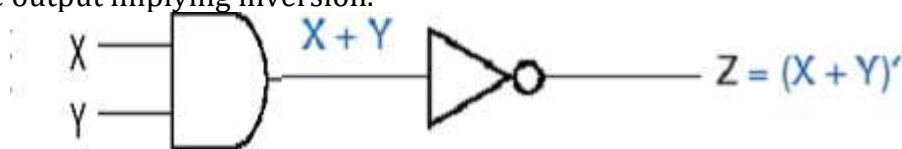

XOR Gate gives a high output if odd number of inputs is high. It is used to detect the mismatch of bits. Its algebraic symbol is \oplus .

XNOR Gate gives a high output when both the inputs are same i.e., either both are high or both are low.

Tautology: It is an expression or assertion that is always true.

Fallacy: An expression that always yields 0 or false is called Fallacy.

Universal gates – NAND and NOR gates are known as universal gates as any possible circuit can be built using these two gates.

Questions:

Q1. Which is Universal Gate?

- a) AND Gate b) OR Gate c) NOR Gate d) NOT Gate

Q2. Which gate returns true if both inputs are similar otherwise false.

- a) NAND b) NOR c) XOR d) None of the above

Q3. Which of the following is / are the universal logic gates?

- a) OR and NOR b) AND c) NAND and NOR d) NOT

Q4. Write the equivalent Boolean expression for the following Logic circuit.

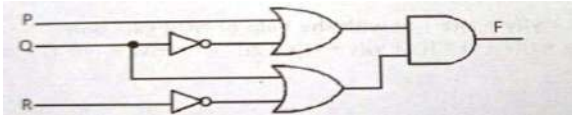

- a) $(P+Q).(Q+R)$ b) $(P'+Q).(Q+R')$ c) $(P'+Q).(Q'+R)$ d) $(P'+Q).(Q'+R')$

Q5. DE Morgan's Law states that

- a) $(AB)' = A' + B'$ b) $(A+B)' = A' * B$ c) $(A'+B') = A'.B'$ d) $(AB)' = A'+B$

Q6. Draw a Logic Diagram of given Boolean Expression

$$F(X,Y,Z) = ((X'+Y).(X+Y'+Z))'$$

Q7. Draw Truth Table of given Boolean Expression

$$F(A,B,C) = ((A.B)+C)(A+C)$$

Q8. Draw the logic circuit diagram for the expression:

$$X=AB'+B'C'+ABC.$$

Q9. Write the truth table for NOR gate.

Q10. Construct the logic circuit of the given Boolean Expression?

$$F(A, B, C, D) = (A+B) C + (ABCD)' + (AB)'+CD$$

NUMBER SYSTEM AND ENCODING SCHEMES

Number System

A set of values used to represent different quantities is known as number system.

The four most common number systems are:

- (1) **Decimal Number System:** The decimal number system has base or radix 10 because it uses ten digits from 0 to 9.
- (2) **Binary Number System:** The Base-2 number system is also famously known as the Binary Number System wherein only two binary digits exist, i.e., 0 and 1.
- (3) **Octal Number System:** Octal number system has only eight (8) digits from 0 to 7. The base of octal number system is 8, because it has only 8 digits.
- (4) **Hexadecimal Number System:** A Hexadecimal number system has sixteen (16) alphanumeric values from 0 to 9 and A to F. The base of hexadecimal number system is 16, because it uses 16 alphanumeric values. Here A is 10, B is 11, C is 12, D is 13, E is 14 and F is 15.

Number system	Base(Radix)	Used digits	Example
Binary	2	0,1	(11110000) ₂
Octal	8	0,1,2,3,4,5,6,7	(360) ₈
Decimal	10	0,1,2,3,4,5,6,7,8,9	(240) ₁₀
Hexadecimal	16	0,1,2,3,4,5,6,7,8,9, A,B,C,D,E,F	(F0) ₁₆

Relation between various number systems is given below:

Conversion between Number Systems.

Decimal	Binary	Octal	Hexadecimal
76	1001100	114	4C

Let's break down each conversion:

1. Binary (Base 2):

- To convert decimal 76 to binary:

- Divide 76 by 2:
- $76 / 2 = 38$ remainder 0
- $38 / 2 = 19$ remainder 0
- $19 / 2 = 9$ remainder 1
- $9 / 2 = 4$ remainder 1
- $4 / 2 = 2$ remainder 0
- $2 / 2 = 1$ remainder 0
- $1 / 2 = 0$ remainder 1 (stop here)

- Reading remainders from bottom to top gives us: 1001100

2. Octal (Base 8):

- To convert decimal 76 to octal:

- Divide 76 by 8:
- $76 / 8 = 9$ remainder 4
- $9 / 8 = 1$ remainder 1
- $1 / 8 = 0$ remainder 1 (stop here)

- Reading remainders from bottom to top gives us: 114

3. Hexadecimal (Base 16):

- To convert decimal 76 to hexadecimal:

- Divide 76 by 16:
- $76 / 16 = 4$ remainder 12 (which is C in hexadecimal)

- $4 / 16 = 0$ remainder 4 (stop here)
- Reading remainders from bottom to top gives us:
- Therefore, 76 in hexadecimal is 4C.

Conversion from Decimal to Any Number: Use Division method: Dividing Decimal Number by base of number in which we have to convert and write down remainder in reverse order.

Any other Number to Decimal Number: Multiply each digit with the positional power of the base which is converting to decimal.

Conversion from Binary / Octal / Hexadecimal to Binary / Octal / Hexadecimal: use bit Combination method for Octal – 3 bit and for Hexadecimal – 4 bit Combination.

Method of one's complement: One complement of a binary number is found by inverting the zero and one's without changing the number of digits.

1's complement of 111001 is 000110

Method of two's complement: Two's complement of a binary number is found by adding 1 to its one's complement.

Steps:

- At first 2's complement of the subtrahend is found.
- Then it is added to the minuend.
- If the final carry over of sum is 1 it is dropped and result is positive
- If there is no carry over, the 2's complement of sum will be the result and it is negative.

e.g 10110 – 11010

2's complement of 11010 is (00101 + 1)

i.e., 00110

Hence minuend 1 0 1 1 0

2's complement of subtrahend + 0 0 1 1 0

1 1 1 0 0

As there is no carry over, the result of subtraction is negative and is obtained by writing the 2's complement of 11100 i.e., (000110 + 1) or 00100

Hence the difference is – 100

Encoding Schemes

Integers may be represented in various ways in computers. These are

- (a) Sign and magnitude representation
- (b) One's complement, Two complement

Some of the main computer codes are:

- (i) **ASCII Code:** American Standard Code for Information Interchange. It is a 7-bit code so it has 2^7 — 128 possible code groups.
- (ii) **ISCII Code:** Indian Standard Code for Information Interchange. It is a 8-bit code so it has $2^8=$ 256 possible code groups. It retains all ASCII characters and offers coding for Indian characters also.
- (iii) **UNICODE:** It is the new universal coding standard being adopted by all newer platforms. Unicode provides a unique number for every character, no matter what the platform or program or the language is. Commonly used UNICODE encodings are UTF-8, UTF-16 and UTF-32. It is a superset of ASCII, and the values 0–128 have the same character as in ASCII.

Questions:

- Q1. The hexadecimal digits are 1 to 0 and A to ____?
- a) E b) F c) G d) D
- Q2. ASCII is a _____ bit code and ISCII is a _____ bit code.
- a) 8, 7 b) 7, 8 c) 8, 8 d) 7, 7
- Q3. According to the distributive law $A(B+C) =$ _____.
- a) ABC b) AB+AC c) A+B+C d) A+BC
- Q4. Convert the following: (i) $(4A)_{16} = (\quad)_2$ (ii) $(106)_{10} = (\quad)_8$
- Q5. Convert the decimal number 106 to
- a) binary and b) octal.
- Q6. ASCII uses ___ bits to represent Characters.
- a) 5 b) 6 c) 7 d) 8
- Q7. How many bits forms a Kilo Byte?
- a) 8194 Bits b) 8192 bits c) 4096 bits d) 1024 bits
- Q8. Convert the following number in to given numbers:
- a) $(345.24)_{10} = (\quad)_2$ b) $(A35.57)_{16} = (\quad)_8$
- Q9. Convert the following numbers in the given equivalent number system.
- a). $(234.56)_{10} = (\quad)_2$ b) $(1101111.11011)_2 = (\quad)_{16}$
- Q10. Full form of USB
- a) Uniform Service Bus b) Universal Serial Bus c). Universal Sector Buffer d) Universal Service Bus

Unit – 2 (Computational Thinking and Programming)

Problem and Problem Solving

In computer science, "problem" refers to a task or challenge that requires a solution. The process of identifying a problem, developing an algorithm, and implementing an algorithm to develop a computer program is called Problem Solving.

Steps required for solving a problem

- Analyzing the problem
- Developing an Algorithm
- Coding
- Testing and Debugging

Analyzing the Problem

This stage focuses on understanding the problem. If we do not have a clear understanding of the problem, we may develop a computer program that cannot solve the problem correctly. In this stage, we figure out the inputs, the outputs and the processing required to convert the input into the output.

Developing Algorithm

This stage focuses on creating a logical sequence of instructions, called an Algorithm. An algorithm has a distinct start and end point, as well as a defined number of steps.

Draw a flow-chart to identify whether a number taken as the input from the user is an even number or an odd number?

Algorithm	Flow Chart
------------------	-------------------

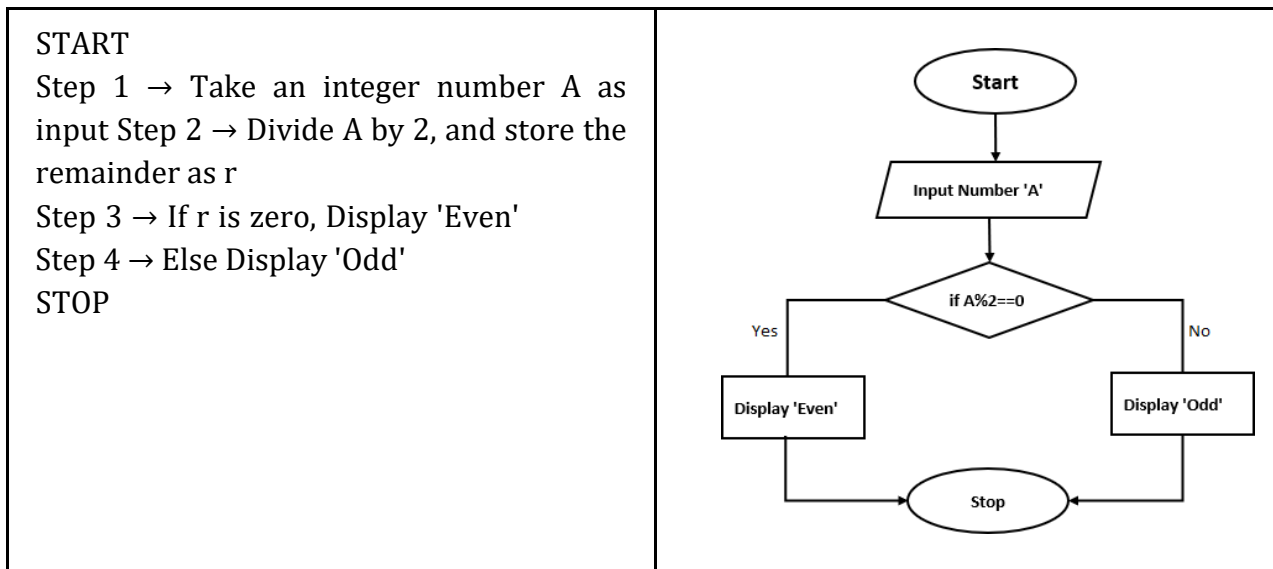

Coding

Coding is the process of creating computer programs.

Testing

Testing is a process to check if an application is working as expected. The main objective of Testing is to find errors.

Debugging

Debugging is the activity to fix the errors found in the application during the testing phase.

Representation of Algorithms

There are two common methods of representing an algorithm —flowchart and pseudocode.

Pseudocode

- Pseudocode is a way of representing an algorithm in readable and easy language.
- Pseudocode is not an actual program. So, it cannot be executed.
- Some of the frequently used keywords while writing pseudocode are INPUT, COMPUTE, PRINT IF/ELSE, START, STOP

Advantages of Pseudo-Code:

1. Easily convertible to a Programming Language
2. Easy to understand and read

Write a pseudocode for identifying if a number is even or odd.

```

INPUT number A
COMPUTE remainder as r = A%2
IF r ==0 PRINT 'Even'
ELSE PRINT 'Odd'
  
```

Decomposition

Decomposition is the process of breaking a complex computer problem into smaller parts that are easily manageable and solvable

Computer Program:

A computer program is a set of instructions written in a programming language that can be executed by the computer to perform and solve a certain task.

Python Programming Language:

Python is an interpreted, high-level programming language. It was developed by Guido van Rossum. It is user-friendly and is most popular for its easy-to-use syntax and readable code. It is case sensitive.

Working in Python

- i) Install Python on the computer (<https://www.python.org/downloads/>).
- ii) Use Python IDLE (Integrated Development and Learning Environment) for developing python Programs.

How to Display Data

print() function is used to print a message on the screen.

A Simple Hello World Program

```
print("Hello World")
```

Modes of working in Python

- Interactive Mode
- Script Mode

Interactive Mode

In Interactive Mode, a python statement is executed in a command-line shell. It provides instant feedback for each statement while keeping prior statements in memory.



Script Mode

In script mode, the instructions are saved in a file with a '.py' extension and executed from the beginning of the file. This mode is suitable for creating and running large programs.

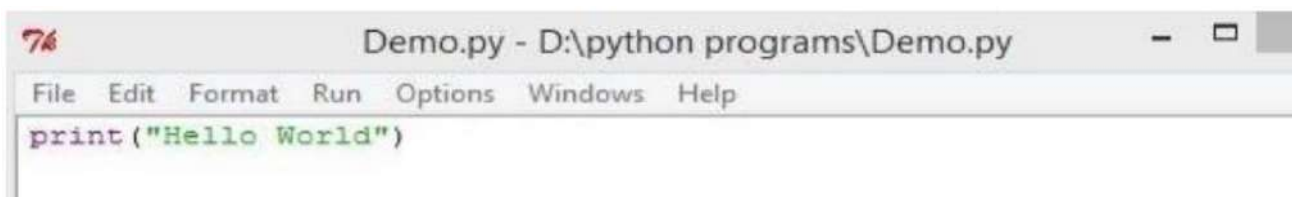

Character Set:

A character set is a collection of valid characters that can be recognized by a language. Python Language recognises the following characters as valid:

Letters : A-Z, a-z

Digits : 0-9

Special Symbol : + / @ ! - = <> == etc.

Whitespaces : '\n', '\t' etc.

Tokens

Tokens are the smallest individual units of a program.

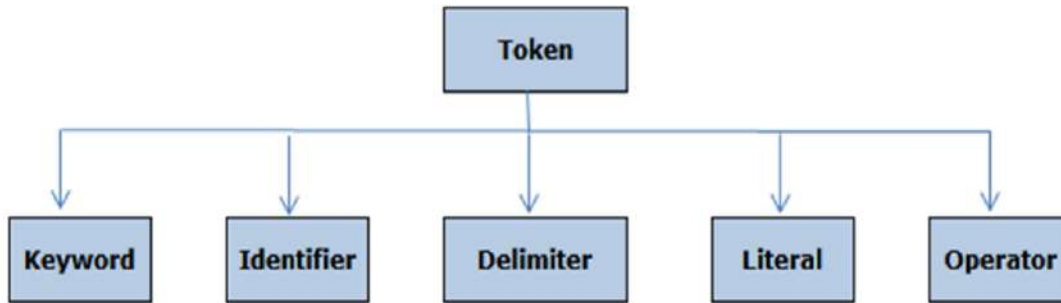

Keywords

Keywords are reserved words with special meaning (known to the interpreter). These can not be used as identifiers in a program.

Example: for, while, else, if

Identifier

A variable, function, class, module, or other objects are identified by a name known as identifier.

Rules for naming an identifier:

1. First character of a variable can be an alphabet (A-Z or a-z) or an underscore(_).
2. Next characters of a variable can be an alphabet (A-Z or a-z), an underscore(_) or a digit.
3. Keywords cannot be used as variables.
4. First character cannot be a digit.
5. Special characters including white spaces are not allowed.

Literals:

Literals are data-items that have a fixed value of a certain data type, such as a number, string, boolean, or None. They are also known as Constants.

Example :

String literals (Text) : 'Hello World'

Numeric literals (Numbers) : 3.14

Boolean literals (Truth Value) : True/False

None Literal : The None keyword is used to define a null value or absence of a value. None is different from 0.

Operators and Operands

Operators are symbols (or keywords) that perform various operations on the operands. An operand is a variable or a literal on which the operation is performed.

Example: 50 + 20

Here 50 and 20 are operands, and + is the operator.

Arithmetic Operators : Arithmetic operators perform mathematical operations like addition, subtraction, multiplication, division, floor division, exponent and modulus. (+, -, *, /, //, **, %)

Relational Operators:

Relational operators perform comparison between values. An expression having relational operators evaluates to either True or False. Example >, <, >=, <=, ==, !=

Logical Operators:

These operators are used to combine conditional statements.

Examples:

- **and:** True if both the operands are true.
- **or:** True if either of the operands is true.
- **not:** True if the operand is false (complements the operand).

Assignment Operators: These operators are used to assign values to variables.

Examples:

- **= (Assign):** Assigns the value on the right to the variable on the left.
- **+=, -=, *=, /=:** These operators combine arithmetic operations with assignment.

Membership Operators:

These operators test for membership in sequences (lists, tuples, strings).

Examples:

- **in:** True if value/variable is found in the sequence.
- **not in:** True if value/variable is not found in the sequence.

Identity Operators:

These operators compare the memory locations of two objects.

Examples:

- **is:** True if the operands are identical (refer to the same object).
- **is not:** True if the operands are not identical (do not refer to the same object).

Python Comments

Comments are descriptions about the code. They help other programmers understand the functionality of the code. Comments are ignored by the Python interpreter.

Variable

Variables refer to an object (data items like int, float, list, dictionary etc.) stored in the memory. Value stored in a variable can be changed during the program execution.

Rules for naming a variable are the same as the rules for naming an Identifier.

Concept of L Value and R Value

In Python, the l-value refers to the left-hand side of an assignment operator, while the r-value refers to the right-hand side of an assignment operator.

Consider the following assignment statement:

```
x = 5+2
```

In the statement above, the l-value is 'x' as it is on the left-hand side of the = operator.

The r-value is 7 as it is on the right-hand side of the = operator

● Knowledge of data types: Number(integer, floating point, complex), boolean, sequence(string, list, tuple), None, Mapping(dictionary), mutable and immutable data types.

Data Type

Data type represents the type of data a Variable or a Literal is referring to. Each data type has specific characteristics and operations associated with it. In Python, there are various data types, including number, string, boolean, list, tuple, and dictionary.

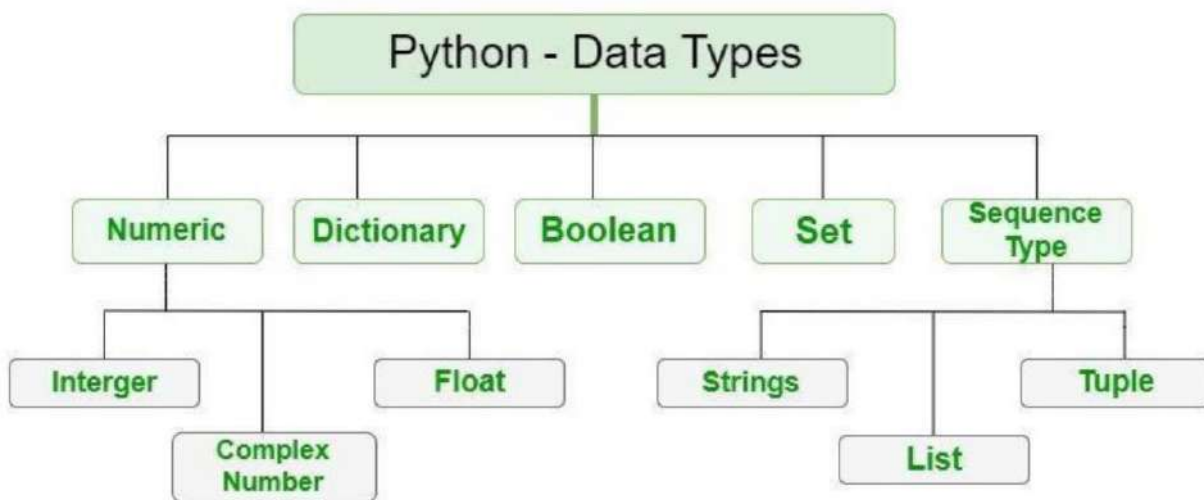

Mutable and Immutable Data Objects

Python variables are memory references. It may be required to change or update the value of an object referenced by a variable.

Mutable Objects:

Mutable data objects are objects that can be changed after they are created. It is possible to add, remove, or modify elements within these data types. Example of mutable data types: List, Set and Dictionary.

Immutable Objects :

Objects whose values cannot be changed after they are created are called immutable objects. To change the value, a new object is created. Example of immutable data types: Number (Integer, Float), String, and Tuple.

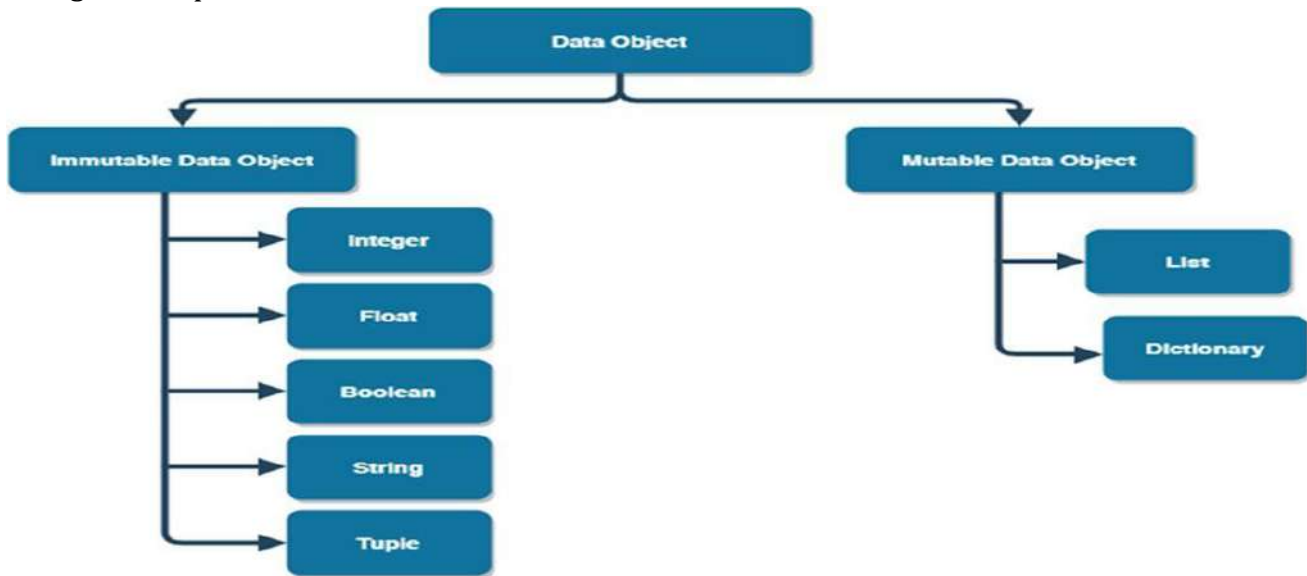

Numeric Data Types (Number)

Python has three numeric data types:

1. Integer
2. Float
3. Complex

Integer

- Numbers with No Fractional Part
- Can be Positive or Negative
- In Python 3, the int type has no max limit. Values can be as large as the available memory allows.
- Example 100, 0o55 (octal number), 0x68(hexadecimal number)

Float

- Numbers with Fractional Part
- Example 3.14, .314E01

Complex

- Numbers with both real and imaginary components
- A complex number is represented by "x + yj". Example 10 + 9j

Boolean

A boolean data type can assume one of the two possible values : True or False.

Sequence: Sequence is an ordered collection of items or elements which includes several built-in types as String, List, and Tuple. Values in the sequence are called elements/items. Each element in a sequence has a unique index.

String:

- A string is an ordered sequence of characters enclosed in single/double/triple quotes.
- Single Line String : Terminates in a single line. Example - 'This is an example of single line'
- Multi Line String : Does not terminate in a single line. A multiline string may be created using three quotes

List:

- List is an ordered sequence data type which can store values of any data type.
- List is mutable.
- List is enclosed in square brackets []
- Example : [] is an empty List,

[5, 6.5, True, 'Hello'] is a List having 5, 6.5, True and 'Hello' as four elements.

Tuple:

- Tuple is an ordered sequence which can store values of any data type.
- They are immutable, i.e the items of a Tuple cannot be updated after creation.
- Tuple is enclosed in parenthesis ()
- Example : t=() is an empty Tuple

t=(9,) is a Tuple with 9 as an item

t=(8, 5, 9.5, False) is a Tuple with 8, 5, 9.5, False as four items

Mapping

Mapping is an unordered data type in Python. Currently, there is only one standard mapping data type in Python called dictionary.

Dictionary:

- Dictionary in Python stores items in the form of key-value pairs
- Syntax is dict_variable = {key1:value1, key2:value2, ..., key-n:value-n}
- Items in a dictionary are enclosed in curly brackets { } and are separated by commas
- In a key-value pair, the key is separated from the value using a colon (:)
- To access any value in the dictionary, specify the key as the index using square brackets [].
- Example : { } is an empty dictionary,

```
D = {'name':'Python','version':'3.7.2', 'OS': 'Windows'}
```

```
print(D['version']) # shows 3.7.2 as output
```

Special Data-type: None

The None data type/keyword is used to indicate absence of a value (No value or Missing Value).

Example

```
>>> myVar = None
>>> print(type(myVar))
<class 'NoneType'>
>>> print(myVar)
None
```

Operator Precedence(PEMDAS)

PEMDAS stands for Parentheses, Exponents, Multiplication and Division, and Addition and Subtraction. Let's look at each component:

Order	Rule Component	Operators
1st	Parentheses	()
2nd	Exponents	**
3rd	Multiplication and Division	*, /
4th	Addition and Subtraction	+, -

Expression

An expression is combination of operators, operands, literals and parenthesis. An expression produces a value when evaluated.

Evaluation of Expression

1. Evaluate the expression $50 + 20 * 30$

Evaluation:

$= 50 + (20 * 30)$ #precedence of * is more than that of +

$= 50 + 600$

$= 650$

2. Evaluate the expression $100 - 20 + 50$

Evaluation:

The two operators (-) and (+) have equal precedence and the associativity is from left to right so the left operator (i.e. -) will be evaluated first.

$= (100 - 20) + 50$

$= 80 + 50$

$= 130$

3. Evaluate the expression $9 + 3 ** 2 * 4 // 3$

Evaluation:

$= 9 + (3 ** 2) * 4 // 3$

$= 9 + 27 * 4 // 3$ (* and // has left to right associativity)

$= 9 + 108 // 3$

$= 9 + 36$

$= 45$

Type conversion

It is the process of converting the value from one data type into another. Python supports two ways of Type conversion:

- Implicit conversion

- Explicit conversion

Implicit conversion

This type of conversion is performed by Python Interpreter automatically without the user's intervention.

Example:

```
num1 = 20           # num1 is integer
```

```
num2 = 30.5        # num2 is float
```

```
sum1 = num1 + num2 # sum1 will use float to avoid
```

```
                  # loss of fractional part during addition
```

```
print(sum1)
print(type(sum1))
```

Output:

```
50.5
<class 'float'>
```

Explicit Conversion:

This type of conversion is performed by the user manually. It is also known as type-casting. Explicit type-casting is performed using functions such as `int()`, `float()`, `str()` etc.

Syntax : `new_data_type (expression)`

Example

```
num1 = input("Enter a number : ") # takes a string input by default
var1 = int(num1) #converts string to integer
var1 = var1 * 3
print(var)
```

Output

```
Enter a number : 2
6
```

Question 1:

Write the output of the given Python code :

```
a = 0
a += 2
print (a)
a) 2      b) 4      c) 6
```

Question 2:

Write the output of the given Python code :

```
a = 20
if a >= 22:
    print("if")
elif a >= 21:
    print("elif")
else:
    print("else")
a) Else    b) else    c)elif
```

Question 3:

Which Operator is used for comparison of values?

- a) Logical Operators b) Assignment Operators c) Relational Operators

Question 4:

What will be the output of the following code :

```
a = 1
a, b = a+1, a+1
print(a)
print(b)
a) 2,2    b)4,2    c)2,6
```

Question 5:

Use IDLE to calculate : [CBSE Text Book]

(a) $6 + 4 * 10$

(b) $(6 + 4) * 10$

i) (a) 46 b) 100 ii) a) 100 b) 46 iii) a) 100 b) 100

Question 6:

What will be the output of the following code : [CBSE Text Book]

$a = 3 - 4 + 10$

$b = 5 * 6$

$c = 7.0/8.0$

`print(a,b,c, sep=",")`

i) 9,30,0 ii) 9,30,1 iii) 10,30,0

Question 7:

What will be the output of following code?

$X, Y = 2, 6$

$X, Y = Y, X + 2$

`print(X, Y)`

a) 17 5 b) 6 4 c) 4 6

Question 8:

$x = ["apple", "banana"]$

$y = ["apple", "banana"]$

$z = x$

`print(x is z)`

a) True b) False c) True or False

Question 9:

$x = ["apple", "banana"]$

`print("banana" in x)`

a) True b) False c) True or False

Question 10:

What will be the output of following code?

$12 \& 13$

a) 12 b) 13 c) 12 & 13

Question 11:

Which are correct arithmetical operations?

i) $a = 1 * 2$

ii) $2 = 1 + 1$

iii) $5 + 6 = y$

iv) $Seven = 3 * 4$

Question 12:

Which operations result in 8?

i) $65 // 8$

ii) $17 \% 9$

iii) $2 ** 4$

iv) $64 ** 0.5$

Question 13:

If the value of $a = 20$ and $b = 20$, then $a += b$ will assign _____ to a

- a) 40 b) 30 c) 20 d) 10

Question 14:

The _____ operator is used to find out if division of two number yields any remainder

- a) / b) + c) % d) //

Question 15:

Which of the following is the relational operator

- a. //
b. =
c. ==
d. and

Input and Output in Python

Data Input:

input() function is used for getting input from the user. *It returns the input as a String data type by default.*

Explicit type casting is required to convert the input string into any other data type if required.

Data Output:

print() function is used for displaying output on the screen.

Example-1

```
num1 = int(input("Enter a Number : ")) # type casting the input from  
String to Int  
print("The Number is : ", num1)
```

Example-2

```
num = int(input("Enter a Number : "))  
num_cube = num*num*num  
print("The cube is : ",num_cube)
```

Errors

A programmer can make mistakes while writing a program, and hence, the program may not execute or may generate wrong output. The process of identifying and removing such mistakes, also known as bugs or errors, from a program is called debugging.

Errors occurring in programs can be categorised as:

- i) Syntax errors.
- ii) Logical errors
- iii) Runtime errors

Syntax Error

Like other programming languages, Python has its own rules that determine its syntax. The interpreter interprets the statements only if it is syntactically (as per the rules of Python) correct. If any syntax error is present, the interpreter shows error message(s) and stops the execution there. For example, parentheses must be in pairs, so the expression (10 + 12) is syntactically correct, whereas (7 + 11 is not due to absence of right parenthesis. Such errors need to be removed before the execution of the program

Some of the Common Syntax Errors are

- Parenthesis Mismatch
- Misspelled keyword

● Incorrect Indentation

Logical Error

Logical errors occur when the code runs without any errors, but the output is not as expected. Logical errors are caused by a problem in the logic of the code.

Example : `Average = mark_1 + mark_2 / 2` # incorrect calculation of average marks

Corrected Code : `Average = (mark_1 + mark_2) / 2`

Runtime Error

A runtime error causes abnormal termination of the program during the execution. Runtime error occurs when the statement is correct syntactically, but the interpreter cannot execute it.

Runtime errors do not appear until after the program starts running or executing.

Example: 'division by zero'

```
num1 = 5.0
num2 = int(input("num2 = ")) #if the user inputs zero, a runtime error will occur
print(num1/num2)
```

Flow of Control

Flow of Control refers to the order in which statements are executed in a program.

Sequential Flow

The default control flow in a program is sequential flow, in which statements are executed line-by-line one after the other in a sequence in which they are written.

Example

```
x = 6
y = 7
z = y - x
print(z)
```

Conditional Flow

Conditional flow refers to execution of certain statements only if a specific condition is met. This is accomplished by the use of conditional statements such as if, if-else, and if-elif-else.

Example

```
num = int(input("Enter a number : "))
if(num>5):
    print("Number is greater than 5")
else:
    print("Number is less than 5")
```

Output

```
Enter a number : 55
Number is greater than 5
```

Iterative Flow

Iteration means 'repetition'.

Iterative flow repeats statements in a block of code. Repetition or looping can be performed a fixed number of times or until a certain condition is met. This is accomplished through the use of iterative statements: for and while.

Example-1

```
name = input("Enter your name : ")
for x in range(5): # range function creates a sequence of integers from 0 to 4
```

```
print("Hello", name)
```

Example-2

```
name = input("Enter your name : ")  
i=1  
while i<=5:  
    print("Hello", name)  
    i +=1
```

MCQ

- 1.Which one of the following is a valid Python if statement :
a. if a>=2 : b. if (a >= 2) c. if (a => 22) d. if a >= 22
- 2.The order of statement execution in the form of top to bottom is known as construct.
a. alternate b. sequence c. flow of data d. flow chart
- 3.The two membership operators areand
a. in, not in b. true , false c.==,!= d. none
- 4.A graphical representation of an algorithm to solve a problem is called
a. flow of data b. barchart c. flow chart d. none
- 5.What is the logical expression for the following
Either A is greater than B or A is less than C
a. A>B or A<C b. A>B and A<C c . A>Band C d. A>Bor C
- 6.Which statement will check if a is equal to b?
a. if a = b: b. if a == b: c. if a === c: d. if a == b
- 7.Consider the given expression:
"Python" or True and "Programming" or not 70
Which of the following will be correct output if the given expression is evaluated ?
(a) True (b) False (c) 'Python' (d) 'Programming'
- 8.What shape represents a decision in a flowchart ?
(a) A diamond (b) A rectangle (c) An oval (d) A parallelogram
9. To add and assign the value 10 to a variable a we cannot write
(a) a=a+10 (b) a+=10 (c) a=+10 (d) a=10+10

Very Short Answers

Answer the Following Questions (Very Short Answers)

- i. Define Algorithm
- ii. What is decomposition?
- iii. Why do we need Algorithm?
- iv. What is meant by Debugging?
- v. Write difference between algorithm and flowchart.
- vi. Write the pseudocode to print all multiples of 5 between 10 and 25 (including both 10 and 25).
- vii. Write an algorithm to find the greatest among two different numbers
- viii. Write a pseudocode to calculate the factorial of a number
- ix. Write an algorithm to find greatest among three numbers
- x. Is 'None' and None same? Explain Why.

Case based:

Following is an algorithm for going to school or college. Can you suggest improvements in this to include other options?

Reach_School_Algorithm

- a) Wake up
- b) Get ready
- c) Take lunch box
- d) Take bus
- e) Get off the bus
- f) Reach school or college

Short Answers

Answer the Following Questions (Short Answers)

- 1) What is empty statement in Python? What is its need?
- 2) Write a program to check a character is vowel or not
- 3) Explain the data types in python
- 4) Write short notes on types of operators in python with appropriate example
- 5) Write a program to check whether a years is leap year or not.
- 6) What is syntax error? Give one example.
- 7) What is the difference between '=' and '=='? Explain with the help of an example.
- 8) What is the difference between mutable and immutable data types?
- 9) Differentiate between logical and runtime error?
- 10) What is the difference between the following operators?
 - a. * and **
 - b. = and ==
 - c. Logical error and runtime error
 - d. / and //

Long Answers

Answer the Following Questions (Long Answers)

- 1) What is the difference between a keyword and an identifier?
- 2) Classify the different types of decision-making statements.
- 3) Explain briefly constant, variables, expression, keywords and statements available in python.
- 4) What do you understand by precedence of operators? What is the precedence of arithmetic operators?
- 5) What are the three types of flow of control in a program.

STRING

INTRODUCTION

It is a collection of characters (alphabets, digits or special characters including spaces) that is enclosed in single quotes (' ') or double quotes (" ") or triple quotes (" " " ").

Ex- 'Hello Students', "1412" etc.

Strings are immutable, means that the contents of the string cannot be changed after it is created.

INDEXING IN STRING

It is a process in which each character of string has its index or can be accessed using its index. The first character in the string has index 0, the next has index 1, and so on. The index of the last character will be the length of the string minus one (Forward indexing).

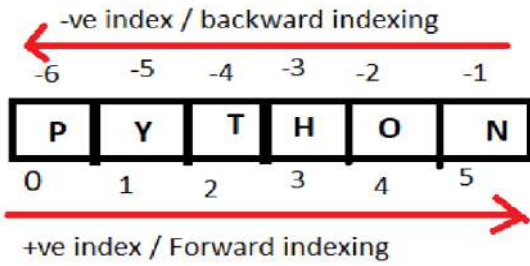

There is another way (Backward indexing) for indexing from last character (index = -1) to first character (index = -length of the string)

STRING OPERATIONS

(1) **Concatenation operator (+)** - The Concatenation operator adds or concat two strings.

```
ex: - >>>Str1= 'Welcome'
      >>>Str2 = ' to KVS'
      >>>print(Str1+Str2)
      'Welcome to KVS'
```

Concatenation operator works for string objects only. If we try another data type with string it will produce error.

```
>>> a=10
>>> b="Hello"
>>> c=a+b
Traceback (most recent call last):
  File "<pyshell#2>", line 1, in <module>
    c=a+b
TypeError: unsupported operand type(s) for +: 'int' and 'str'
>>> a="10"
>>> c=a+b
>>> c
'10Hello'
```

(2) **Replication/repetition operator (*)** - The multiplication operator acts as a replication operator when we have one string and one integer as operands.

```
ex: - >>>print('KVS'*3)
      'KVKVSKVS'
      >>>print('3' *3)
      error
```

(3) **Membership Operators: -**

IN and NOT IN are two membership operators to find the appearance of a substring inside the string.

<p>IN- Returns True if a character or a substring exists in the given string; otherwise, False.</p> <pre>ex: - >>>'N' in 'KVS' False >>>'V' in 'KVS' True</pre>	<p>NOT IN- Returns True if a character or a substring does not exist in the given string; otherwise, False</p> <pre>ex: - >>>'N' not in 'KVS' True >>>'V' not in 'KVS' False</pre>
---	--

(4) **String Slicing:** - Extracting a subpart from a main string is called slicing. It is done by using a range of indices.

Syntax - string_name[Start:Stop:Step]

Note: It will return a string from the index start to stop-1.

<pre>ex: - >>>Str = 'Students' >>>Str[0:8] 'Students' >>>Str[:8] 'Students' >>>Str[0:3] 'Stu'</pre>	<pre>>>>Str[2:5] 'ude' >>>Str[-6:-2] 'uden' >>>Str[4:-1] 'ent' >>>Str[1:8:2] 'tdns'</pre>
---	---

(5) **Traversing:** - Traversing means iterating through the elements of string, one character at a time.

Example	Output
<pre>ex: - >>>Str='Students' >>> for a in Str: print(a,'*', end='')</pre>	<pre>S*t*u*d*e*n*t*s*</pre>
<pre>>>>for a in Str: print(a,'*')</pre>	<pre>S* t* u* d* e* n* t* s*</pre>

BUILT-IN FUNCTIONS/METHODS

Function/Meth hod	syntax	Description
len()	len(str)	Returns the length of the string
count()	str.count(sub, start, end)	It returns number of times substring str occurs in the given string.

split()	str.split(",")	Breaks up a string at the specified separator and returns a list of substrings
capitalize()	str.capitalize()	Converts the first letter of the string in uppercase
title()	str.title()	It returns the string with first letter of every word in the string in uppercase and rest in lowercase.
find()	str.find(sub, start, end)	It is used to search the first occurrence of the substring in the given string.
replace()	str.replace(old, new)	It replaces all the occurrences of the old string with the new string.
index()	index(substr, start, end)	It also searches the first occurrence and returns the lowest index of the substring.
lower()	str.lower()	It converts the string into lowercase
islower()	str.islower()	It returns True if all the letters in the string are in lowercase otherwise false
upper()	str.upper()	It converts the string into uppercase
isupper()	str.isupper()	It returns True if all the letters in the string are in uppercase otherwise false.
isalpha()	str.isalpha()	It checks for alphabets in an inputted string and returns True if string contains only letters else false.
isalnum()	str.isalnum()	It returns True if all the characters are alphanumeric else false.
isdigit()	str.isdigit()	It returns True if the string contains only digits, otherwise false.
lstrip()	str.lstrip(chars) str.lstrip()	It returns the string after removing the space from the left of the string
rstrip()	str.rstrip(chars) str.rstrip()	It returns the string after removing the space from the right of the string
strip()	str.strip()	It returns the string after removing the space from the both side of the string
index()	str.index(substring)	It returns the index position of an element or an item in a string of characters or a list of items.
startswith()	string.startswith(substring, start, end)	It returns True if the string starts with the given substring, and False otherwise.

<code>partition()</code>	<code>str.partition(separator)</code>	It splits a given string into three parts based on the first occurrence of a specified separator. It returns a tuple containing the three parts: the portion before the separator, the separator itself, and the portion after the separator.
<code>join()</code>	<code>separator.join(iterable)</code>	It is used to concatenate elements from an iterable (like a list or tuple) into a single string, with a specified separator between each element.
<code>endswith()</code>	<code>string.endswith(substring, start, end)</code>	It returns True if the string ends with the given substring, and False otherwise.

MIND MAP OF STRING

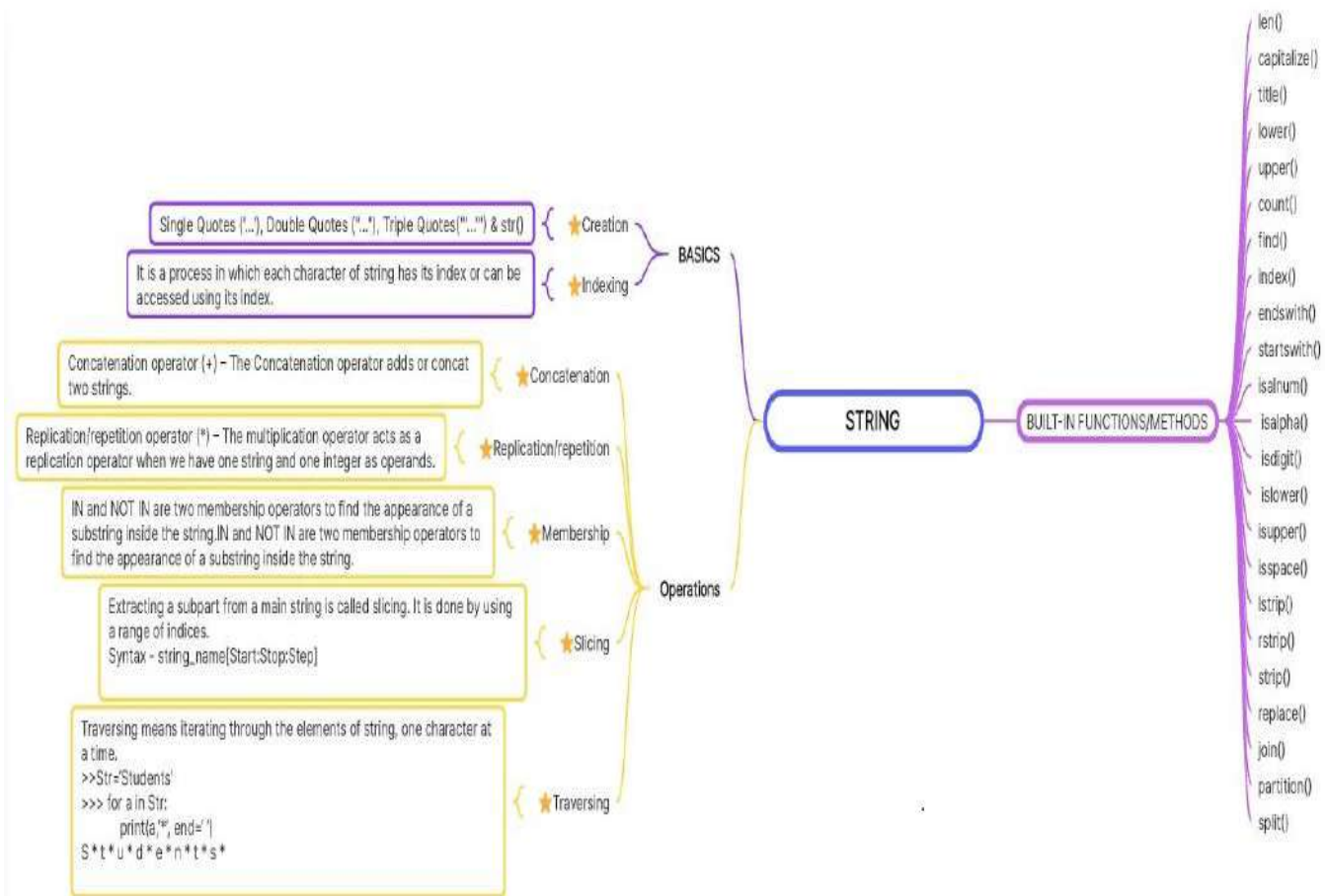

Multiple Choice Question

- Q.1 What is the output of the following code?
 example = "snow world"
 example[3] = 's'
 print (example)
 (a) snow (b) snow world (c) Error (d) snos world
- Q.2 Which of the following statement will return the last three characters of a string 'str'?
 (a) str[3:] (b) str[:3] (c) str[-3:] (d) str[: -3]
- Q.3 Find the operator which cannot be used with a string in Python from the following:
 (a) + (b) not in (c) * (d) //
- Q.4 Which of the following operations on a string will generate an error?
 (a) "PYTHON"*3 (b) "PYTHON" + "20" (c) "PYTHON" + 10 (d) "PYTHON" + "LANGUAGE"
- Q.5 Which of the following is not a valid string in Python?
 (a) "Hello" (b) 'Hello' (c) "Hello' (d) None of the above
- Q.6 Which of the following operators is used for concatenation of two strings?
 (a) - (b) * (c) + (d) /
- Q.7 Which of the following functions will return the total number of characters in a string?
 (a) count() (b) index() (c) len() (d) all of these
- Q.8 Which of the following function is used for checking whether a string is containing digits only:
 (a) isalpha() (b) isdigit() (c) isalnum() (d) None of the above

Q.9 What will be the output of above Python code?

```
str1= "6/4"  
print("str1")
```

(a) 1 (b) 6/4 (c) str1 (d) 1.5

Q.10 Which of the following will result in an error?

```
str1="python"
```

(a) print(str1[2]) (b) str1[1]="x" (c) print(str1[0:9]) (d) None of these

Competency Based Question

Q.1 What will be the output of the following code

```
Msg="CompuTer"  
Msg1=""  
for i in range(0, len(Msg)):  
    if Msg[i].isupper():  
        Msg1=Msg1+Msg[i].lower()  
    elif i%2==0:  
        Msg1=Msg1+'*'  
    else:  
        Msg1=Msg1+Msg[i].upper()  
print(Msg1)
```

Ans. cO*P*t*R

Q.2 What is the output of the following?

```
print('abcdefcdghcd'.split('cd'))
```

Ans. ['ab', 'ef', 'gh', '']

Q.3 What is the output of the following?

```
print('ab cd ef'.title())
```

Ans. Ab Cd Ef

Q.4 Suppose s is "\t\tWorld\n", what is s.strip() ?

Ans. World

Q.5 Write a program to input a string and calculate the length of the string without using len().

Q.6 Write a program to input a string and print the total number of uppercase and lowercase letters in a given string.

Q.7 Find the output

```
str="KVS RO Delhi"  
for i in str:  
    if(i.isupper()==True):  
        print(i.lower(),end="")  
    if(i.islower()==True):
```

```
print(i.upper(), end="")
```

Ans. kvsrodELHI

Q.8 What is the output of the following?

```
print('ab12'.isalnum())
```

Ans. True

Q.9 Find the output:

```
str="PYTHON@LANGUAGE"  
print(str[2:12:2])
```

Ans. TO@AG

Q.10 Find and write the output of the following python code:

```
x = "abcdef"  
i = "a"  
while i in x:  
    print(i, end = " ")
```

Ans. aaaaaa ---- OR infinite loop

Very short Questions

Q.1 What is a string in Python?

Ans. It is a collection of characters enclosed in ' ' or " " or "" "" .

Q.2 Write python code to print the string "KVS" 5 times.

Ans. >>>"KVS"*5

Q.3 What is the index value of first character of string in Python?

Ans. 0

Q.4 If A = "Hello" then what will be the value of A[3] ?

Ans. 'l'

Q.5 Is 555 or '555' same ?

Ans. No

Q.6 Identify valid string literals : 'marks', '123', "L@", "mark'.

Ans. '123', "L@"

Q.7 How many times is the word "Hi" displayed in the following statement?

```
s='python world'  
for ch in s[3:8]:  
    print('Hi')
```

Ans. 5 times

Q.8 Suppose word = 'amazing', then what will be word[: :-2]?

Ans. 'giaa'

Q.9 Out of the following operators, which one's cannot be used with strings?

=, -, *, /, //, %, >, <>, in, not in, <=

Ans. /, // and %

Q.10 If s= 'Middleeast', then what will be the output of s[5:-2].

Ans. 'eea'

Short Questions

Q.1 Write a python code to give this output :

H # E # L # L # 0 #	Ans. s='HELLO' for x in s: print(x,'#')
---------------------------------	---

Q.2 What is a string slice? How is it useful?

Ans. String Slice is a part of a string containing some contiguous characters from the string. It is accessed from the string by providing a range in “[]” brackets i.e. S1[n:m]. Python returns all the characters at indices n, n+1, n+2. . n-1 e.g. S= "Barabanki" S[4:7]will return 'ban'.

Q.3 WAP to print the following pattern without using any nested loop.

# # # # # # # # # # # # # # #	Ans. N=5 for I in range(1,N+1): print("#"*I)
---	--

Q.4 Which functions would you chose to use to remove leading and trailing white spaces from a given string?

Ans. Python String strip() function will remove leading and trailing white spaces. If you want to remove only leading or trailing spaces, use lstrip() or rstrip() function instead.

Q.5 Find the value stored in C at the end of this code snippet:

```
str="Darjeeling Tea has a strong flavour"  
C=0  
for i in str:  
    if i in 'aeiouAEIOU':  
        C += 1
```

```
print(C)
```

Ans. 12

Q.6 (A) Assertion: str1="Hello" and str2="World" then print(str1*3) will give error
(R) Reason : * replicates the string hence correct output will be HelloHelloHello

Ans. A is false and R is correct.

Q.7 Using string replication techniques print the following pattern using any loop.
Hello

Hello Hello

Hello Hello Hello

Ans. `for a in range(1,4):
 print("hello " * a)`

Q.8 What is the difference between `partition()` and `split()` function in Python ?

Ans. `partition()` – it partitions the string on the first occurrence of substring.

ex:- `s='hello all'`

`s.partition('a') => ('hello ', 'a', 'll')`

`s.partition('all') => ('hello ', 'all', '')`

`split()` – it returns a list of strings as splitted. ex:- `s='hello all'`

`s.split() => ['hello', 'all']`

Q.9 What is the concatenation operator in Python ?

Ans. Concatenation operator (`+`) –The concatenation operator adds or concat two strings. ex:-

`s1='Welcome'`

`s2 = 'All'`

`print(s1+s2)`

=>Output :- WelcomeAll

Q.10 Write a program to change a given string to a new string exchanging first and last character

Ans. `s=input("Enter any string")`

`ns = s[-1:] + s[1:-1] + s[:1]`

`print ("New String- ",ns)`

Long Question

Q.1 Write a program to calculate digits and letters in a string.

Ans `string=input("Enter string:")`

`count1=0`

`count2=0`

`for i in string:`

`if(i.isdigit()):`

`count1=count1+1`

`elif(i.isalpha()):`

`count2=count2+1`

`print("The number of digits is:",count1)`

`print("The number of characters is:",count2)`

Q.2 Write a program to count a specific character in a string.

Ans. `string=input("Enter string:")`

`count=0`

`ch=input("Enter character you want to count-- ")`

`count=string.count(ch)`

`print("The count of ",ch,"in string is ",count)`

Q.3 Consider the following string country:

`country= "Great India"`

What will be the output of the following string operations(Any Four):-

<pre>(a) print(country[0:len(country)]) (b) print(country[-7:-1]) (c) print(country[::2]) (d) print(country[len(country)-1]) (e) print(2*country) (f) print(country[:3] + country[3:])</pre>	<pre>Ans. (a)Great India (b)t Indi (c)GetIda (d)a (e)Great IndiaGreat India (f)Great India</pre>
--	--

Q.4 Find Output:

<pre>my_string = 'Jhunjhunu' print(my_string[:3]) for i in range(len(my_string)): print(my_string[i].upper(),end="@") print() print (my_string) print (my_string[3:6])</pre>	<pre>Ans. Jhu J@H@U@N@J@H@U@N@U@ Jhunjhunu Njh</pre>
--	--

Q.5 Write a Python Program to input a string to check whether it is a Palindrome string or not. (A Palindrome string is that which is same from both ends like – NITIN, MALAYALAM, PULLUP)

```
Ans. s=input("Enter a word :")
     print ("You entered :", s)
     length=len(s)
     rev=""
     for i in range (-1,-length-1,-1):
         rev=rev+s[i]
     if s==rev:
         print ("Yes, palindrome")
     else:
         print ("Not a palindrome")
```

Case Study based question

Q.1 Ravee is developing a program to greet users based on their input. It takes a name as input and returns a greeting message in the format "Hello, [name]!".

```
Ans. user_name = input("Enter your name: ")
     print("Hello",user_name,"!")
```

Q.2 Gorank is tasked with processing a file name and extracting the file extension. Program takes a file name as input and return the output of its extension.

```
Ans. file_name = input("enter the file name with extension: ")
     if '.' in file_name:
         print("The file extension of", file_name, "is", file_name.split('.')[1])
     else:
         print("No extension found")
```

LIST

INTRODUCTION

Lists are used to store multiple items in a single variable. Lists are enclosed in square brackets and the elements of the list are separated by commas. List is a mutable data type, means that the contents of the list can be changed after it is created.

ex: - L = [12, 23, 'A', "45"]

L1 = [] # L1 is a blank list

L2 = list() # list() function is used to create list L2

L3 = [1,2,3,4,5] # L3 is an integer list

L4 = ["ABC", 15, False, 25.5, "male"] # L4 is a list with mix data types

L5 = ['a', [2,4,'b'], 56] # L5 is a nested list

INDEXING IN LIST

It is a process in which each element of a list has its index or can be accessed using its index. The first element of the list has index 0, the next has index 1, and so on. The index of the last element will be the length of the minus one (Forward indexing).

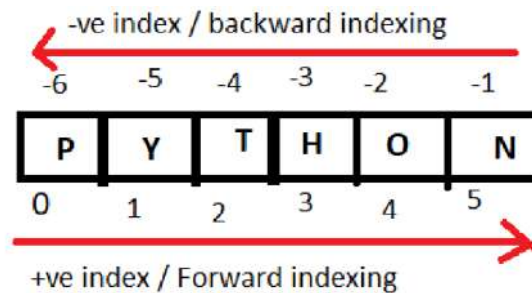

There is another way (Backward indexing) for indexing from last element (index = -1) to first element (index = -length of the list)

LIST OPERATIONS

(1) Concatenation (+ Operator): Python allows us to join two or more lists using + operator.

```
ex: - >>> l1 = [1,3,5,7,9]
      >>> l2 = [2,4,6,8,10]
      >>> l3 = ['abc', "qwe"]
      >>>l1 + l2 + l3      # + operator
      [1,3,5,7,9,2,4,6,8,10, 'abc', "qwe"]
```

(2) Repetition/ Replication Operator (* operator): Python allows us to replicate a list using repetition operator depicted by symbol '*'.
ex: - >>> str1 = ['Help']
>>> str1 * 4
[' Help ', ' Help ', ' Help', " Help"]

(3) Membership (IN/ NOT IN operator) :

Like strings, the membership operators IN checks, if the element is present in the list then returns True,	NOT IN operator returns True if the element is not present in the list, else it
--	---

<p>else returns False.</p> <p>ex: - >>>'N' in ['K', 'V', 'S']</p> <p style="padding-left: 40px;">False</p> <p style="padding-left: 40px;">>>>'V' in ['K', 'V', 'S']</p> <p style="padding-left: 40px;">True</p>	<p>returns False.</p> <p>ex: - >>>'N' not in ['K', 'V', 'S']</p> <p style="padding-left: 40px;">True</p> <p style="padding-left: 40px;">>>>'V' not in ['K', 'V', 'S']</p> <p style="padding-left: 40px;">False</p>
---	--

List Slicing: - Like strings, the slicing operation can also be applied to lists. List elements can be accessed in subparts.

Syntax- list_name[start:stop:step]

L = [2,7,9,10,13,15,17,19,23,25]

Slice

- L[4:]
- L[:3]
- L[2:5]
- L[4:2]
- L[2:7:2]
- L[:: -1]
- L[:: -2]
- L[6:1: -2]
- L[-8:8]
- L[3: -2: 2]
- L[6: -9: -2]

Generates

- [13, 15, 17, 19, 23, 25]
- [2,7,9]
- [9,10, 13]
- [13, 17, 23]
- [9, 13, 17]
- [25, 23, 19, 17, 15, 13, 10, 9, 7, 2]
- [25, 19, 15, 10, 7]
- [17, 13, 9]
- [9, 10, 13, 15, 17, 19]
- [10, 15, 19]
- [17, 13, 9]

(4) Traversing: - Traversing means iterating through the elements of a list, one element at a time.

<p>ex: - >>>L1 = [1,2,3,4]</p> <p style="padding-left: 40px;">>>>for a in L1:</p> <p style="padding-left: 80px;">print(a)</p>	<p>1</p> <p>2</p> <p>3</p> <p>4</p>
---	-------------------------------------

(5) Modifying a List element/Mutability of a List: - The elements of a list can be modified by using L[index]=new_value. Since a list can be modified in place, i.e. the existing list object is not destroyed and recreated.

<p>ex: - >>>L = [1,2,3,4,5]</p> <p style="padding-left: 40px;">>>>L[2] = 11</p> <p style="padding-left: 40px;">>>>L[-1] = 22</p> <p style="padding-left: 40px;">>>>print (L)</p>	<p>[1,2,11,4,22]</p>
--	----------------------

(6) List Comparisons: - The relational operators >, >=, <, <=, ==, != can be applied for comparison between two lists results will come in True or False. The following rules are observed:

- (a) For equality (==) operator: - Equality evaluates to True only when all the elements of one list match all the elements of the other list and both the list have the same number of elements.
- (b) For all other operators - The elements are compared sequentially using the operator under consideration.
- (c) If two lists are of different lengths and if one of the list has an element at an index position and the other list does not have an element at that position then the evaluation proceeds as follows:

- something/somevalue > empty/nothing evaluates to True
- something/somevalue < empty/nothing evaluates to False

<pre>ex: - >>>print([1,2,3] == [1,2,3]) True >>>print([1,2,3] != [1,2,3]) False >>>print([1,2,8,9] < [9,1]) True</pre>	<pre>>>>print([1,2,8,9] >= [1,9]) False >>>print([1,2] < [1,2,3]) True >>>print([2] > [1,2,3]) True</pre>
--	---

List Functions :-

Function	Syntax	Description
list()	list(sequence)	It returns a list created from the passed arguments, which should be a sequence type (string, list, tuple etc.). if no argument is passed, it will create an empty list.
append()	list.append(items)	It adds a single item to the end of the list.
extend()	list1.extend(list2)	It adds one list at the end of another list.
insert()	list.insert(index_no, value)	It adds an element at a specified index
reverse()	list.reverse()	It reverses the order of the elements in a list.
index()	list.index(item)	It returns the index of first matched item from the list.
len()	len(list)	Returns the length of the list i.e. number of elements in a list
sort()	list.sort()	This function sorts the items of the list.
clear()	list.clear()	It removes all the elements from the list.
count()	list.count(element)	It counts how many times an element has occurred in a list and returns it.
sorted()	sorted(sequence,reverse=False)	It returns a newly created sorted list; it does not change in the original list.
pop()	list.pop(index)	It removes the element from the specified index and also returns the element which was removed.
remove()	list.remove(value)	It is used when we know the element to be deleted, not the index of the element.

max()	max(list)	Returns the element with the maximum value from the list.
min()	min(list)	Returns the element with the minimum value from the list
sum()	sum(list)	It returns the sum of elements of the list.
max()	max(list)	Returns the element with the maximum value from the list.
min()	min(list)	Returns the element with the minimum value from the list
sum()	sum(list)	It returns the sum of elements of the list.

MIND MAP OF LIST

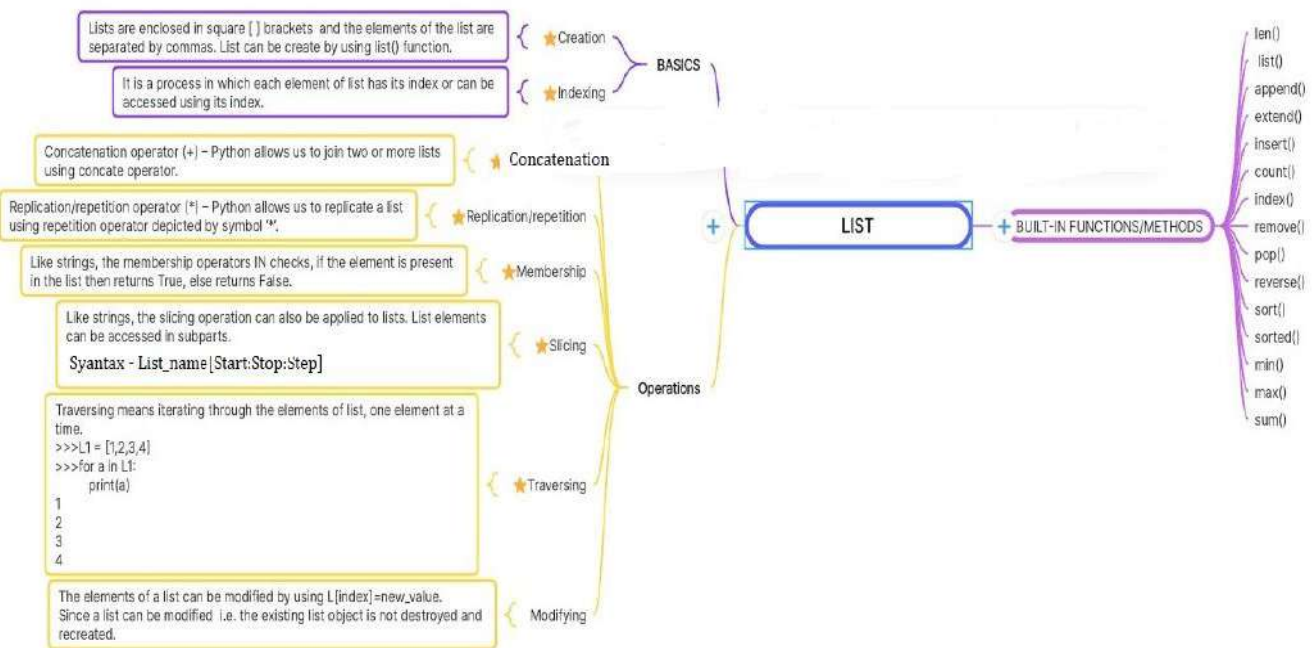

Multiple Choice Question

- Q.1 The data type list is an ordered sequence which is made up of one or more elements.
 (a) Mutable (b) Immutable (c) Both a and b (d) None of the above
- Q.2 Which statement from the list below will create a new list?
 (a) new_l = [1, 2, 3, 4] (b) new_l = list() (c) Both a and b (d) None of the above
- Q.3 What will be the output of the following python code
 new_list = ['P','y','t','h','o','n']
 print(len(new_list))
 (a) 6 (b) 7 (c) 8 (d) 9
- Q.4 We can access each element of the list or traverse a list using.
 (a) for loop (b) while loop (c) Both a and b (d) None of the above
- Q.5 What will be the output of the following python code?
 new_list = "1234"
 print(list(new_list))
 (a) ['1', '2', '3', '4'] (b) ('1', '2', '3', '4') (c) {'1', '2', '3', '4'} (d) None of the above
- Q.6 Suppose list1 is [2, 33, 222, 14, 25], What is list1[-1] ?
 (a) Error (b) None (c) 25 (d) 2

- Q.7 Suppose list1 is [1, 3, 2], What is list1 * 2 ?
 (a) [2, 6, 4] (b) [1, 3, 2, 1, 3] (c) [1, 3, 2, 1, 3, 2] (d) [1, 3, 2, 3, 2, 1]
- Q.8 Write the output of the following code :
 list("welcome")
 (A) ['w', 'e', 'l', 'c', 'o', 'm', 'e'] (B) ('w', 'e', 'l', 'c', 'o', 'm', 'e') (C) ['welcome'] (D) None
- Q.9 Write the output of the following code :
 L=list("abcdefgh")
 print(L[4 : -2])
 (a) ['e', 'f'] (b) ['d', 'e', 'f'] (c) (def) (d) Error
- Q.10 Write the output of the following code :
 >>>L=[1,2,3,4,5,[6,7,8]]
 >>>print(L[5])
 (a) [6, 7, 8] (b) 6, 7, 8 (c) Error (d) 6

ANSWERS OF MCQ

(1) a, (2) c, (3) a, (4) c, (5) a, (6) c, (7) c, (8) a, (9) a, (10) a

Competency Based Question

- Q.1 Differentiate between append () and extend ()
- Q.2 Differentiate between List and string.
- Q.3 Write a program to increment the elements of a list with a number?
- Q.4 WAP to calculate the mean of the given list of numbers.
- Q.5 Write a program to print list having numbers less than 20.
- Q.6 What will be the output of the following program?
 l=[6,12,18,24,30]
 for i in l:
 for j in range(1,i%4):
 print(j,'#',end="")
 print()
- Q.7 Write a program that reverses a list of integers.
- Q.8 Write a program to find the number of times an element occurs in the list.
- Q.9 Write a program to find the largest and smallest number in a list.
- Q.10 Write a program to check if a number is present in the list or not. If the number is present, print the position of the number. Print an appropriate message if the number is not present in the list.

Very short Questions

- Q.1 Suppose a list is L=[2, 33, "KVS", 14, 25], what is L[-3]?
 Ans. "KVS"
- Q.2 Given a list L=[1, 2, ["COMPUTER", "SCIENCE"], "IS", "TUPLE"]
 What will be the value of L[- 3][1].
 Ans. "SCIENCE"
- Q.3 A = [] and A = list() will produce the same result.
 Ans True
- Q.4 Lists once created cannot be changed.
 Ans. False

Q.5 To sort a list, sort() and sorted(), both can be used.

Ans. True

Q.6 Write the difference between list pop() method and remove() method.

Q.7 What do you understand by mutability?

Q.8 What are nested lists?

Ans. A list can have an element in it, which itself is a list. Such a list is called nested list.e.g.

```
L=[1,2,3,4,[5,6,7],8]
```

Q.9 myList = [1,2,3,4,5,6,7,8,9,10]

```
del myList[3:]
```

```
print(myList)
```

Ans. [1,2,3]

Q.10 Find out the errors and write the correct code :

```
a=[5, 6, 3, 4, 1]
```

```
b=a* "3"
```

```
c=a+b
```

Ans. b=a*3

Short Questions

Q.1 What will be the output of the following code?

```
L=[3, 5, 1, 10, 2]
```

```
L.append(55)
```

```
print(L)
```

Ans. [3, 5, 1, 10, 2, 55]

Q.2 What is the output of the following code?

```
a={1:"A",2:"B",3:"C"}
```

```
for i,j in a.items():
```

```
    print(i,j,end=" ")
```

Q.3 How is the pop() function different from remove() function working with lists in python ? Explain with examples.

<pre>Ans. pop() function removes the last value and returns the same. >>>l=[10,20,30,20] >>>l.pop() 20</pre>	<pre>The remove() method removes the first matching value from the list. >>>l.remove(20)</pre>
--	---

Q.4 What is the output when the following code is executed ?

```
>>>names = ['Amir', 'Bear', 'Charlton', 'Daman']
```

```
>>>print(names[-1][-1])
```

Ans. n

Q.5 Compare lists with strings. How are they similar and how are they different?

Ans. The similarity between Lists and Strings in Python is that both are sequences. The differences between them are that firstly, Lists are mutable but Strings are immutable. Secondly, elements of a list can be of different types whereas a String only contains characters that are all of String type.

Q.6 Write a program to accept a list of numbers and find the sum of all the numbers in the list.

Q.7 WAP to search for an element in a given list of numbers.

Q.8 WAP to find the minimum element from a list of elements along with its index in the list.

Q.9 What will be the output of the following program:

```
l=[10,20,30,40,50,60]
for i in range(len(l)):
    if(i%2==0):
        print(l[i],end='#')
    else:
        print(l[i],end='@')
```

Q.10 What will be the output of following program:

```
odd = [1, 9]
odd.insert(1,3)
print(odd)
odd[2:2] = [5, 7]
print(odd)
```

Long Question

Q.1 Write a program that takes any two lists L and M of the same size and adds their elements together to form a new list N whose elements are sums of the corresponding elements in L and M. For instance, if L = [3, 1, 4] and M = [1, 5, 9], then N should equal [4,6,13].

Q.2 Write a Python program to input 10 numbers to store in the list and print the third largest number. For example, if the entered numbers in the list are List are 36, 25, 14, - 951, 75, - 85, 654, 88, 9521, 657, then output will be The third largest number is : 654

Q.3 Take a list of 10 elements. Split it into middle and store the elements in two different lists.

E.g.- INITIAL list : 5 10 6 12 3 25 66 44 1 90

After splitting : 5 10 6 12 3

25 66 44 1 90

Q.4 Find and write the output of the following Python code :

<pre>x= [1, 2, [3, "KVS", 4], "KV"] print(x[0]) print(x[2]) print(x[-1]) print(x[0:1]) print(2 in x)</pre>	<p>Ans.</p> <p>1</p> <p>[3, 'KVS', 4]</p> <p>KV</p> <p>[1]</p> <p>True</p>
--	--

<pre>print(x[0]==8) print(len(x)) x.extend([12,32,4]) print(len(x))</pre>	<pre>False 4 7</pre>
---	----------------------

Q.5 Consider the following list L=[13,18,20,10,18,23] Write python statements to perform

- (a) Count number of times the value 18 is repeating
- (b) Arrange values in descending order
- (c) Remove the last element
- (d) Insert 15 at index position 3

Q.6 Guddu is building a program to process student average marks. It takes marks of five subjects and calculates the average marks.

Ans.

```
student_marks = eval(input(" Enter marks of five subject in a list (Max. is 100): "))
total_marks=sum(student_marks)
avg_marks= total_marks/5
print("Average marks is: ", avg_marks)
```

TUPLE

INTRODUCTION

A tuple is a collection which is ordered and immutable (We cannot change elements of a tuple in place). Elements of a tuple are enclosed in parenthesis (round brackets) and are separated by commas. Tuples can store a sequence of values belonging to any type. Tuples allows duplicate members.

```
Ex:-  T1 = ()                # Empty Tuple
      T2 = (4,5,6)          # Tuple of integers
      T3 = (1.5,4,9)        # Tuple of numbers
      T4 = ('x', 'y', 'z')  # Tuple of characters
      T5 = ('a',1.5,'KVS',45) # Tuple of mixed values
      T6 = ('KVS', 'NVS', 'EMRS') # Tuple of strings
      >>>t2 = (10,)         # Single element tuple
```

Note:- comma is necessary in single value tuples. Without a comma it will be a value, not a tuple.

```
>>>t3=(10,20,30,40,50)  # Long tuple
>>>t4=(6,(4,5),9,7)     # Nested Tuple
```

- tuple() function is used to create a tuple from other sequences.
- Indexing of tuple is similar to indexing of list.
- Difference between List and Tuple

S. No.	List	Tuple
01	Elements are enclosed in square brackets i.e. []	Elements are enclosed in parenthesis i.e. ()
02	It is mutable data type	It is immutable data type
03	Iterating through a list is slower as compared to tuple	Iterating through a tuple is faster as compared to list

TRAVERSING A TUPLE

Traversing a tuple means accessing and processing each element of it. A tuple can be traversed using a loop.

```
Ex:-  >>> T1=(2,4,6,8,10)          Output:      2
      >>> for a in T1:              4
      print(a)                     6
                                    8
                                    10
```

ACCESSING TUPLES

Elements of a tuple can be accessed using Indexing and Slicing, same as in string and list. if T1= ('C', 'O', 'M', 'P', 'U', 'T', 'E', 'R'):

Elements	C	0	M	P	U	T	E	R
+ index Value	0	1	2	3	4	5	6	7
- Index Value	-8	-7	-6	-5	-4	-3	-2	-1

```
>>> T1[2] #WILL ACCESS 'M'
>>> T1[-3] #WILL ACCESS 'T'
>>> T1[1:7:1] #WILL ACCESS 'OMPUTE'
```

OPERATORS IN TUPLE

Operation Name	Description	Example
Concatenation (+)	Joining of two or more tuples is called concatenation Python allows us to join tuples using concatenation operator (+)	<pre>>>>t1 = (1, 2, 3) >>>t2 = (8, 9, 11) >>>t1+t2 OUTPUT : (1, 2, 3, 8, 9, 11) (#concatenates two tuples) >>>t1 = (1, 2, 3) >>>t2 = (8, 9, 11) >>>t3 = t1+t2 (#Created new tuple) OUTPUT : (1, 2, 3, 8, 9, 11) Concatenation operator can also be used for extending an existing tuple. >>>t1 = (1, 2, 3) >>>t1 = t1 + (7,8,9) >>>t1</pre>
Repetition (*)	It is used to repeat elements of a tuple. Repetition operation is denoted by Symbol (*)	<pre>>>>h1 = ('H', 'M') >>>h1 * 3 ('H', 'M', 'H', 'M', 'H', 'M')</pre>
Membership	The 'in' operator checks the presence of element in tuple. If the element is present it returns True, else it returns False.	<pre>>>>h1 = ('H', 'M') >>>'H' in h1 True >>>'m' not in h1</pre>

	The not in operator returns True if the element is not present in the tuple, else it returns False.	True
Slicing	It is used to extract one or more elements from the tuple. Like string and list, slicing can be applied to tuples also.	<pre>>>>t1 = (1, 2, 3, 7, 8, 9) >>>t1[2:4] (3, 7) >>>t1 =(10, 20, 30, 40, 50, 60, 70, 80) >>>t1[2 : 7] (30, 40, 50, 60, 70) >>>t1[: 5] (10, 20, 30, 40, 50) >>>t1[: : -1] (80, 70, 60, 50, 40, 30, 20, 10)</pre>

Tuple Methods and Built-in Functions

Method Name	Description	Example
len()	This method returns the length of tuple or the number of elements in the tuple.	<pre>>>>t1 =(10,20,30,40,50, 60, 70, 80) >>>len(t1) 8</pre>
tuple()	This function creates an empty tuple or creates a tuple if a sequence is passed as argument.	<pre>>>>t1 = tuple() >>>type(t1) <class 'tuple'> >>>t1 = tuple('python') #string >>>t1 ('p', 'y', 't', 'h', 'o', 'n') >>>t1 = tuple([1,2,3]) #list >>>t2 (1, 2, 3)</pre>

		<pre>>>>t1 = tuple(range(7)) >>>t1 (0, 1, 2, 3, 4, 5, 6)</pre>
count()	This function returns the frequency of an element in the tuple.	<pre>>>>t1=tuple("tuples in python") >>>t1.count('p') 2</pre>
index()	This function returns the index of the first occurrence of the element in the given tuple.	<pre>>>>t1=tuple("tuples in python") >>>t1.index('n') 8 >>>t1=tuple("tuples in python") >>>t1.index('f') ValueError: tuple.index(x): x not in tuple</pre>
sorted()	This element takes tuple as an argument and returns a sorted list. This function does not make any change in the original tuple.	<pre>>>>t1 = ('t', 'u', 'p', 'l', 'e', 's') >>>sorted(t1) ['e', 'l', 'p', 's', 't', 'u'] >>>t1 ('t', 'u', 'p', 'l', 'e', 's')</pre>
min()	This function returns the minimum or smallest element of the tuple.	<pre>>>>t1 = (3, 8, 4, 10, 1) >>>min(t1) 1 >>>t1 = ('t', 'u', 'p', 'l', 'e', 's') >>>min(t1) 'e'</pre>
max()	This function returns the maximum or largest element of the tuple.	<pre>>>>t1 = (3, 8, 4, 10, 1) >>>max(t1) 10 >>>t1 = ('t', 'u', 'p', 'l', 'e', 's') >>>max(t1) 'u'</pre>
sum()	This function returns the sum of the elements of the tuple.	<pre>>>>t1 = (3, 8, 4, 10, 1) >>>sum(t1) 26</pre>

MIND MAP OF TUPLE

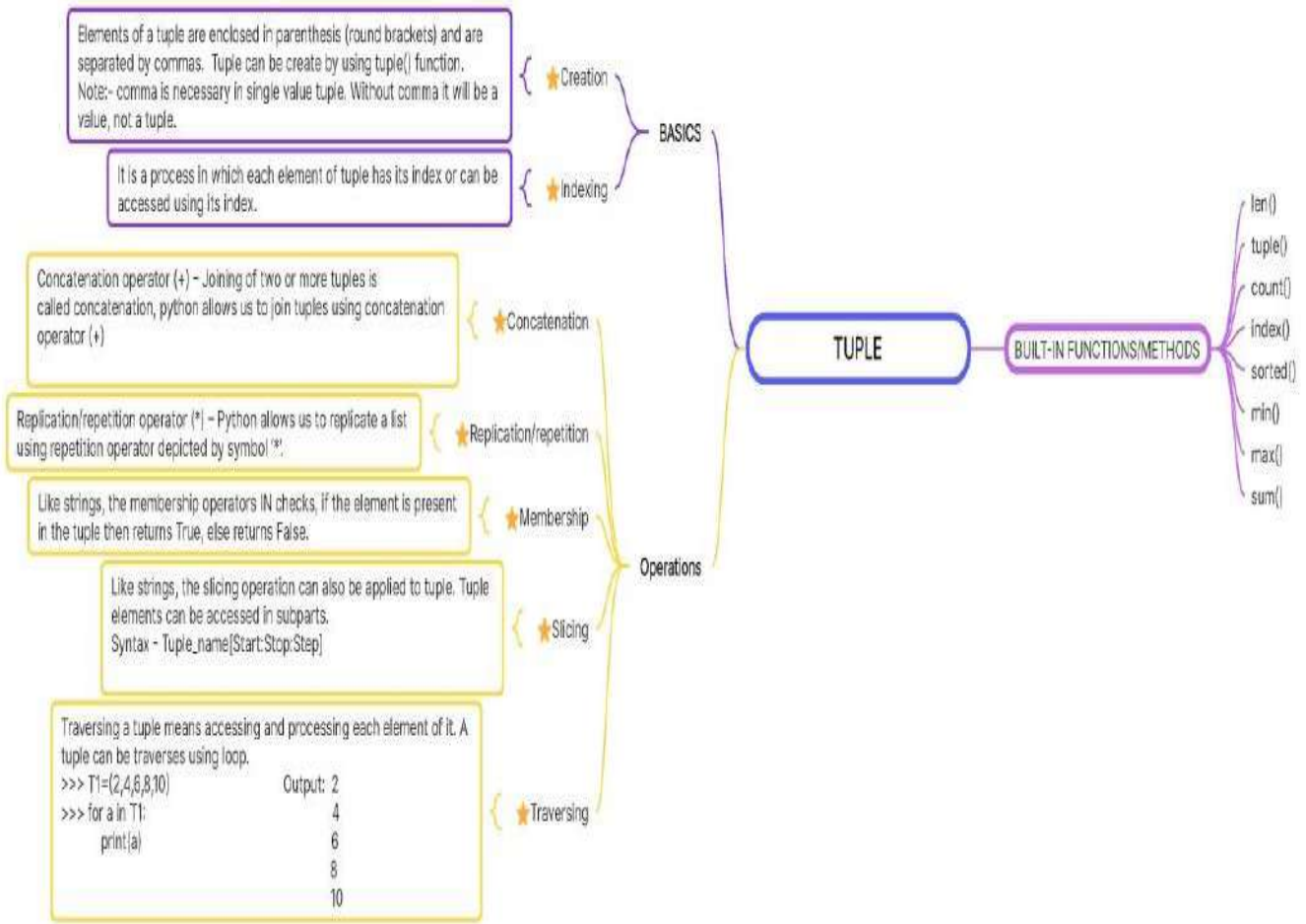

Multiple Choice Question

- Q.1 What type of error is returned by following code :
- ```
a=("Amit", "Sumit", "Ashish", "Sumanta")
print(a.index("Suman"))
```
- (a) Syntax Error      (b) Value Error      (c) Type Error      (d) Name Error
- Q.2 What is the length of the given tuple? `>>> t1=(1,2,(3,4,5))`
- (a) 1      (b) 2      (c) 3      (d) 4
- Q.3 Which of the following statements will return an error. T1 is a tuple.
- (a) `T1 + (23)`      (b) `T1 + [3]`      (c) Both (a) & (b)      (d) None
- Q.4 What is the output of following code?
- ```
>>> t1=(1,2,(3,4,5,2))
>>> print(len(t1[2]))
```
- (a) 1 (b) 2 (c) 3 (d) 4
- Q.5 Which of the following is not a tuple?
- (a) `P = 1,2,3,4,5` (b) `Q = ('a', 'b', 'c')` (c) `R = (1, 2, 3, 4)` (d) None
- Q.6 Which of the following is/are features of tuple?
- (a) Tuple is immutable (b) Tuple is a sequence data type.
 (c) In tuple, elements are enclosed in Parenthesis (d) All of the above
- Q.7 Which of the following is not a function of tuple?
- (a) `update()` (b) `min()` (c) `max()` (d) `count()`

- Q.8 Which of the following is/are features of tuple?
 (a) Tuple is immutable (b) Tuple is a sequence data type.
 (c) In tuples, elements are enclosed in Parenthesis. (d) All of the above
- Q.9 Which of the following is a tuple with a single element?
 (a) t = (1,) (b) t = 1, (c) Both (a) & (b) (d). None of the above
- Q.10 Rahul wants to delete all the elements from the tuple t, which statement he should use
 (a) del t (b)clear() (iii) t.remove() (iv) None of these

ANSWERS OF MCQ

(1) b, (2) c, (3) c, (4) c, (5) a, (6) d, (7) a, (8) d, (9) c, (10) a

Competency Based Question

Q.1 Discuss the utility and significance of Tuples, briefly.

Ans. It is a type of array. It plays a very important role in python. In python it is an immutable type of container which stores any kind of data types. It is short in memory size in comparison to lists.

Q.2 Lists and Tuples are ordered. Explain.

Ans. Lists and Tuples are ordered sequences as each element has a fixed position.

Q.3 Write the output of the following.

```
a=(23,34,65,20,5)
print(a[0]+a.index(5))
```

Ans. 27

Q.4 Create a tuple names as given here:

names = ('JAI', 'RAM', 'MAMTA', 'KAPIL', 'DINESH', 'ROHIT') Write proper code for getting:
 ('MAMTA', 'KAPIL', 'DINESH')

Ans. print(names [2 : 5])

Q.5 T1=(1,2) & T2=("KV",)
 print(T2*2)

Ans. ('KV','KV')

Q.6 T1=(45,67,98)
 T1=T1+(1,2,3)
 print(T1)

Ans. (45,67,98,1,2,3)

Q.7 Consider the following tuple and write the code in python for the following statements:

```
T1=(12,3,45,'Hockey','Anil',('a','b'))
```

(a) Display the first element of 'T1' (b) Display the last element of 'T1'

(c) Display 'T1' in reverse order. (d) Display 'Anil' from tuple 'T1'

(e) Display 'b' from tuple

Ans. (a) print(T1[0]) (b) print(T1[-1]) (c) print(T1[: :-1]) (d) print(T1[4])
(e) print(T1[5][1])

Q.8 What is unpacking Tuple?

Ans. It allows a tuple of variables on the left side of the assignment operator to be assigned respective values from a tuple on the right side. The number of variables on the left should be the same as the number of elements in the tuple.

Q.9 What are nested tuples?

Ans. A tuple containing another tuple in it as a member is called a nested tuple, e.g., the tuple shown below is a nested tuple:

```
Employees = (4580,'Rahul', (82,67,75,89,90))                      # nested tuple
```

Q.10 for i in tuple("KVS"):
 print(i+i)

Ans. KK
 VV
 SS

Very short Questions

Q.1 T1=("Hockey", "Cricket", 'Football')
 print(max(T1))
 print(min(T1))

Ans. Hockey
 Cricket

Q.2 What will be the output of the following Python Code?

```
tp = (5,)  
tp1 = tp * 2  
print(len(tp1))
```

Ans. 2

Q.3 Type Error occurs while statement 2 is running. Give reason. How can it be corrected?

```
>>> tuple1 = (5) #statement 1  
>>> len(tuple1) #statement 2
```

Ans. Because tuple1 is an integer not a tuple. So, we cannot find the length of the integer. If you want to make tuple then you should write (5,)

Q.4 How to create an empty tuple? Also create a single element tuple.

Ans. t=() or t=tuple() single element tuple: t=(10,)

Q.5 Write a program that inputs two tuples and creates a third, that contains all elements of the first followed by all elements of the second.

```

Ans. tup1 = eval(input("Enter First tuple :-"))
      tup2 = eval(input("Enter second tuple :-"))
      tup3 = tup1 + tup2
      print(tup3)

```

```

Q.6 T1=('A',['B','D'],'C')
     T1[1][1]='C'
     print(T1)

```

Ans. ('A', ['B', 'C'], 'C')

Q.7 What is the difference between a List and a Tuple?

Ans.

List	Tuple
Elements are enclosed in square brackets i.e. []	Elements are enclosed in parenthesis i.e. ()
It is mutable data type	It is immutable data type
Iterating through a list is slower as compared to tuple	Iterating through a tuple is faster as compared to list

Q.8 Which error is returned by the following code:

```

T = (10,20,30,40,50,60,70)
print(T[20])

```

Ans. Index Error : tuple index out of range

Q.9 Write a statement to print 30 from the given tuple.

```
T=("Seven",[1,2,3],[20,30,40],"eight")
```

Ans. print(T[2][1])

Q.10 Write a program to create a tuple and find sum of its alternate elements?

```

Ans. T = (10,23,30,65,70)
     sum = 0
     for a in T[0:5:2]:
         sum = sum + a
     print(sum)

```

Long Question

Q.1 Write a program to input n numbers from the user. Store these numbers in a tuple. Print the maximum and minimum number from this tuple.

```

Ans. tup= ()
     while True :

```

```

n = int(input("Enter a number :- "))
tup += (n,)
ch = input("To quit enter y/Y =")
if ch == "y" or ch=="Y":
    print(tup)
    print("Max :-",max( tup ))
    print("Min :-",min( tup ))
    break

```

Q.2 Write a program to count vowels in a tuple?

Ans.

```
T = tuple(input("Enter Name :"))
print(T)
v = 0
for ch in T:
    if ch in ['a','e','i','o','u']:
        v = v + 1
print("No. of vowels : ",v)
```

Q.3 What will be stored in variables a, b, c, d, e, f, g, h after following statements?

<pre> perc = (88, 85, 80, 88, 83, 86) a = perc[2:2] b = perc[2:] c = perc[:2] d = perc[:-2] e = perc[-2] f = perc[2:-2] g = perc[-2:2] h = perc[:] </pre>	<pre> Ans. () (80, 88, 83, 86) (88, 85) (88, 85, 80, 88) 83 (80, 88) () (88, 85, 80, 88, 83, 86) </pre>
---	---

Case Study based question

Q.1 Ram tried to create tuple t=(1,2,3) and wanted to change the value using t[1]=10 it showed error, Why.

Ans. Due to Immutable data type he cannot change

Q.2 Laxman write some code >>>T1=(10) #STM1 and >>>len(T1) #STM2 when he executes statements which error will occur and how he corrects it.

Ans. Type error will occur, corrected code will be T1=(10,)

Dictionary

Dictionary in Python is an unordered collection of data, used to store data values along with the keys. Dictionary holds the key : value pair. We can also refer to a dictionary as a mapping between a set of keys and a set of values. Each key-value pair in a Dictionary is separated by a colon (:). E.g.
`dict={"a": "alpha", "o": "omega", "g": "gamma" }`

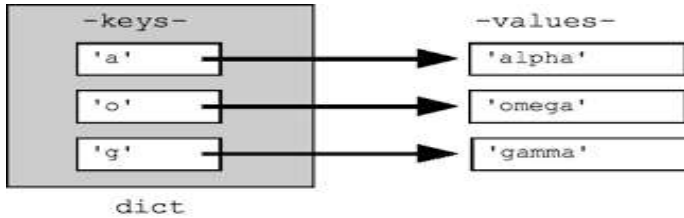

CHARACTERISTICS OF PYTHON DICTIONARY:

1. The combination of Key and Value is called Key-Value Pair.
2. Keys and their values are separated by colon(:)
3. Different Key-Value pairs are separated by comma(,).
4. Keys are unique for each Value.
5. Keys of dictionary must be of immutable type like string, number etc.

<pre># Creating an empty Dictionary Dict = {} print("Empty Dictionary: ") print(Dict) # Creating a Dictionary with Integer Keys Dict = {1: 'AAA', 2: 'BBB', 3: 'CCC'} print("\nDictionary with the use of Integer Keys: ") print(Dict) # Creating a Dictionary with Mixed keys Dict = {'Name': 'Govind', 1: [10, 11, 12, 13]} print("\nDictionary with the use of Mixed Keys: ") print(Dict) # Creating a Dictionary with dict() method D=dict({1: 'AAA', 2: 'BBB', 3:'CCC'}) print("\nDictionary with the use of dict(): ") print(D)</pre>	<p><u>Output</u> Empty Dictionary: <code>{}</code></p> <p>Dictionary with the use of Integer Keys: <code>{1: 'AAA', 2: 'BBB', 3: 'CCC'}</code></p> <p>Dictionary with the use of Mixed Keys: <code>{'Name': 'Govind', 1: [10, 11, 12, 13]}</code></p> <p>Dictionary with the use of dict(): <code>{1: 'AAA', 2: 'BBB', 3: 'CCC'}</code> Dictionary with each item as a pair: <code>{1: 'AAA', 2: 'BBB'}</code></p>
<pre># Adding elements one at a time Dict={} Dict[0] = 'Govind' Dict[2] = 'Prasad' Dict[3] = 'Arya' print("\nDictionary after adding 3 elements: ") print(Dict) # Adding set of values # to a single Key Dict['V'] = 1, 2</pre>	<p>Dictionary after adding 3 elements: <code>{0: 'Govind', 2: 'Prasad', 3: 'Arya'}</code></p> <p>Dictionary after adding set of values: <code>{0: 'Govind', 2: 'Prasad', 3: 'Arya' , 'V': (1, 2)}</code></p>

<pre>print("\nDictionary after adding set of values: ") print(Dict) # Updating existing Key's Value Dict['V'] = 3,4 print("\nUpdated dictionary: ") print(Dict)</pre>	<p>Updated dictionary: {0: 'Govind', 2: 'Prasad', 3: 'Arya' , 'V': (3, 4)}</p>
<pre># Creating a Dictionary D = {1: 'Prasad', 'name': 'Govind', 3: 'Arya'} # accessing a element using key print("Accessing a element using key:") print(D['name']) # accessing a element using key print("Accessing a element using key:") print(D[1]) # accessing a element using get() method print("Accessing a element using get:") print(D.get(3))</pre>	<p>Output Accessing a element using key: Govind</p> <p>Accessing a element using key: Prasad</p> <p>Accessing a element using get: Arya</p>
<pre>D={1:'AAA', 2:'BBB', 3:'CCC'} print("\n all key names in the dictionary, one by one:") for i in D: print(i, end=' ') print("\n all values in the dictionary, one by one:") for i in D: print(D[i], end=' ') print("\n all keys in the dictionary using keys() method:") for i in D.keys(): print(i, end=' ') print("\n all values in the dictionary using values() method:") for i in D.values(): print(i, end=' ') print("\n all keys and values in the dictionary using items()method:") for k, v in D.items(): print(k, v, end=' ')</pre>	<p>Output all key names in the dictionary, one by one: 1 2 3</p> <p>all values in the dictionary, one by one: AAA BBB CCC</p> <p>all keys in the dictionary using keys() method: 1 2 3</p> <p>all values in the dictionary using values() method: AAA BBB CCC</p> <p>all keys and values in the dictionary using items()method: 1 AAA 2 BBB 3 CCC</p>

Built-in functions in dictionary:-

Function	Example with output
len() :- Returns the length of the dictionary	D={1:'AAA', 2:'BBB', 3:'CCC'} print('Length', '=',len(D)) Output:- Length= 3
dict() :- dict() function creates a dictionary.	D = dict(name = "Aman", age = 36, country = "India") print(D) Output:- {'name': 'Aman', 'age': 36, 'country': 'India'}
keys() :- returns all the available keys	D = dict(name = "Aman", age = 36, country = "India") print(D.keys()) Output: dict_keys(['name', 'age', 'country'])
values() -returns all the available values	D = dict(name = "Aman", age = 36, country = "India") print(D.values()) Output: dict_values(['Aman', 36, 'India'])
items() :- returns key:value pair as object	D={1:'AAA', 2:'BBB', 3:'CCC'} for k, v in D.items(): print(k, v, end='#') Output: 1 AAA # 2 BBB # 3 CCC
get() : returns the value of the item with specified key	D={1:'AAA', 2:'BBB', 3:'CCC'} print(D.get(2)) Output: BBB
update() :- inserts the specified items to the dictionary	D={1:'AAA', 2:'BBB', 3:'CCC'} D.update({4:'DDD'}) print(D) Output : {1: 'AAA', 2: 'BBB', 3: 'CCC',4:'DDD'}
del() – used to delete the key:value pair	D={1:'AAA', 2:'BBB', 3:'CCC', 4:'DDD'} D.del(2) print(D) Output : {1: 'AAA', 3: 'CCC',4:'DDD'}
clear() – removes all elements from the dictionary	D={1:'AAA', 2:'BBB', 3:'CCC'} D.clear() print(D) Output : {}
fromKeys() : creates a new dictionary from the given sequence of elements with a value provided by the user.	D=(1,2,3) print(dict.fromkeys(D,None)) Output : {1: None, 3: None,4:None}
copy() : to make a copy of the dictionary	D={1:'AAA', 2:'BBB', 3:'CCC'} D1=D.copy() print(D1) Output : {1: 'AAA', 3: 'CCC',4:'DDD'}

pop() : method removes the specified item from the dictionary and return the corresponding value	D={1:'AAA', 2:'BBB', 3:'CCC'} print(D.pop(2)) Output : 'BBB'
popitem() : Remove the last item from the dictionary	D={1:'AAA', 2:'BBB', 3:'CCC'} print(D.popitem()) Output : 3: 'CCC'
setdefault() : This method inserts a new key: value pair only if the key does not exist and If the key already exists, it returns the current value in both cases.	D={1:'AAA', 2:'BBB', 3:'CCC'} print(D.setdefault(4,200)) Output : 200 D now is {1: 'AAA', 2: 'BBB', 3: 'CCC', 4: 200}
max() : returns the maximum key value	D={1:'AAA', 2:'BBB', 3:'CCC'} print(max(D)) Output : 3
min() : returns the minimum key value	D={1:'AAA', 2:'BBB', 3:'CCC'} print(min(D)) Output : 1
sorted() : returns the dictionary in sorted order on keys/values	D={10:'AAA', 2:'BBB', 3:'CCC'} print(sorted(D.items())) print(sorted(D.values())) Output : [(2, 'BBB'), (3, 'CCC'), (10, 'AAA')] ['AAA', 'BBB', 'CCC']

MIND MAP

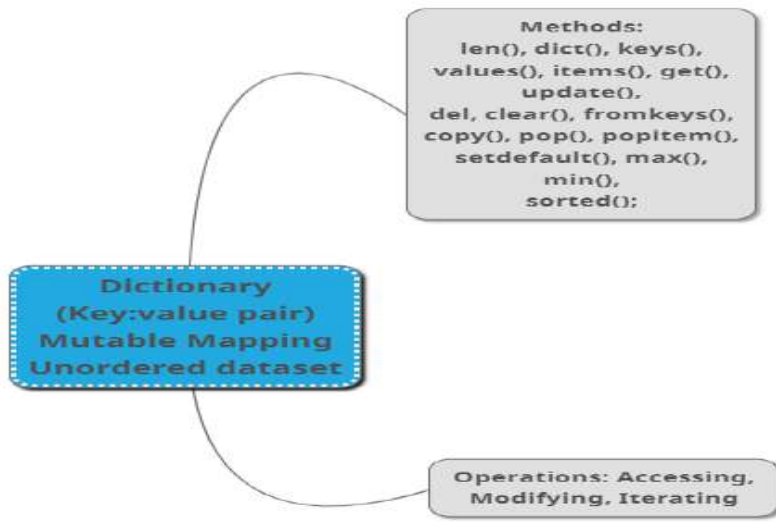

MCQ

1. What is the syntax to create an empty dictionary in Python?

- a) dict = {}
- b) dict = []
- c) dict = ()
- d) dict = None

Answer: a) dict = {}

2. Which method is used to add a new key-value pair to a dictionary?

- a) append()
- b) update()
- c) insert()
- d) add()

Answer: b) update()

3. How do you access the value of a key in a dictionary?

- a) dict[key]
- b) dict.key
- c) dict.get(key)
- d) dict[key][]

Answer: a) dict[key]

4. What happens if you try to access a key that doesn't exist in a dictionary?

- a) It returns None
- b) It raises a KeyError
- c) It returns an empty string
- d) It returns 0

Answer: b) It raises a KeyError

5. Which method is used to remove a key-value pair from a dictionary?

- a) pop()
- b) remove()
- c) delete()
- d) clear()

Answer: a) pop()

6. How do you iterate over the key-value pairs of a dictionary?

- a) for key in dict:
- b) for key, value in dict.items():
- c) for key, value in dict:
- d) for key in dict.keys():

Answer: b) for key, value in dict.items():

7. What is the output of dict.keys()?

- a) A list of keys
- b) A list of values
- c) A list of key-value pairs
- d) A dictionary

Answer: a) A list of keys

8. Which method is used to add new key value pair if not exists ?

- a) get()
- b) setdefault()
- c) add()
- d) insert()

Answer: b) setdefault()

9. How do you merge two dictionaries?

- a) dict1 + dict2
- b) dict1.update(dict2)
- c) dict1.merge(dict2)
- d) dict1.extend(dict2)

Answer: b) dict1.update(dict2)

10. What is the output of dict.clear()?

- a) An empty dictionary
- b) A dictionary with one key-value pair
- c) A dictionary with all keys removed
- d) A dictionary with all values removed

Answer: a) An empty dictionary

COMPETENCY BASED QUESTIONS

1. Write a Python function to count the frequency of each word in a given string and store the result in a dictionary.

e.g.

Input: "Hello world, hello python"

Output: {"Hello": 2, "world": 1, "python": 1}

2. Create a dictionary to store student information, including name, age, and grade. Write a function to add a new student and another function to retrieve a student's information by name.

3. Given a dictionary of student grades, write a function to calculate the average grade for each student and return the result in a new dictionary.

Input: {"John": [80, 70, 90], "Jane": [90, 80, 70]}

Output: {"John": 80.0, "Jane": 80.0}

4. Write a function to merge two dictionaries and return the result.

Input: dict1 = {"a": 1, "b": 2}, dict2 = {"c": 3, "d": 4}

Output: {"a": 1, "b": 2, "c": 3, "d": 4}

5. Create a dictionary to store book information, including title, author, and price. Write a function to find the average price of books by a specific author.

6. Given a dictionary of employee data, write a function to find the highest salary and return the employee's name and salary.

Input: {"John": 50000, "Jane": 60000, "Bob": 70000}

Output: ("Bob", 70000)

7. Write a function to remove duplicate values from a dictionary and return the result.

Input: {"a": 1, "b": 2, "c": 1, "d": 3}

Output: {"a": 1, "b": 2, "d": 3}

8. Create a dictionary to store city information, including name, population, and country.

9. With respect to Q. 8, Write a function to find cities with a population greater than a given threshold.

10. Write a small project using the concept learnt so far.

VERY SHORT QUESTIONS

1. What is the syntax to create an empty dictionary? - {} or dict()

2. How do you add a key-value pair to a dictionary? - dict[key] = value

3. How do you access a value in a dictionary? - `dict[key]`
4. What happens if you try to access a non-existent key? - `KeyError`
5. How do you remove a key-value pair from a dictionary? - `del dict[key]` or `dict.pop(key)`
6. What is the output of `dict.keys()`? - A list of keys
7. How do you merge two dictionaries? - `dict1.update(dict2)`
8. What is the output of `dict.get(key, default)`? - The value if key exists, otherwise default
9. How do you iterate over key-value pairs in a dictionary? - `for key, value in dict.items():`
10. What is the output of `dict.clear()`? - An empty dictionary

VERY LONG QUESTIONS

1. Write a Python program to create a dictionary that stores the names of students as keys and their respective grades as values. The program should also calculate the average grade of all students.
2. Develop a Python program that utilizes a dictionary to store the details of employees in a company, including their names, ages, and salaries. The program should also calculate the total salary expenditure.
3. Create a Python dictionary that stores the names of cities as keys and their respective populations as values. Write a program that includes functions to find the city with the highest population.
4. Design a Python program that employs a dictionary to store the details of books in a library, including their titles, authors, and publication years. The program should also find books by a specific author.
5. Write a Python program that utilizes a dictionary to store the details of customers in an e-commerce platform, including their names, addresses, and order histories. The program should find the customer with the highest total order value.
6. Develop a Python program that uses a dictionary to store the details of courses in an online learning platform, including their titles, descriptions, and prices. The program should find courses by a specific title.
7. Create a Python dictionary that stores the names of countries as keys and their respective capitals as values. Write a program that finds the capital of a specific country, calculate the number of countries in the dictionary, and add a new country to the dictionary.
8. Design a Python program that employs a dictionary to store the details of patients in a hospital, including their names, ages, and medical records. The program should find patients by a specific age range.
9. Write a Python program that utilizes a dictionary to store the details of products in an inventory management system, including their names, quantities, and prices. The program should update the quantity of a product.
10. Develop a Python program that uses a dictionary to store the details of flights in an airline management system, including their numbers, departure times, and arrival times. The program should find flights based on its number, and add a new flight to the dictionary.

Modules in Python

A module is simply a python file where statements,

classes, Objects, functions, constants and variables are defined. The file name is the module name with .py extension. Definitions from a module can be *imported* into other modules. It is a kind of code library.

We can use the module we created, by using the ***import*** statement.

How to import modules in Python?

Python module can be accessed in any of following ways.

1. Python import statement
import math
print("2 to the power 3 is ", math.pow(2,3))
Just similar to math ,user defined module can be accessed using import statement
2. Import with renaming
import math as mt
print("2 to the power 3 is ", mt.pow(2,3))
3. Python from...import statement
from math import pow
print("2 to the power 3 is ", pow(2,3))
4. Import all names
from math import *
print("2 to the power 3 is ", pow(2,3))

Functions of math module:

To work with the functions of the math module, we must import the math module in the program.

import math

S. No.	Function	Description	Example
1	sqrt()	Returns the square root of a number	>>>math.sqrt(49) 7.0
2	ceil()	Returns the upper integer	>>>math.ceil(81.3) 82
3	floor()	Returns the lower integer	>>>math.floor(81.3) 81
4	pow()	Calculate the power of a number	>>>math.pow(2,3) 8.0
5	fabs()	Returns the absolute value of a number	>>>math.fabs(-5.6) 5.6

6	sin()	Returns the sine of a number	>>>math.sin(90) 0.89399
7	cos()	Returns the cosine of a number	>>>math.cos(90) -0.448073
8	tan()	Returns the tangent of a number	>>>math.tan(90) -1.995200

Functions of random module:

To work with the functions of a random module, we must import a random module in the program.

import random

S. No.	Function	Description	Example
1	random ()	It returns a random float x, such that $0 \leq x < 1$	>>>random.random() 0.281954791393
2	randint(a, b)	It returns a int x between a & b such that $a \leq x \leq b$	>>>random.randint(1,10) 5
3	Randrange ([start,] stop [,step])	It returns a random item from the given range upto stop-1.	>>>random.randrange(100,1000,3) 150

Functions of statistics module:

To work with the functions of the statistics module, we must import the statistics module in the program.

import statistics

S. No.	Function	Description	Example
1	mean ()	It returns mean of a list of numbers	>>> print(statistics.mean([1, 3, 5, 7, 9, 11])) 6
2	median()	It returns the median (middle value) of the given data set	>>> print(statistics.median([1, 3, 5, 7, 9, 11, 13])) 7

3	mode()	It returns the mode (central tendency) of the given numeric or nominal data set.	>>> print(statistics.mode([1, 3, 3, 3, 5, 7, 7, 9])) 3
---	--------	--	---

MINDMAP

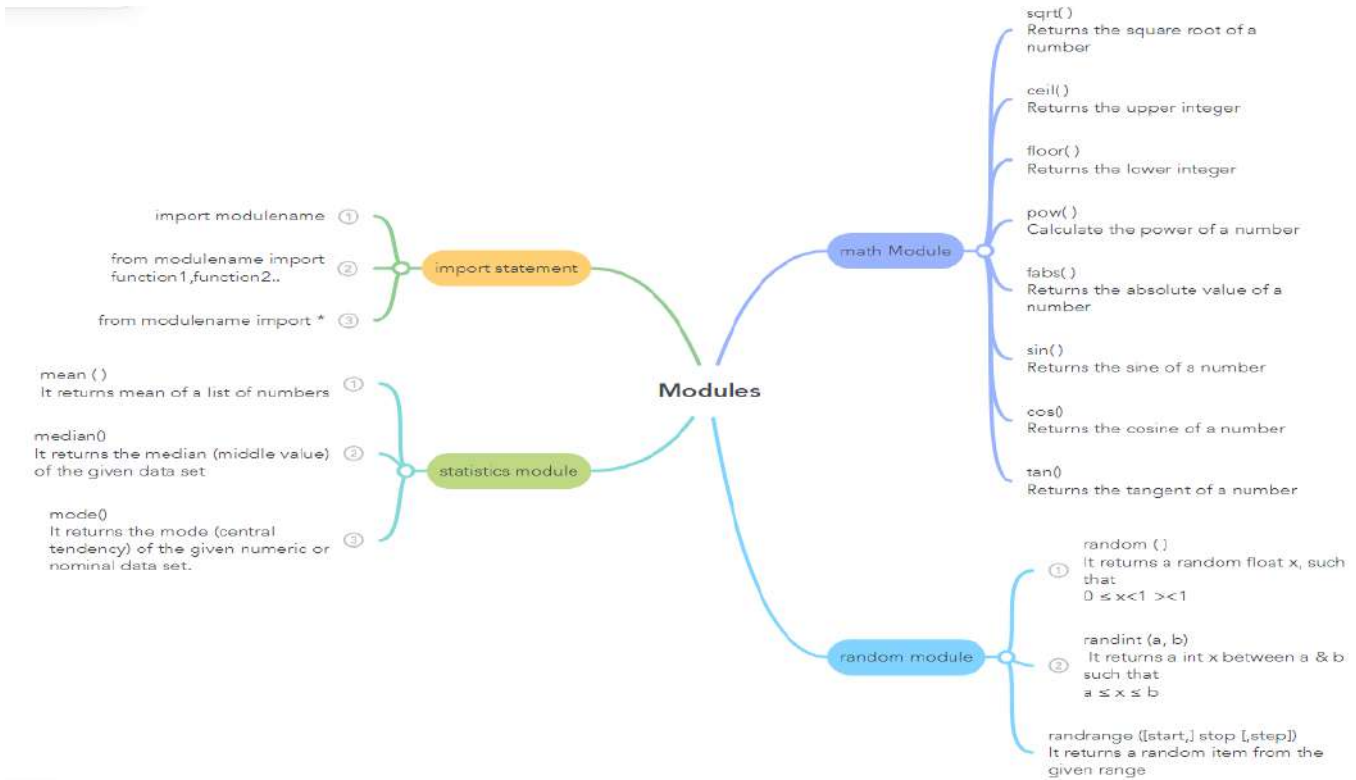

MCQ

1	<p>Study the following program and select the possible output(s) from the options (i) to (iv) following it. Also, write the maximum and the minimum values that can be assigned to the variable Y.</p> <pre>import random X=random.random() Y=random.randint(1,4) print(int(X),":",Y+int(X))</pre> <p>i) 0 : 0 ii) 1 : 6 iii) 2 : 4 iv) 0 : 3</p>
2	<p>Observe the following program and answer the questions that follow:</p> <pre>import random X=3 N=random.randint(1,X) for i in range(N): print (i,"#",i+1)</pre>

	a) What is the minimum and maximum number of times the loop will execute?
	b) Find out, which line of output(s) out of (i) to (iv) will not be expected from the program?
	(i) 0#1 (ii) 1#2 (iii) 2#3 (iv) 3#4
3	What possible outputs(s) are expected to be displayed on screen at the time of execution of the program from the following code? Also specify the maximum values that can be assigned to each of the variables FROM and TO.
	<pre>import random AR=[20,30,40,50,60,70]; FROM=random.randint(1,3) TO=random.randint(2,4) for K in range(FROM,TO+1): print (AR[K],end="#" "</pre>
	(i) 10#40#70# (ii) 30#40#50# (iii)50#60#70# (iv) 40#50#70#
4	What possible outputs(s) are expected to be displayed on screen at the time of execution of the program from the following code? Also specify the maximum values that can be assigned to each of the variables START and END. 2
	<pre>import random SCORE=[20,40,10,30,15]; START=random.randint(1,3) END=random.randint(2,4) for I in range(START,END+1): print(SCORE[I],"&")</pre>
	(i) 10&40&20& (ii) 10&30&15& (iii) 40&10&30& (iv) 20&40&10&
5	What are the possible outcome(s) executed from the following code? Also specify the maximum and minimum values that can be assigned to variable N.
	<pre>import random PLAY=[40,50,10,20]"EAST","WEST","NORTH","SOUTH"; ROUND=random.randint(2,3) for J in range(ROUND,1,-1): print PLAY[J],":"</pre>
	(i) 20:10: (ii) 20:10:50: (iii) 20: (iv) 40:50:20:
6	What possible output(s) are expected to be displayed on screen at the time of execution of the program from the following code ? Also specify the maximum values that can be assigned to each of the variables BEGIN and LAST. 2
	import random

```

POINTS=[20,40,10,30,15]
POINTS=[30,50,20,40,45]
BEGIN=random.randint(1,3)
LAST=random.randint(2,4)
for C in range(BEGIN, LAST+1):
    print POINTS[C], "#"

```

(i) 20#50#30# (ii) 20#40#45# (iii) 50#20#40# (iv) 30#50#20#

Very Short Answers

- 1 Predict the output:

```

from math import *
x=12
y=10 * sqrt(pow(x,2))

```
- 2 Identify the errors and correct them:

```

Import math
Y=36
S=sqrt(Y)
Print(S)

```
- 3 Predict the output:

```

import math
num=14.14
print(math.ceil(num))
print(math.floor(num))

```
- 4 Predict the output: (What are the maximum and minimum possible values?)

```

import random
print(random.random(5))

```
- 5 Predict the output:

```

li=[1,2,3,4,5,6,7,8,9,10]
from statistics import *
print(mean(li))
print(median(li))

```
- 6 Identify the errors and correct them:

```

li=[1,2,3,4,5,6,7,8,9,10]
from statistics import *
print(li.mean())
print(statistics.median(li))

```
- 7 Predict the output: (What are the possible values?)

```

import random
print(random.randint(5,10))

```
- 8 Predict the output: (What are the possible values?)

```

import random
print(random.randrange(10,20,2))

```
- 9 Write program to find square root of a function using math module
- 10 Predict the output:

```

li=[1,2,3,4,4,4,4,4,5,5,5,5,5,6,7,8,8,8,8,9,10]
from statistics import *
print(mode(li))

```

Unit III: Society, Law, and Ethics

Digital footprints

Digital footprints are the traces of data that individuals leave behind while using the internet. These footprints can be categorized into two main types: active and passive.



Types of Digital Footprints

1. Active Digital Footprints:

- **Social Media Posts:** Updates, photos, and comments on platforms like Facebook, Instagram, and Twitter.
- **Emails:** Sent and received emails.
- **Online Forms:** Information filled out on online forms, surveys, or registrations.
- **Blog Posts and Comments:** Content published on blogs or comments left on various websites.
- **Online Purchases:** Information about items bought online, including reviews and feedback.

2. Passive Digital Footprints:

- **Browsing History:** Records of websites visited, even if not actively interacting with them.
- **IP Addresses:** Data associated with the IP addresses that identify devices on the internet.
- **Cookies:** Small files stored on devices by websites to track user behavior and preferences.
- **Location Data:** Information on where a device has been, often collected through apps and services.

Importance and Implications

- **Privacy Concerns:** Digital footprints can reveal personal information, leading to privacy breaches if not managed properly.
- **Security Risks:** Hackers can exploit digital footprints to gain unauthorized access to personal and financial data.
- **Personal Branding:** Online presence, including professional networks and personal posts, contributes to one's personal brand.
- **Data Analytics:** Businesses use digital footprints to analyse consumer behaviour and preferences for targeted marketing.

Managing Digital Footprints

1. **Privacy Settings:** Regularly update privacy settings on social media and other platforms to control what information is shared publicly.
2. **Clear Browsing Data:** Frequently clear cookies and browsing history to minimize passive footprints.
3. **Use Strong Passwords:** Implement strong, unique passwords for different accounts to protect against unauthorized access.
4. **Be Mindful of Sharing:** Think twice before posting personal information online and avoid oversharing.
5. **Use Encryption:** Use encrypted communication methods for sensitive information to enhance security.

Digital Society and Netizen: net etiquettes, communication etiquettes, social media etiquettes



Netiquette Netiquette refers to the correct or acceptable way of communicating on the internet. Key principles include:

1. **Be Respectful:** Treat others with respect, regardless of differences in opinions or beliefs.
2. **Avoid Trolling:** Do not post inflammatory or offensive comments to provoke others.
3. **Respect Privacy:** Do not share personal information of others without their consent.
4. **Use Appropriate Language:** Avoid using foul or abusive language.
5. **Be Constructive:** Provide constructive feedback and engage in meaningful discussions.

Communication Etiquettes

Communication etiquette involves proper conduct when communicating via digital means, including email, instant messaging, and video calls. Important guidelines are:

1. **Clear and Concise Messages:** Keep messages clear and to the point.
2. **Professional Tone:** Maintain a professional tone, especially in work-related communications.
3. **Timely Responses:** Respond to messages in a timely manner to maintain effective communication.
4. **Proper Formatting:** Use proper grammar, spelling, and formatting.
5. **Subject Lines:** Use relevant subject lines in emails to indicate the content of the message.

Social Media Etiquettes **Social media etiquette** encompasses the proper way of interacting on platforms like Facebook, Twitter, Instagram, and LinkedIn. Key practices include:

1. **Respectful Interaction:** Engage respectfully with others, avoiding arguments and personal attacks.
2. **Think Before Posting:** Consider the potential impact and permanence of posts before sharing.
3. **Credit Sources:** Always credit original sources when sharing content created by others.
4. **Be Authentic:** Maintain authenticity and honesty in your posts and interactions.
5. **Avoid Spamming:** Do not flood timelines or feeds with excessive posts, tags, or messages.

Data protection

Data protection encompasses various aspects of safeguarding information and respecting intellectual property rights (IPR). Understanding the different types of IPR, recognizing violations, and comprehending open-source software and licensing are crucial in the digital age.



Intellectual Property Rights (IPR)

Intellectual property rights are legal rights that protect creations of the mind. These include:

1. **Copyright:**
 - **Definition:** Protects original works of authorship such as literature, music, and art.
 - **Duration:** Generally lasts for the lifetime of the author plus 70 years.
 - **Rights Granted:** Exclusive rights to reproduce, distribute, perform, display, or license the work.
2. **Patent:**
 - **Definition:** Protects new inventions or discoveries.
 - **Duration:** Typically lasts for 20 years from the filing date.
 - **Rights Granted:** Exclusive rights to make, use, sell, and import the invention.
3. **Trademark:**
 - **Definition:** Protects symbols, names, and slogans used to identify goods or services.
 - **Duration:** Can last indefinitely, as long as the trademark is in use and properly renewed.
 - **Rights Granted:** Exclusive rights to use the mark in commerce and to prevent others from using similar marks that could cause confusion.

Violation of IPR

Violations of intellectual property rights include:

1. **Plagiarism:**
 - **Definition:** The act of using someone else's work or ideas without proper attribution.
 - **Implications:** Academic and professional consequences, legal penalties, and reputational damage.
2. **Copyright Infringement:**
 - **Definition:** Unauthorized use of copyrighted material.
 - **Examples:** Copying and distributing music, movies, books, or software without permission.
 - **Penalties:** Legal action, fines, and potential imprisonment.
3. **Trademark Infringement:**
 - **Definition:** Unauthorized use of a trademark that causes confusion about the origin of goods or services.
 - **Examples:** Using a similar logo or brand name to mislead consumers.
 - **Penalties:** Legal action, financial damages, and injunctions against further use.

Open-Source Software and Licensing

Open-source software is software with source code that anyone can inspect, modify, and enhance. Key open-source licenses include:

1. **Creative Commons (CC):**
 - **Purpose:** Provides a variety of licenses that creators can use to specify permissions for their works.
 - **Types:** Ranges from the most permissive (CC BY) to the most restrictive (CC BY-NC-ND).
2. **General Public License (GPL):**
 - **Purpose:** Ensures that software remains free and open, requiring any derivative works to also be distributed under the same license.
 - **Key Feature:** Copyleft provision, which mandates that modifications and derived works must be open source under the GPL.
3. **Apache License:**
 - **Purpose:** Provides a permissive license allowing users to use the software for any purpose, distribute it, modify it, and distribute modified versions.
 - **Key Feature:** Does not require derivative works to be open source, allowing for incorporation into proprietary projects.

Cyber Crime:

Cyber crime encompasses illegal activities conducted via the internet or other computer networks. These crimes exploit vulnerabilities in digital systems and can cause significant harm to individuals, organizations, and society at large. Key types of cyber crime include hacking, eavesdropping, phishing, ransomware, cyber trolling, and cyber bullying.



Cyber Crime:

- **Definition:** Illegal activities conducted using computers, networks, or the internet.
- **Impact:** Can lead to financial loss, data breaches, identity theft, and emotional distress.

Types of Cyber Crime

1. Hacking:

- **Definition:** Unauthorized access to computer systems or networks.
- **Methods:** Exploiting vulnerabilities, using malware, or brute force attacks.
- **Consequences:** Data theft, system damage, and loss of privacy.

2. Eavesdropping:

- **Definition:** Intercepting private communications without permission.
- **Methods:** Man-in-the-middle attacks, network sniffing.
- **Consequences:** Exposure of sensitive information, loss of confidentiality.

3. Phishing and Fraud Emails:

- **Definition:** Fraudulent attempts to obtain sensitive information by masquerading as a trustworthy entity.
- **Methods:** Fake emails, websites, or messages that prompt recipients to provide personal information.
- **Consequences:** Identity theft, financial loss, and unauthorized access to accounts.

4. Ransomware:

- **Definition:** Malware that encrypts a victim's data and demands payment for the decryption key.
- **Methods:** Phishing emails, malicious downloads, exploit kits.
- **Consequences:** Data loss, financial extortion, and operational disruptions.

5. Cyber Trolls:

- **Definition:** Individuals who deliberately provoke or harass others online to elicit emotional responses.
- **Methods:** Posting inflammatory, off-topic, or offensive comments.
- **Consequences:** Disruption of online communities, psychological distress.

6. Cyber Bullying:

- **Definition:** The use of digital communication tools to bully, harass, or intimidate someone.
- **Methods:** Social media harassment, threatening messages, spreading rumors.
- **Consequences:** Emotional trauma, mental health issues, and, in severe cases, suicidal thoughts.

Cyber Safety

Cyber safety involves practices and measures to protect oneself and one's information while using the internet. It includes safely browsing the web, protecting your identity, and maintaining the confidentiality of your data.



Safely Browsing the Web

1. Use Secure Connections:

- **HTTPS:** Always check that websites use HTTPS instead of HTTP. The 'S' stands for secure, meaning that the data sent between your browser and the website is encrypted.
- **VPN:** Use a Virtual Private Network (VPN) to encrypt your internet connection, especially when using public Wi-Fi. This prevents attackers from eavesdropping on your online activities.

2. Avoid Suspicious Websites:

- **Check URLs:** Be cautious of URLs that look unusual or unfamiliar. Cybercriminals often use slightly altered URLs to trick users into visiting malicious sites.
- **Security Indicators:** Look for a padlock icon in the address bar and verify the site's certificate to ensure it's legitimate.

3. Use Safe Browsing Tools:

- **Browser Extensions:** Install extensions that block ads, trackers, and malicious sites. Examples include uBlock Origin and Privacy Badger.
- **Antivirus Software:** Use reputable antivirus software that provides real-time protection against malware and phishing attempts.

4. Regularly Update Software:

- **Browsers and OS:** Keep your web browser and operating system up to date to protect against security vulnerabilities.
- **Plugins:** Update plugins like Java and Flash or disable them if not needed, as they can be exploited by attackers.

5. Be Cautious with Downloads:

- **Sources:** Download software and files only from trusted sources. Avoid pirated software, as it can contain malware.
- **Scans:** Use antivirus software to scan files before opening them.

Identity Protection

1. **Use Strong Passwords:**
 - **Complexity:** Create passwords that are at least 12 characters long and include a mix of letters, numbers, and special characters.
 - **Uniqueness:** Avoid reusing passwords across different accounts. Use unique passwords for each account.
2. **Enable Two-Factor Authentication (2FA):**
 - **Extra Security:** Enable 2FA on all accounts that offer it. This adds an extra layer of security by requiring a second form of verification, such as a code sent to your phone.
 - **Methods:** Use authentication apps like Google Authenticator or Authy instead of SMS-based 2FA for better security.
3. **Be Wary of Phishing Scams:**
 - **Emails and Links:** Be cautious of emails or messages asking for personal information or containing suspicious links. Verify the sender's email address and look for signs of phishing.
 - **Attachments:** Do not open attachments from unknown sources.
4. **Monitor Personal Information:**
 - **Credit Reports:** Regularly check your credit reports for any suspicious activity.
 - **Account Activity:** Monitor your bank and online accounts for unauthorized transactions.

Confidentiality

1. **Data Encryption:**
 - **Storage:** Encrypt sensitive data stored on your devices. Tools like BitLocker (Windows) or FileVault (Mac) can encrypt your hard drive.
 - **Communication:** Use encrypted communication tools for sending sensitive information. Apps like Signal and WhatsApp offer end-to-end encryption.
2. **Secure Backups:**
 - **Regular Backups:** Regularly back up important data to an external drive or cloud service. Ensure that backups are encrypted and stored securely.
 - **Offsite Storage:** Consider using an offsite location for storing backups to protect against physical threats like theft or fire.
3. **Access Controls:**
 - **Permissions:** Restrict access to sensitive information based on user roles. Ensure that only authorized individuals have access to certain data.
 - **Authentication:** Use strong authentication methods for accessing sensitive systems and data.
4. **Secure Disposal:**
 - **Data Wiping:** Use secure methods to erase data from devices before disposal. Simply deleting files is not enough; use tools that perform a complete wipe of the storage.
 - **Physical Destruction:** For highly sensitive information, consider physically destroying storage media to ensure data cannot be recovered.

Malware

Malware, short for malicious software, is any software intentionally designed to cause damage to a computer, server, client, or computer network. Malware can steal, encrypt, or delete data, alter or hijack core computing functions, and spy on computer activity without the user's knowledge or permission.

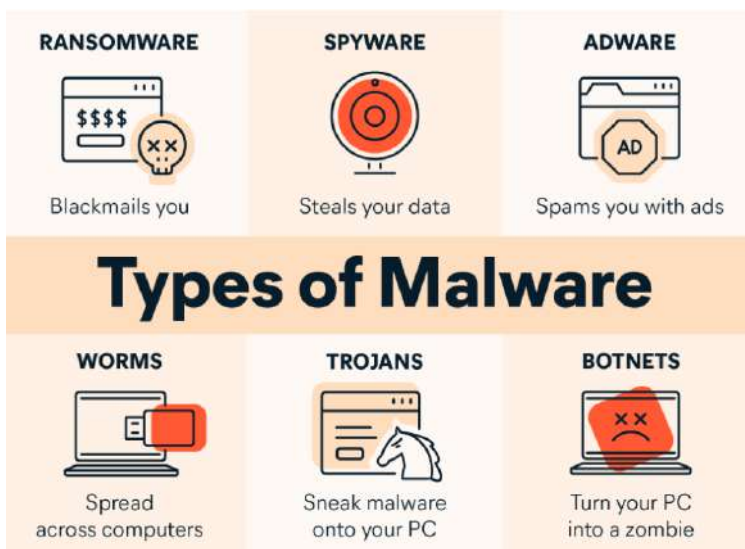

1. Viruses

Definition: A computer virus is a type of malware that attaches itself to a legitimate program or file and spreads to other programs and files on the same system, eventually affecting other systems.

Characteristics:

- **Replication:** Viruses can replicate themselves and spread to other programs and files when the infected program or file is executed.
- **Activation:** Often, viruses lay dormant until the infected file is run or a specific condition is met.
- **Payload:** They can carry a payload that performs malicious actions like corrupting data, logging keystrokes, or even creating backdoors.

Prevention and Protection:

- **Antivirus Software:** Regularly update and run antivirus software to detect and remove viruses.
- **Avoid Suspicious Links and Downloads:** Be cautious when opening email attachments or downloading files from unknown sources.
- **System Updates:** Keep your operating system and applications up-to-date to protect against known vulnerabilities.

2. Trojans

Definition: A Trojan horse, or Trojan, is a type of malware that disguises itself as legitimate software. Users are typically tricked into loading and executing Trojans on their systems.

Characteristics:

- **Deception:** Trojans appear as harmless or useful software but perform malicious activities once installed.
- **Variety of Malicious Actions:** They can create backdoors, steal information, or download additional malware.

- **No Self-Replication:** Unlike viruses and worms, Trojans do not replicate themselves but rely on social engineering to spread.

Types of Trojans:

- **Backdoor Trojans:** Allow remote control over the infected system.
- **Downloader Trojans:** Download and install other malicious software.
- **Spyware Trojans:** Monitor user activities and steal sensitive information.
- **Banking Trojans:** Target online banking credentials and financial information.

Prevention and Protection:

- **Download from Trusted Sources:** Only download software from reputable and official sources.
- **Be Wary of Unexpected Emails:** Avoid downloading or opening attachments from unknown or unexpected email sources.
- **Security Software:** Use comprehensive security software that can detect and block Trojans.

3. Adware

Definition: Adware is a type of malware that automatically delivers advertisements to the user's device. It is often bundled with free software and installed without the user's knowledge or consent.

Characteristics:

- **Pop-Up Ads:** Generates frequent and intrusive advertisements, often in the form of pop-up windows.
- **User Tracking:** Adware can track the user's browsing habits and send this data back to advertisers.
- **Performance Impact:** Can slow down system performance and use up bandwidth.

Types of Adware:

- **Legitimate Adware:** Comes with user consent, often bundled with freeware or shareware, and can usually be removed by uninstalling the associated software.
- **Potentially Unwanted Programs (PUPs):** Adware that is installed without explicit user consent and is often more difficult to remove.

Prevention and Protection:

- **Adblockers:** Use browser extensions that block ads and pop-ups.
- **Careful Installation:** Pay attention to installation prompts and opt out of installing additional software that you do not need.
- **Anti-Adware Tools:** Use security software that can detect and remove adware.

E-waste management:

E-waste, or electronic waste, refers to discarded electronic appliances and devices. With the rapid pace of technological advancement, the accumulation of e-waste has become a significant environmental issue. Proper e-waste management is essential to mitigate its harmful effects on the environment and human health.



Importance of Proper E-Waste Management

1. **Environmental Protection:** E-waste contains hazardous materials such as lead, mercury, cadmium, and brominated flame retardants, which can contaminate soil and water if not disposed of properly.
2. **Resource Conservation:** Many electronic devices contain valuable materials like gold, silver, copper, and rare earth elements. Proper recycling can recover these materials and reduce the need for mining new resources.
3. **Health Protection:** Improper disposal and informal recycling processes can expose workers and the public to toxic substances, leading to health issues like respiratory problems, skin diseases, and neurological damage.

Steps for Proper E-Waste Management

1. **Reduce, Reuse, and Recycle:**
 - **Reduce:** Minimize e-waste generation by buying only what you need, choosing durable products, and avoiding unnecessary upgrades.
 - **Reuse:** Extend the life of your electronic devices by repairing them, donating them to others, or selling them.
 - **Recycle:** Ensure that old and non-functional devices are recycled properly through authorized e-waste recycling programs.
2. **Identify E-Waste:**
 - **Common E-Waste Items:** Computers, laptops, mobile phones, tablets, televisions, printers, refrigerators, and other household appliances.
 - **Batteries and Accessories:** Include batteries, chargers, earphones, and other electronic accessories in your e-waste disposal plans.
3. **Responsible Disposal:**
 - **Certified E-Waste Recyclers:** Use certified e-waste recycling services to ensure that the devices are dismantled and recycled in an environmentally friendly manner.
 - **Manufacturer Take-Back Programs:** Many electronics manufacturers offer take-back programs to recycle their products. Check with the manufacturer or retailer for such programs.
 - **Municipal Collection Programs:** Participate in local government e-waste collection events or drop-off programs.
4. **Data Security:**

- **Data Wiping:** Before disposing of or recycling electronic devices, ensure that all personal data is securely erased. Use software tools to wipe data from hard drives, phones, and other storage devices.
 - **Physical Destruction:** For highly sensitive data, consider physically destroying the storage media to prevent data recovery.
5. **Regulations and Guidelines:**
- **Follow Local Laws:** Adhere to local, state, and national regulations regarding e-waste disposal and recycling.
 - **Stay Informed:** Keep updated with guidelines and best practices for e-waste management from reputable sources such as environmental organizations and government agencies.

E-Waste Recycling Process

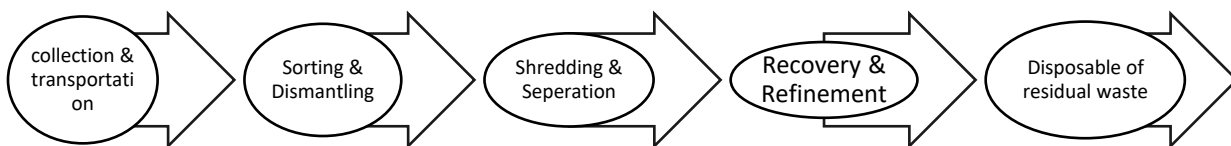

1. **Collection and Transportation:**
 - E-waste is collected from various sources, including households, businesses, and institutions, and transported to recycling facilities.
2. **Sorting and Dismantling:**
 - Devices are manually sorted and dismantled into various components, such as plastics, metals, circuit boards, and glass.
3. **Shredding and Separation:**
 - The dismantled components are further shredded into smaller pieces and separated using techniques like magnetic separation (for ferrous metals), eddy current separation (for non-ferrous metals), and flotation (for plastics).
4. **Recovery and Refinement:**
 - Precious metals and other valuable materials are extracted and refined using chemical and electrochemical processes.
5. **Disposal of Residual Waste:**
 - Non-recyclable and hazardous materials are disposed of in compliance with environmental regulations to minimize environmental impact.

Information Technology Act (IT Act)

The Information Technology Act (IT Act), enacted in 2000 in India, is a comprehensive legal framework to address the issues related to cybercrime and electronic commerce. Here are the basic points of the IT Act:

1. Objective

- **Primary Purpose:** To provide legal recognition for transactions carried out by means of electronic data interchange and other means of electronic communication, commonly referred to as "e-commerce".
- **Cybercrime:** To address the emerging legal issues related to online activities, cybercrime, and digital signatures.

2. Key Provisions

- **Legal Recognition of Electronic Documents:** Provides legal recognition to electronic documents, thus facilitating electronic governance.
- **Digital Signatures:** Legal recognition of digital signatures for the authentication of electronic records.
- **Certifying Authorities:** Establishes a framework for the accreditation of certifying authorities, who issue digital certificates.
- **Electronic Contracts:** Recognition of electronic contracts, making them legally enforceable.

3. Offenses and Penalties

- **Unauthorized Access:** Penalties for gaining unauthorized access to computer systems, including hacking.
- **Data Theft:** Punishments for stealing data stored in a computer, such as copying or extracting data without permission.
- **Virus Attacks:** Penalties for introducing viruses, worms, or other malicious software into computer systems.
- **Identity Theft:** Penalties for identity theft and fraud involving the use of digital identities.
- **Cyber Terrorism:** Stringent penalties for cyber terrorism activities.

4. Adjudication and Regulation

- **Cyber Appellate Tribunal:** Establishment of a Cyber Appellate Tribunal to handle appeals against orders from adjudicating officers related to contraventions under the Act.
- **Regulation of Certifying Authorities:** Guidelines for the regulation and functioning of certifying authorities who issue digital signatures.
- **Appointment of Adjudicating Officers:** Appointment of adjudicating officers to handle disputes and grievances related to the provisions of the IT Act.

5. Amendments and Updates

- **IT (Amendment) Act, 2008:** Significant amendments to address evolving cyber threats, including:
 - **Child Pornography:** Prohibition of child pornography and punishments for related offenses.
 - **Phishing and Spam:** Provisions to combat phishing attacks and spamming.
 - **Data Protection:** Introduction of data protection measures, including safeguards for sensitive personal information.

6. E-Governance and E-Commerce

- **Electronic Governance:** Promotion of electronic governance and the use of digital signatures for government transactions.
- **E-Commerce:** Legal recognition and facilitation of electronic commerce, making online business transactions legally binding.

7. Liability of Intermediaries

- **Intermediary Guidelines:** Defines the roles and responsibilities of intermediaries (e.g., ISPs, web hosts) in managing and removing unlawful content.
- **Safe Harbor Provisions:** Provides safe harbor protection to intermediaries, limiting their liability for third-party content under certain conditions.

8. Miscellaneous Provisions

- **Privacy Protection:** Provisions to safeguard the privacy of individuals and data protection requirements.
- **Computer Resource Tampering:** Penalties for tampering with computer resources, including data alteration and system interference.
- **Confidentiality:** Obligations on maintaining the confidentiality and security of electronic records and digital signatures.

Technology and society: Gender and disability issues while teaching and using computers

Technology plays a pivotal role in modern society, impacting various facets of life, including education and accessibility for different demographics such as gender and individuals with disabilities. Here’s an exploration of how technology interacts with these issues in teaching and computer use:

Gender Issues:

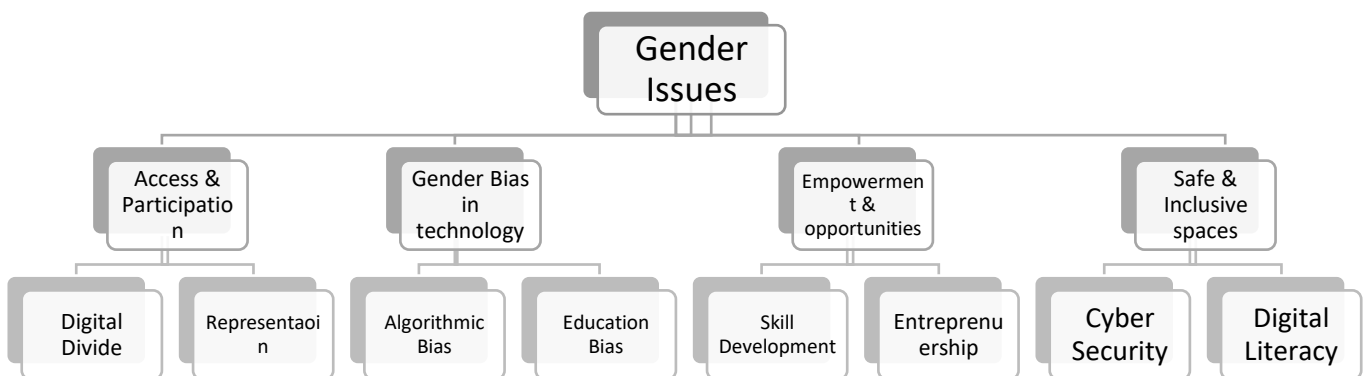

Disability Issues

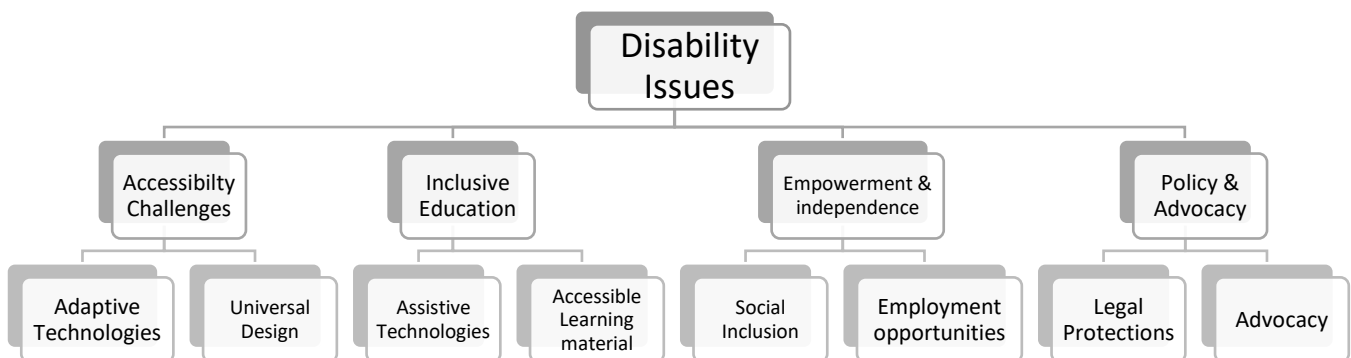

Multiple choice questions

- 1) **Which of the following best describes a digital footprint?**
 - A. The physical trails left behind by someone on the internet
 - B. The environmental impact of digital devices
 - C. The collection of all the traces and activities someone leaves online
 - D. The programming languages used in digital technology

- 2) **What can contribute to your digital footprint?**
 - A. Browsing websites
 - B. Posting on social media
 - C. Sending emails
 - D. All of the above

- 3) **Which of the following actions can help you manage and reduce your digital footprint?**
 - A. Regularly clearing your browser history and cookies
 - B. Using strong, unique passwords for different accounts
 - C. Adjusting privacy settings on social media platforms
 - D. All of the above

- 4) **Which of the following is considered good netiquette when participating in an online discussion?**
 - A. Using all caps to emphasize your points
 - B. Respecting others' opinions and responding politely
 - C. Posting off-topic comments
 - D. Ignoring other participants' contributions

- 5) **What should you do if you receive an email that appears to be a phishing attempt?**
 - A. Forward it to all your contacts
 - B. Click on any links to verify if they are safe
 - C. Delete the email and report it to your email provider
 - D. Reply to the email asking for more information

- 6) **When composing an email, which of the following practices is considered appropriate netiquette?**
 - A. Using informal language regardless of the recipient
 - B. Keeping your message clear and concise
 - C. Ignoring spelling and grammar errors
 - D. Using vague subject lines

- 7) **What is the primary purpose of data protection laws?**
 - A. To prevent data from being stored
 - B. To ensure the free flow of data
 - C. To safeguard personal information from unauthorized access or disclosure

D. To make data publicly available

8) Which of the following is a key principle of the General Data Protection Regulation (GDPR)?

- A. Data must be processed unlawfully
- B. Data can be collected without any specific purpose
- C. Individuals have the right to access and control their personal data
- D. Personal data must be stored indefinitely

9) Which practice helps protect data when sharing it electronically?

- A. Sending data over unencrypted email
- B. Using strong passwords and encryption
- C. Sharing passwords with others
- D. Keeping default security settings

10) Which of the following is an example of phishing?

- A. Installing antivirus software
- B. Sending emails that appear to be from a legitimate source to steal personal information
- C. Developing a new software application
- D. Creating a strong password

11) Which type of cyber-crime involves taking control of someone's computer to use it for sending spam or launching attacks?

- A. Identity theft
- B. Hacking
- C. Ransomware
- D. Botnet

12) What is the primary goal of ransomware?

- A. To steal personal information for identity theft
- B. To encrypt the victim's data and demand payment for the decryption key
- C. To create backup copies of data
- D. To monitor internet usage

13) Which of the following is a good practice to ensure cyber safety when using public Wi-Fi?

- A. Accessing sensitive accounts, such as online banking
- B. Using a VPN (Virtual Private Network)
- C. Disabling firewall protection
- D. Sharing personal information freely

14) What is two-factor authentication (2FA)?

- A. A method of logging into accounts using two different passwords
- B. A security process in which the user provides two different authentication factors to verify themselves
- C. A way to create a backup of your data

D. A method of encrypting files on your computer

15) **Which of the following actions can help protect against malware infections?**

- A. Clicking on unknown links in emails
- B. Regularly updating your software and operating system
- C. Downloading files from untrusted sources
- D. Disabling antivirus software

16) **Which of the following best describes malware?**

- A. Software designed to protect your computer from viruses
- B. Malicious software intended to damage or disable computers and computer systems
- C. A type of hardware that speeds up your computer
- D. An operating system feature

17) **What type of malware disguises itself as legitimate software but performs malicious activities?**

- A. Virus
- B. Trojan Horse
- C. Worm
- D. Spyware

18) **Which type of malware replicates itself in order to spread to other computers?**

- A. Adware
- B. Spyware
- C. Worm
- D. Ransomware

19) **What is the primary goal of e-waste management?**

- A. To increase the production of electronic devices
- B. To dispose of electronic waste in landfills
- C. To recycle and properly dispose of electronic waste to minimize environmental impact
- D. To store electronic waste indefinitely

20) **Which of the following is a common practice in e-waste recycling?**

- A. Burning electronic devices to retrieve metals
- B. Disposing of electronic waste in household trash bins
- C. Dismantling electronic devices to recover valuable materials
- D. Using electronic devices as landfill cover

21) **What is a significant environmental concern associated with improper e-waste disposal?**

- A. Increase in the production of new electronics
- B. Contamination of soil and water with toxic substances
- C. Decrease in electronic device prices
- D. Improvement in landfill efficiency

22) **Which of the following is a primary objective of the Information Technology Act, 2000?**

- A. To regulate the use of mobile phones
- B. To provide legal recognition for electronic transactions
- C. To establish guidelines for television broadcasting
- D. To manage public libraries

23) **Which of the following is considered a cybercrime under the Information Technology Act, 2000?**

- A. Unauthorized access to computer systems
- B. Physical theft of hardware
- C. Traditional forms of fraud
- D. Plagiarism in academic writing

24) **Which of the following is an important consideration regarding gender and computer use in education?**

- A. Providing equal access to computer labs for all students
- B. Restricting computer use based on gender preferences
- C. Limiting girls' access to programming courses
- D. Allowing only boys to use advanced software tools

25) **In the context of disability issues, which technology feature is essential for enhancing accessibility when using computers?**

- A. Monochrome displays
- B. Voice recognition software
- C. Limited keyboard functionality
- D. Older operating system versions

Answers:

- 1) C. The collection of all the traces and activities someone leaves online
- 2) D. All of the above
- 3) D. All of the above
- 4) B. Respecting others' opinions and responding politely
- 5) C. Delete the email and report it to your email provider
- 6) B. Keeping your message clear and concise
- 7) C. To safeguard personal information from unauthorized access or disclosure
- 8) C. Individuals have the right to access and control their personal data
- 9) B. Using strong passwords and encryption
- 10) B. Sending emails that appear to be from a legitimate source to steal personal information
- 11) D. Botnet
- 12) B. To encrypt the victim's data and demand payment for the decryption key
- 13) B. Using a VPN (Virtual Private Network)
- 14) B. A security process in which the user provides two different authentication factors to verify themselves
- 15) B. Regularly updating your software and operating system
- 16) B. Malicious software intended to damage or disable computers and computer systems
- 17) B. Trojan Horse

- 18) C. Worm
- 19) C. To recycle and properly dispose of electronic waste to minimize environmental impact
- 20) C. Dismantling electronic devices to recover valuable materials
- 21) B. Contamination of soil and water with toxic substances
- 22) B. To provide legal recognition for electronic transactions
- 23) A. Unauthorized access to computer systems
- 24) A. Providing equal access to computer labs for all students
- 25) B. Voice recognition software

Competency Based Questions

Q 1) Describe a situation where you had to manage your digital footprint. What steps did you take, and what was the outcome?

Answer: In college, I realized that my social media presence could impact job prospects. I reviewed my profiles, adjusted privacy settings, and removed any unprofessional content. Additionally, I started sharing industry-relevant articles and my own projects. As a result, I noticed a more positive response from recruiters during interviews.

Q 2) Give an example of how you maintained netiquette during a heated online discussion.

Answer: During an online class debate, a disagreement arose about a controversial topic. I ensured I responded respectfully by acknowledging the other person's points before presenting my arguments with evidence. This approach kept the discussion productive and helped maintain a respectful tone in the class forum.

Q 3) Have you ever dealt with a cyber troll? How did you handle the situation?

Answer: Yes, I managed a community forum where a user began posting inflammatory comments. I addressed the issue by enforcing the community guidelines, warning the user, and eventually banning them after repeated offenses. This action maintained a positive environment for other users.

Q 4) Can you describe an instance where you implemented data protection measures in a project?

Answer: In my previous job, I led a project to handle customer data. I ensured we used encryption for sensitive information, implemented access controls, and conducted regular audits. These measures helped protect our data from breaches, and we successfully passed an external security audit.

Q 5) How did you respond to a potential cyber crime threat in your organization?

Answer: When our company received a phishing email targeting employees, I immediately informed the IT department and communicated the threat to all staff. We conducted a training session on recognizing phishing attempts, which significantly reduced the number of successful phishing incidents.

Q 6) What strategies have you used to promote cyber safety awareness?

Answer: I organized a series of workshops covering topics like password security, recognizing phishing, and safe browsing habits. Additionally, I created an intranet page with resources and tips on cyber safety, which helped increase employee awareness and reduce security incidents.

Q 7) Describe a time when you had to deal with a malware infection. What was your approach?

Answer: Our office network was once infected with malware, causing several computers to malfunction. I isolated the affected systems, ran antivirus scans to remove the malware, and restored data from backups. Post-incident, we updated our security software and implemented stricter email filtering to prevent future attacks.

Q 8) How have you contributed to e-waste management in your organization?

Answer: I initiated an e-waste recycling program where employees could safely dispose of old electronics. We partnered with a certified e-waste recycler and organized quarterly collection drives. This initiative not only reduced our environmental footprint but also raised awareness about e-waste management.

Q 9) Can you provide an example of how you ensured compliance with the IT Act in a project?

Answer: While developing an e-commerce platform, I ensured our data collection practices complied with the IT Act by obtaining user consent and securely storing data. We also implemented measures to protect against cyber crimes, such as encryption and regular security audits, which helped us maintain compliance and protect user data.

Q 10) How have you adapted your teaching methods to accommodate students with disabilities?

Answer: In my computer classes, I used screen readers for visually impaired students and provided keyboard shortcuts for those with motor disabilities. I also ensured that all course materials were accessible and offered one-on-one support to address individual needs. These adaptations helped all students fully participate and succeed in the course.

Very Short Answer Questions

Q 1) What is a digital footprint?

Answer: A digital footprint is the trail of data one leaves online through activities like social media posts and website visits.

Q 2) Why is netiquette important?

Answer: Netiquette ensures respectful and effective communication online.

Q 3) Who are cyber trolls?

Answer: Cyber trolls are individuals who provoke or harass others online to cause disruption.

Q 4) What is the purpose of data protection?

Answer: Data protection safeguards personal and sensitive information from unauthorized access and breaches.

Q 5) What is phishing?

Answer: Phishing is a cyber crime where attackers deceive individuals into providing sensitive information.

Q 6) How can you enhance cyber safety?

Answer: Enhance cyber safety by using strong passwords and enabling two-factor authentication.

Q 7) What is malware?

Answer: Malware is malicious software designed to harm or exploit computer systems.

Q 8) Why is proper e-waste disposal important?

Answer: Proper e-waste disposal prevents environmental pollution and health hazards.

Q 9) What does the IT Act regulate?

Answer: The IT Act regulates electronic commerce, cyber crimes, and digital signatures in India.

Q 10) How can educators support students with disabilities in computer classes?

Answer: Educators can support students with disabilities by providing accessible technologies and personalized accommodations.

Short Answer Questions:

Q 1: How can individuals manage their digital footprints effectively?

Answer: Individuals can manage their digital footprints by being mindful of what they share online, using privacy settings on social media platforms, regularly reviewing and deleting unnecessary data, and considering the long-term implications of their online activities on their digital reputation.

Q 2: What are the potential consequences of leaving a large digital footprint?

Answer: A large digital footprint can lead to privacy concerns, identity theft, targeted advertising, and reputational damage. Employers, universities, and even individuals may use digital footprints to form opinions or make decisions about someone, highlighting the importance of managing online presence carefully.

Q 3: Why is it important to avoid spreading misinformation or rumours online?

Answer: Spreading misinformation or rumours online can harm reputations, create confusion, and contribute to societal distrust. Adhering to net etiquette involves verifying information before sharing it and promoting constructive dialogue rather than spreading falsehoods.

Q 4: How can netiquette contribute to a positive online community?

Answer: Netiquette fosters respectful communication, encourages active listening, and promotes empathy online. By following netiquette guidelines, individuals contribute to a supportive and inclusive online environment where diverse opinions can be shared respectfully.

Q 5: What are cyber trolls, and how do they impact online communities?

Answer: Cyber trolls are individuals who deliberately provoke or harass others online through inflammatory comments, insults, or disruptive behaviour. They can create toxic environments, discourage healthy discourse, and even cause psychological harm to their targets.

Q 6: How can online platforms mitigate the impact of cyber trolls?

Answer: Online platforms can mitigate the impact of cyber trolls by implementing strict community guidelines, encouraging positive interactions, providing reporting and blocking tools, and fostering a culture where respectful communication is valued and rewarded.

Q 7: What are some best practices for organizations to ensure data protection?

Answer: Organizations can ensure data protection by implementing encryption for sensitive data, conducting regular security audits, training employees on data security protocols, obtaining user consent for data collection, and complying with data protection regulations such as GDPR or CCPA.

Q 8: How can individuals protect their data while using public Wi-Fi networks?

Answer: Individuals can protect their data on public Wi-Fi networks by using virtual private networks (VPNs), ensuring websites use HTTPS encryption, avoiding accessing sensitive information, and turning off sharing settings on their devices.

Q 9: What are the steps individuals should take if they become victims of cyber crime?

Answer: If individuals become victims of cyber crime, they should report the incident to law enforcement or cyber crime authorities, preserve evidence such as screenshots or email communications, notify their bank or financial institutions if financial fraud is involved, and take steps to secure their accounts and devices.

Q 10: How can businesses prevent cyber crimes like ransomware attacks?

Answer: Businesses can prevent ransomware attacks by regularly backing up data, educating employees about phishing and suspicious links, updating software and security patches promptly, implementing strong access controls, and considering cyber insurance to mitigate financial losses.

Q 11: What are the common signs that indicate a device may be infected with malware?

Answer: Common signs of malware infection include slow performance, unexpected pop-up windows, changes in browser settings, unusual network activity, and unauthorized access to personal information. Prompt action is essential to mitigate further damage.

Q 12: How can parents ensure their children practice cyber safety while using the internet?

Answer: Parents can ensure their children practice cyber safety by setting parental controls on devices and internet browsers, discussing safe online behaviour and potential risks, monitoring their children's online activities, and encouraging open communication about any concerns or incidents.

Q 13: What are the main sources of malware distribution?

Answer: Malware can be distributed through malicious websites, infected email attachments, software downloads from untrusted sources, removable storage devices like USB drives, and compromised advertisements (malvertising) on legitimate websites.

Q 14: How does ransomware differ from other types of malware?

Answer: Ransomware is a type of malware that encrypts a victim's files or locks them out of their device until a ransom is paid. Unlike other malware that may aim to steal data or disrupt operations, ransomware directly extorts money from victims in exchange for restoring access to their files or devices.

Q 15: Why is improper disposal of e-waste harmful to the environment?

Answer: Improper disposal of e-waste can lead to toxic substances such as lead, mercury, and cadmium leaching into soil and water sources, posing health risks to humans and wildlife. Recycling e-waste responsibly helps recover valuable materials and reduces environmental pollution.

Q 16: How can consumers contribute to responsible e-waste management?

Answer: Consumers can contribute to responsible e-waste management by recycling old electronics through certified e-waste recycling programs, donating functional devices to charity or refurbishment programs, and advocating for sustainable practices among manufacturers and policymakers.

Q 17: What are the key provisions of the Information Technology Act related to cyber crime and electronic signatures?

Answer: The Information Technology Act includes provisions for defining cyber crimes, specifying penalties for offenses such as hacking and data theft, facilitating electronic commerce through legal recognition of electronic records and digital signatures, and establishing adjudicating authorities for cyber disputes.

Q 18: How does the IT Act support electronic governance in India?

Answer: The IT Act promotes electronic governance by enabling the government to issue notifications, licenses, and permits electronically, recognizing electronic documents and digital signatures as legally valid, and ensuring secure electronic transactions through digital certificates and encryption standards.

Q 19: Why is it important to address gender stereotypes in technology education?

Answer: Addressing gender stereotypes in technology education promotes inclusivity, encourages more girls and women to pursue careers in STEM fields, and fosters diverse perspectives in innovation and problem-solving.

Q 20: How can educators accommodate students with disabilities in computer-based learning environments?

Answer: Educators can accommodate students with disabilities by providing accessible digital resources and technologies, using assistive technologies such as screen readers and speech recognition software, ensuring physical accessibility to computer labs and devices, and offering personalized support and accommodations based on individual needs.

Long Questions

Q 1) In today's digital age, maintaining a positive digital footprint is crucial for personal and professional success. Can you discuss the steps one should take to audit and manage their digital footprint effectively, and provide examples of the potential impacts of a poorly managed digital footprint on career opportunities?

Answer: To audit and manage a digital footprint effectively, individuals should start by searching their name on search engines to identify publicly available information. This includes social media profiles, blogs, articles, and any other online activity. Reviewing and cleaning up social media profiles is essential; this involves deleting or privatizing old posts that may be inappropriate or unprofessional. Setting strict privacy settings on social media platforms to control who can view personal information is also crucial.

Individuals should consider what they share online, ensuring it's positive and professional. Creating and maintaining a LinkedIn profile and other professional networking sites can enhance one's digital footprint. Additionally, contributing positively to online communities, such as forums related to one's field, and publishing professional content, such as blog posts or articles, can further build a positive online presence.

A poorly managed digital footprint can significantly impact career opportunities. For example, unprofessional or controversial posts can deter potential employers who often search candidates'

online presence before making hiring decisions. Negative or inappropriate content can damage one's reputation, leading to missed job opportunities or professional relationships. Conversely, a well-managed digital footprint can enhance credibility and present one as a knowledgeable and responsible individual, leading to better career prospects and professional networking opportunities.

Q 2) Cyber trolling can significantly impact individuals and online communities. Explain the psychological effects of cyber trolling on victims and discuss effective strategies that individuals and online platforms can implement to combat cyber trolling.

Answer: Cyber trolling involves sending hostile, offensive, or inflammatory messages to provoke or harass individuals online. The psychological effects on victims can be severe, including stress, anxiety, depression, and decreased self-esteem. Victims may also experience feelings of isolation and helplessness, impacting their personal and professional lives.

To combat cyber trolling, individuals can use several strategies. First, they should avoid engaging with trolls, as responding can escalate the situation. Instead, they can use blocking and reporting features on social media platforms to remove and report trolls. Maintaining a support network of friends and family can provide emotional support and advice.

Online platforms play a crucial role in addressing cyber trolling. Implementing strict community guidelines that prohibit abusive behavior is essential. Platforms can use automated tools to detect and filter out offensive content and provide users with easy ways to report harassment. Ensuring timely and appropriate actions against reported trolls, such as account suspension or banning, can deter such behavior. Educating users about the impact of cyber trolling and promoting a positive online culture can further help in creating a safer online environment.

Q 3) Cyber crime is a growing threat to individuals and organizations. Describe the various types of cyber crimes and discuss a high-profile cyber crime case, detailing the attack method, impact, and the response by the affected organization.

Answer: Cyber crimes encompass a range of illegal activities conducted through digital means. Common types include phishing (fraudulent attempts to obtain sensitive information), hacking (unauthorized access to computer systems), ransomware (encrypting data and demanding payment for its release), identity theft (stealing personal information to commit fraud), and DDoS attacks (disrupting services by overwhelming servers with traffic).

A high-profile cyber crime case is the 2017 Equifax data breach. Attackers exploited a vulnerability in the company's web application to access sensitive data, including Social Security numbers, birth dates, and addresses of approximately 147 million individuals. The impact was significant, leading to identity theft and financial fraud risks for affected individuals. Equifax's response included offering free credit monitoring services to victims, investing in improved security measures, and facing legal and financial repercussions, including fines and settlements. The case highlighted the importance of timely security updates and robust data protection practices.

Q 4) In the context of increasing cyber threats, discuss the importance of cyber safety education for individuals and organizations. Provide examples of effective cyber safety practices that can be adopted to protect against online threats.

Answer: Cyber safety education is crucial for raising awareness about online threats and promoting safe behaviors to protect personal and organizational data. Educated individuals are less likely to fall

victim to phishing scams, malware, and other cyber attacks, while organizations can enhance their overall security posture.

Effective cyber safety practices include using strong, unique passwords for different accounts and enabling two-factor authentication to add an extra layer of security. Regularly updating software and operating systems to patch vulnerabilities is essential. Individuals should be cautious about sharing personal information online and verify the legitimacy of websites and emails before providing sensitive data.

For organizations, implementing comprehensive cybersecurity policies, conducting regular security audits, and providing ongoing training to employees on recognizing and responding to cyber threats are effective practices. Additionally, using advanced security technologies such as firewalls, intrusion detection systems, and endpoint protection can help safeguard against cyber attacks.

Q 5) Malware poses a significant risk to computer systems and data integrity. Explain the different types of malware and describe a real-world example of a malware attack, including how it was detected, the damage caused, and the remediation steps taken.

Answer: Malware includes various malicious software types, such as viruses (self-replicating programs that infect files), worms (self-replicating programs that spread across networks), ransomware (encrypts data and demands ransom), spyware (secretly monitors user activity), and trojans (disguised as legitimate software to gain access).

A real-world example is the WannaCry ransomware attack in 2017. It exploited a vulnerability in Windows operating systems, spreading rapidly and encrypting files on infected computers. The attack caused widespread disruption, affecting hospitals, businesses, and government agencies worldwide. Detection occurred through reports of encrypted files and ransom demands.

The damage included significant operational disruptions, data loss, and financial losses due to ransom payments and recovery efforts. Remediation steps involved applying security patches to close the exploited vulnerability, restoring data from backups, and implementing improved cybersecurity measures to prevent future attacks. The attack underscored the importance of timely software updates and robust data backup practices.

Case Study Questions

Q 1) Sarah is a college student who regularly posts updates about her personal life on social media. Recently, she discovered that potential employers have been viewing her social media profiles during job interviews. How can Sarah manage her digital footprint to enhance her professional image?

Answer: Sarah can manage her digital footprint by adjusting her privacy settings on social media platforms to limit who can view her posts. She should also review and delete any content that may be perceived negatively by employers. Additionally, she can create a professional online presence by sharing relevant achievements and interests related to her career goals, which can overshadow less professional content.

Q 2) Tom is participating in an online discussion forum where he disagrees with another member's viewpoint. How should Tom express his disagreement respectfully and contribute positively to the discussion?

Answer: Tom should express his disagreement respectfully by focusing on the content of the discussion rather than attacking the person's character. He can start by acknowledging the valid points made by the other member before presenting his counterarguments with supporting evidence or examples. It's important for Tom to use polite language, avoid personal attacks, and be open to considering different perspectives to maintain a constructive dialogue.

Q 3) Emma runs a popular blog where she frequently receives derogatory comments and personal attacks from anonymous users. How can Emma effectively deal with cyber trolls while maintaining a positive online presence?

Answer: Emma can effectively deal with cyber trolls by implementing comment moderation on her blog to filter out offensive or inappropriate comments. She should establish clear community guidelines that discourage trolling behavior and encourage constructive feedback. Emma can also empower her audience to report abusive comments and consider blocking persistent offenders to maintain a safe and supportive online environment.

Q 4) Mark works for a financial services company that recently experienced a data breach compromising customer information. How should Mark and his company respond to mitigate the impact of the breach and ensure data protection in the future?

Answer: Mark and his company should respond to the data breach by immediately notifying affected customers and regulatory authorities as required by data protection laws. They should conduct a thorough investigation to determine the cause of the breach and implement enhanced security measures such as encryption, multi-factor authentication, and regular security audits. Mark should also provide affected customers with support and resources to protect their identities and financial information.

Q 5) Laura's online banking account was hacked, and unauthorized transactions were made using her credit card information. How should Laura respond to this cyber crime incident to minimize financial loss and prevent future attacks?

Answer: Laura should respond to the cyber crime incident by immediately contacting her bank to report the unauthorized transactions and freeze her account if necessary. She should also change her online banking passwords and monitor her financial statements for any further suspicious activity. Laura should file a police report and keep records of all communications with her bank and law enforcement for documentation purposes. To prevent future attacks, she should enable two-factor authentication on her accounts and remain vigilant about phishing scams and malware threats.

Q 6) James received an email with an attachment from an unknown sender claiming to be a job offer. How should James handle this situation to ensure his cyber safety?

Answer: James should handle the situation by not opening the email attachment or clicking on any links within the email, as it could potentially contain malware or phishing attempts. He should delete the email immediately and mark it as spam. James should verify job offers through official channels or directly contact the company's HR department using verified contact information to confirm the legitimacy of the email. Practicing caution and skepticism with unsolicited emails can help James protect his personal information and avoid falling victim to cyber threats.

Q 7) Maria's computer suddenly started running slower than usual, and she noticed unexpected pop-up windows appearing on her screen. What steps should Maria take to identify and remove malware from her computer?

Answer: Maria should first disconnect her computer from the internet to prevent further damage and then run a full system scan using reputable antivirus software. She should follow the software's instructions to quarantine or remove any detected malware. Maria should also update her operating system and software applications to their latest versions, as updates often include security patches that can protect against known vulnerabilities exploited by malware. Regularly backing up important files can help Maria recover her data in case of a malware attack.

Q 8) David's company recently upgraded its office computers and is unsure how to responsibly dispose of the old equipment. What steps should David take to ensure proper e-waste management?

Answer: David should ensure proper e-waste management by partnering with certified e-waste recycling vendors that adhere to environmental regulations and ethical recycling practices. He should inquire about the vendor's recycling processes to ensure that electronic components are properly dismantled, recycled, or disposed of in an environmentally friendly manner. David can also explore options for refurbishing or donating functional equipment to charitable organizations or schools, promoting sustainability and reducing electronic waste generation.

Q 9) Sarah operates an e-commerce website that collects customer data for processing orders. What legal obligations does Sarah have under the Information Technology Act regarding data protection and privacy?

Answer: Sarah has legal obligations under the Information Technology Act to protect customer data by implementing reasonable security practices and procedures to safeguard sensitive information from unauthorized access, disclosure, or misuse. She should obtain customer consent before collecting personal data and clearly communicate her privacy policy detailing how customer information will be used, stored, and protected. Sarah should also comply with data breach notification requirements and cooperate with law enforcement authorities in case of cyber crime incidents involving customer data.

Q 10) In a computer science class, Sarah notices that female students are less likely to participate actively in coding exercises compared to male students. How can Sarah address gender stereotypes and encourage equal participation among all students?

Answer: Sarah can address gender stereotypes by promoting an inclusive learning environment where all students feel valued and encouraged to participate. She can incorporate diverse examples and role models in her teaching materials to demonstrate that computer science is accessible and relevant to everyone, regardless of gender. Sarah should actively encourage female students to share their ideas and collaborate with peers, provide constructive feedback, and recognize their achievements to boost confidence and engagement. By fostering a supportive classroom culture that celebrates diversity and inclusivity, Sarah can help bridge gender gaps and empower all students to succeed in computer science education.

10	Which one of the following in correct ascending order of size for nibble, byte, kb, bit, mb a) bit<byte<nibble<mb<kb b) nibble<byte<bit<kb<mb c) bit<byte<nibble<kb<mb d) bit<nibble<byte<kb<mb	1
11	_____ is a system software that translates and executes instructions written in a computer program line-by-line. a) Assembler b) Interpreter c) Compiler d) None of these	1
12	Which encoding scheme has code points for all the known languages a) ASCII b) Unicode c) ISCII d) none of these	1
13	$(3984.75)_{10} = ()_{16}$ a) F90.C b) 9F.4B c) F90.4B d) 9F.C	1
14	Unlawfully gaining sensitive information of someone by posing as genuine entity a) Spamming b) Hacking c) Cracking d) Phishing	1
15	Gaining an unauthorized access is called _____ a) Spamming b) Hacking c) Cracking d) Phishing	1
16	A program which appears safe and genuine but actually is not a) Spyware b) Worm c) Trojan d) Adware	1
	Q 17 and 18 are ASSERTION AND REASONING based questions. Mark the correct choice as a) Both A and R are true and R is the correct explanation for A b) Both A and R are true and R is not the correct explanation for A c) A is True but R is False d) A is False but R is True	
17	if 7: print("True") else: print("False") Assertion (A): Output of the above code is False Reasoning (R): Non-empty and Non-Zero object is treated as True.	1
18	d={1:11, 2:22, 3:33} print(11 in d) Assertion (A): Output of above code is False. Reasoning (R): Membership operator does not check for values in a dictionary but only for keys.	1
<u>SECTION B</u>		
19	Write a python program which reads string from user and count the number of vowels present in it. OR Draw flowchart to print multiplication table of any given number(say n).	2

20	Draw logic circuit for following Boolean expressions: (i) $AB' + B(A+C)$ (ii) $(AB+BC)(AC)$	2
21	Correct and rewrite the following code underlining all the corrections. <pre>x=int(input("Enter speed")) if x>120 print("Vehicle impounded") else x=>80: print("Fine 2000 Rs.) else: print("Good to go")</pre> <p style="text-align: center;">OR</p> <p>Write output of the following code: <pre>x=1531 s=0 while x>0: a=x%10 s=s+a x=x//10 print(s)</pre></p>	2
22	What is output of the following code: <pre>x=5 y=(5) print(type(x)) print(type(y))</pre>	2
23	In the following code check where is the error and when will that error occur during compile time or run time <pre>a=int(input("Enter first number")) #statement 1 b=0 #statement 2 c=a/b #statement 3 print(c) #statement 4</pre>	1+1=2
24	What is Plagiarism? Write two ways to avoid it. <p style="text-align: center;">OR</p> Write two net etiquettes.	2
25	Write at least two ways of e-waste management.	2
<u>SECTION C</u>		
26	Predict the output of the Python code given below: <pre>text = "Alm19hty!" new = " count = 0 for i in text: if text[count]>='0' and text[count]<='9':</pre>	3

	<pre> new+=str(int(text[count])+1) elif text[count]>='A' and text[count]>='Z': new+=text[count].lower() elif text[count]>='a' and text[count]>='z': new+=str(count) else: new+='*' count+=1 print(new) </pre>	
27	What is OS? Write its any two functions.	3
28	<p>Write output of the following Python code:</p> <pre> P=[1,6,9,3,8,3,1,7,3,9,1] Q=[2,3,7,9,5,3,5,9] R=[] for i in P: if i in Q and i not in R: R.append(i) print(R) </pre> <p style="text-align: center;">OR</p> <p>Write output of the following Python code:</p> <pre> P=[1,6,9,3,8,3,1,7,3,9,1] Q=[2,3,7,9,5,3,5,9] R=[] for i in P: if i not in Q and i not in R: R.append(i) print(R) </pre>	3
29	Explain Cyber bullying with the help of Examples.	3
30	<p>A person was surfing the web and a particular website showed him his OS and browser name. After which he submitted his name and phone number for a lottery on that website. What is this type of data called which was collected by the website? This is type of data is classified into two types. Out of these two the following data falls under which:</p> <p>(i) Name of OS and browser</p> <p>(ii) Name and phone number of the person</p>	3
<u>SECTION D</u>		
31	<p>Dharamveer a Python programmer is working on a mathematical project and tried creating a code for it. Suggest him a module and function from that module which can be used for the following tasks</p> <p>(i) To calculate absolute value of a number.</p> <p>(ii) To calculate mean from a list of marks.</p> <p>(iii) To generate a random number between 1 to 6 (both values included).</p>	1*4=4

	(iv) To generate a random number between 0(included) and 1(excluded).	
32	Amit made a friend online whom he doesn't know in real life and has never met. After some time, he started posting demeaning statements about him. (i) What is happening to Amit? (ii) What action should he take? (iii) Which law in India addresses this activity? (iv) What steps should be followed to avoid this kind of activity?	4
<u>SECTION E</u>		
33	a) Write output for the following s = "Incredible India" (i) print(s[:5:]) (ii) print(s[9:-9:-1]) (iii) print(s[5:-2:1]) (iv) print(s[::-1]) b) Write a Python program to get a year from user and print whether it is a leap year or not. (Leap year is a non century year divisible by 4 eg. 1984, a century year divisible by 400 eg 1600)	2+3=5
34	Mihir took part in a Code Challenge and was presented with following incomplete codes with problem statement each. Help Mihir to win the Code Challenge (i) Write code for Fibonacci Series where every next term is sum of previous two terms f=0 s=1 print(f) print(_____) #Statement-1 for i in range(10): t= _____ #Statement-2 print(t) f=s s=_____ #Statement-3 (ii) Complete the code to calculate sum of digits of a number n=input("Enter a number :") s=_____ #Statement-1 for i in n: s= _____ #Statement-2	3+2=5
35	(i) Complete the following code for calculating factorial of a number n = int(input("Enter a number :")) f= _____ #Statement-1 for i in range(1,_____,1): #Statement-2 f=f*i print('factorial is', f) (ii) What will be the output of the following code d1={1:10,2:20,3:30,4:40} d2={5:50,6:60,7:70}	2+3=5

	<pre>d1.update(d2) print(d1) print(d2.get(3)) print(d2.popitem())</pre> <p style="text-align: center;">OR</p> <p>(i) Complete the following code to compute the sum of first n natural numbers</p> <pre>n = int(input("Enter a number :")) s= _____ #Statement-1 for i in range(n): s=_____ #Statement-2 print('Sum is', s)</pre> <p>(ii) Perform following operations on a dictionary using dictionary methods only: d = {1: 'one', 2: 'two', 3 : 'three' }</p> <p>(a) Add a key 5 with value 'five'</p> <p>(b) Remove the key value pair for key 2</p> <p>(c) Print value at key 3</p>	
--	--	--

Answers

SECTION - A		
Q. No	Question	Marks
1	b) rectangle	1
2	c) expression	1
3	c) 516	1
4	c) '[1,2,3]'	1
5	False	1
6	a) NAND	1
7	b) Identity Theft	1
8	d) {3:3} * 3	1
9	c) Statement 3	1
10	d) bit<nibble<byte<kb<mb	1
11	b) Interpreter	1
12	b) Unicode	1
13	a) F90.C	1
14	d) Phishing	1
15	b) Hacking	1
16	c) Trojan	1
17	d) A is False but R is True	1
18	a) Both A and R are true and R is the correct explanation for A	1
<u>SECTION B</u>		
19	2 marks for correct python program OR 2 marks for correct flowchart	2

20

1 mark each for any correct circuit

2

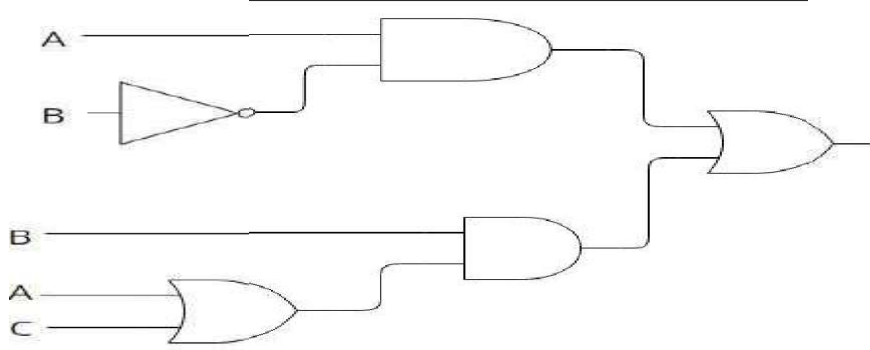
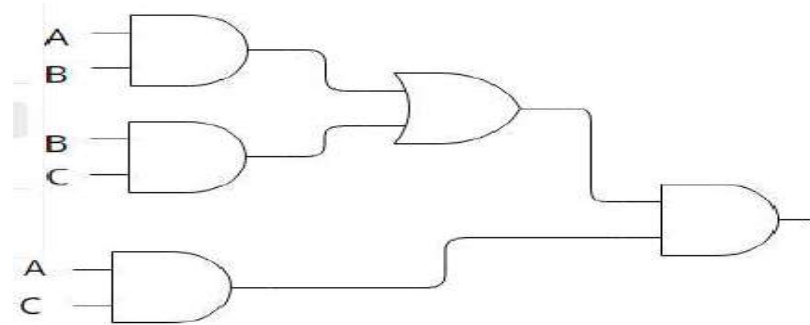
(i) $AB' + B(A+C)$ (ii) $(AB+BC)(AC)$ 

21	<p><i>½ mark for each correction</i></p> <pre>x=int(input("Enter speed")) if x>120: print("Vehicle impounded") else x>=80: print("Fine 2000 Rs.") else: print("Good to go")</pre> <p style="text-align: center;">OR</p> <p><i>½ mark for each correct output</i></p> <p>1 4 9 10</p>	2
22	<p><i>1 mark for each correct output</i></p> <pre><class 'int'> <class 'int'></pre>	2
23	<p><i>1 mark for each</i></p> <pre>a=int(input("Enter first number")) #statement 1) missing ompile time error c=a/b #statement 3 ZeroDivisionError run time</pre>	1+1=2
24	<p><i>1 mark for definition, ½ mark for each way to avoid</i></p> <p>Presenting someoneelse’s idea or work as one’s own idea or work is calledplagiarism. Two ways to avoid are:</p> <p>(i) Use original or creative ideas (ii) Give credit to the owner</p> <p style="text-align: center;">OR</p> <p><i>2 mark for any two etiquettes</i></p> <p>(i) Be responsible (ii) Be ethical (iii) Be respectful</p>	2
25	<p><i>2 mark for any two ways</i></p> <p>Two ways of e-waste management.</p> <p>(i) Reduce (ii) Reuse (iii) Recycle</p>	2

<u>SECTION C</u>		
26	3 marks for correct output, partial marking for partially correct *lm210hty*	3
27	1 mark for definition and 1 mark for each function Operating System is a system software that operates the computer. An operating system is the most basic system software, without which other software cannot work. Its two functions: (i) Process management (ii) Memory management	3
28	1 mark for each correct number [9, 3, 7] OR 1 mark for each correct number [1, 6, 8]	3
29	1 mark for correct definition of cyber bullying 2 mark for correct examples	3
30	1 mark for each Digital footprint (i) Passive Digital footprint : Name of OS and browser (ii) Active Digital footprint : Name and phone number of the person	3
<u>SECTION D</u>		
31	(i) <code>math.fabs()</code> (ii) <code>statistics.mean()</code> (iii) <code>random.randint(1,6)</code> or <code>random.randrange(1,7)</code> (iv) <code>random.random()</code>	1*4=4
32	1 mark for each (i) cyber bullying (ii) inform parents, school authority and police (iii) IT Act (iv) do not befriend strangers	4

SECTION E		
33	<p>a) $\frac{1}{2}$ mark for each</p> <p>(i) Incre (ii) el (iii) dible Ind (iv) aidnI elbidercni</p> <p>b) <i>partial marking for partially correct code</i> <code>y=int(input())</code> <code>if y%400==0 or (y%100!=0 and y%4==0):</code> <code> print("Leap year")</code> <code>else:</code> <code> print("Not a Leap year")</code></p>	2+3=5
34	<p>(i) 1 mark for each correct statement</p> <code>print(f,s) #Statement-1</code> <code>t=f+s #Statement-2</code> <code>s=t #Statement-3</code> <p>(ii) 1 mark for each correct statement</p> <code>s=0#Statement-1</code> <code>s= s+ int(i) #Statement-2</code>	3+2=5
35	<p>(i) 1 mark for each correct statement</p> <code>f=1 #Statement-1</code> <code>for i in range(1,_n+1__,1): #Statement-2</code> <p>(ii) 1 mark for each correct output</p> <p>{1: 10, 2: 20, 3: 30, 4: 40, 5: 50, 6: 60, 7: 70} None (7, 70)</p> <p style="text-align: center;">OR</p> <p>(i) 1 mark for each correct statement</p> <code>s=0 #Statement-1</code> <code>s=s+i #Statement-2</code> <p>(ii) 1 mark for each correct statement</p> <p>(a) <code>d.setdefault(5,'five')</code> (b) <code>d.pop(2)</code> (c) <code>d.get(3)</code></p>	2+3=5

UNSOLVED SAMPLE PAPER – 1

Max Marks: 70

Time:3 hrs.

General Instructions:

- Please check this question paper contains 35 questions.
- The paper is divided into 5 Sections- A, B, C, D and E.
- Section A, consists of 18 questions (1 to 18). Each question carries 1 Mark.
- Section B, consists of 7 questions (19 to 25). Each question carries 2 Marks.
- Section C, consists of 5 questions (26 to 30). Each question carries 3 Marks.
- Section D, consists of 2 questions (31 to 32). Each question carries 4 Marks.
- Section E, consists of 3 questions (33 to 35). Each question carries 5 Marks.
- All programming questions are to be answered using Python Language only.

	Question	Marks
<u>SECTION A</u>		
1	Amit Study about the system tool disk fragment he tried this application for drive D: but he is unable to understand the category of software - a)Operating System b). System Software c). Utility Program d). None of these	1
2	The hexadecimal digits are 1 to 0 and A to _____ a) E b). F c). G d). D	1
3	The output of a two-input AND gate is high when a)Both inputs are low b) Both inputs are high c) Any one input is high d). Only one input is high	1
4	Ms Silky Stealing someone else’s intellectual work and representing it as own, this type of crime is called- a)Intellectual steal b). Pluckism c). Plagiarism d). Pickism	1
5	Ms Sonakshi Procure a New Computer but could not install Firewalls. Suggest her use of firewall and to protect against- a)Data driven attacks b) Fire attacks c) Virus attacks d). Unauthorized access	1
6	Ms Ankita is student of Class XI and study about various types of cybercrime committed by people. Help her to identify, which of the following is not a cyber-crime? a. Identity theft b. Sending mail to misspelled email id c. Cyber Bullying d. Cyber Stalking	1
7	The cookies are stored on user’s computer locally. a)True b). False	1
8	What shape represents a decision in a flowchart? a)A diamond b) A rectangle c). An oval d). None of these	1
9	Ms Suman is Computer science teachers in kits World public School Pitampura Delhi, While teaching of language processor he raised as question Python uses a/an _____ to convert source code to object code. a. Interpreter b. Compiler c. Combination of Interpreter and Compiler d. Special virtual engine	1
10	Which of the following is an escape sequence for a new line character? a. \a b). \t c) \n d) \b	1

11	Mr Somil assigned the values to python variable, What will be the following code produce? A , B = 8.6 , 2 print(A//B) a)4.3 b). 4.0 c). 4 d) Compilation error	1
12	Which of the following statements will make a selection construct? a)if b). if-else c) for d) while	1
13	Ms. Asha develop program of application of operator but she was confused amongst the operator available, Suggest her Which of the following is/are not legal string operators? a)in b) + c) * d) /	1
14	Which of the following will return the last element of a list L with 5 elements? a. L[5] b) L[-4] c) L[-1] d) L[6]	1
15	Which of the following will create a single element tuple? a. (1,) b) (1) c) ([1]) d) None of these	1
16	Dictionaries are also called- a. Mappings b) Hashes c) Associative arrays d) All of these	1
<p>Q17 and 18 are ASSERTION AND REASONING based questions. Mark the correct choice as</p> <p>a. Both A and R are true and R is the correct explanation for A</p> <p>b. Both A and R are true and R is not the correct explanation for A</p> <p>c. A is True but R is False</p> <p>d. A is false but R is True</p>		
17	Assertion (A): Strings in Python are mutable. Reason (R): The first character has the index 0 and the last character has the index n-1 where n is the length of the string.	1
18	Assertion: The for loop is a counting loop that works with sequences of values. Reason: The range() function generates a sequence of list type.	1
SECTION B		
19	What is the difference between RAM and ROM? <i>Or</i> Name the input or output device to do the following- a. To output audio b. To enter textual data c. To make hard copy of a text file. d. To display the data or information	1+1=2
20	Mr Harpreet is children with special need while using the computer he faced difficulty how you can Explain gender and disability issues briefly while teaching and using computers.	2
21	Write a program to input two numbers and swap them. <i>Or</i> Write a program to input a number and print its cube and also print original number.	2
22	Ms Anshika is continuously received messages on her phone and finally becomes victims of Phishing. What should she will do, if she has already responded to a phishing e-mail and fear I may be victim of identity theft ?	2
23	a)What is the output produced when this code executes?	1+1=2

	<pre> A = 0 for I in range (4, 8): if I % 2 == 0: A = A + I print (A) </pre> <p>b)How many times does the following code execute?</p> <pre> X = 1 while (X <= 5): X+1 print(X) </pre> <p style="text-align: center;">Or</p> <p>What does each of the following expressions evaluates to? Suppose that L is the list ["These", ["are", "a"], ["few", "words"], "that", "we", "will", "use"]</p> <p>a. len(L) b. L[3 : 4] + L[1 : 2]</p>	
24	<p>Ms Nancy Sehgal is a program developer and writing below code, while running the code she was getting errors. Find the errors and correct it, rewrite the program after underlining the corrected code.</p> <pre> Tup = eval(enter("input a tuple")) Ln = length(Tup) Num = Tup.Count(Tup[0]) if Num = Ln : print("Tuple contains all the same elements.") else : print("Tuple contains different elements.") </pre> <p style="text-align: center;">Or</p> <p>Mr Piyush Gupta is python program analysist and assigned as a program to create a dictionary M which stores the marks of the students of class with roll numbers as the keys and marks as the values. Get the number of students as input.</p>	2
25	<p>Mr Suryakant is Software developer designing a software for Megatel Pvt Ltd. Before coding he requires to develop Pseudocode and flowchart help him to suggest way of writing Pseudocode and flowcharts.</p>	2
SECTION C		
26	<p>What will be the output displayed at Line3, Line 5 and Line 7 of following Python code:</p> <pre> data = [2,5,6,2,7,5,2,9,11,18,2,4] val = data.pop() print(val) # Line 3 data.extend([100,200]) print(len(data)) # Line 5 c = data.count(2) print(c) # Line 7 </pre>	3
27	<p>Preeti celebrated her birthday with her family. She was excited to share the</p>	1*3=3

	<p>moments with her friend Himanshu. She uploaded selected images of her birthday party on social networking site so that Himanshu can see them. After few days, Preeti had a fight with Himanshu. Next morning, she deleted her birthday photographs from that social networking site, so that Himanshu cannot access them. Later in the evening, to her surprise, she saw that one of the images which she had already deleted from the social networking site was available with their common friend Gayatri. She hurriedly enquired Gayatri "Where did you get this picture from?". Gayatri replied "Himanshu forwarded this image few minutes back".</p> <p>Help Preeti to get answers for the following questions. Give justification for your answers so that Preeti can understand it clearly.</p> <ol style="list-style-type: none"> How could Himanshu access an image which I had already deleted? Can anybody else also access these deleted images? Had these images not been deleted from my digital footprint? 	
<p>28</p>	<p>Ms Anvi is python learner he developed code for small python programs Write the code in python to print the following pattern using nested loop-</p> <pre>12345 1234 123 12 1</pre> <p style="text-align: center;">Or</p> <p>Write code in python to input the value of x and n and print the sum of the following series: $1 + x + x^2 + x^3 + x^4 + x^5 + \dots + x^n$</p>	<p>3</p>
<p>29</p>	<p>Kids Elementary Technologies help nursery children to improve their handwriting and writing skills such as word formation, recognition of lower and uppercase letters and small sentences formation.</p> <p>A program has been written by the programmer that should prompt the child to type some sentence(s) followed by "enter". It should then print the original sentence(s) and the following statistics relating to the sentence(s):</p> <ul style="list-style-type: none"> ->number of words ->number of characters (including white space & punctuation) ->percentage of characters that are alphanumeric. <p>Help the programmer to complete the program, by filling correct statements in the blanks.</p> <pre>s=input("Enter a sentence : ") number_of_words =1 number_of_characters = _____ statement1 p=_____ statement2 al_num=0 for i in s: if _____ : statement3 al_num+=1 print("number of words are : ",number_of_words) print("number of characters are : ",number_of_characters) print("percentage of characters that are alphanumeric is : ",p,"%")</pre> <p>Write statements for the following:</p> <ol style="list-style-type: none"> statement1 – to find the length of the string/sentence input by the user statement2 – to initialize percentage with a suitable value 	<p>1*3=3</p>

	3. statement3 – to check the alphanumeric value											
30	Write a program in python to generate the terms of the Fibonacci series up to nth term. Program should ask the user to enter the value of 'n'. OR Write a program to input a number and generate the mathematical table of that number only if that number is divisible by 2.	3										
SECTION D												
31	<p>Ms Ruchi is working as a Cyber Security Technical Specialist in Delhi Police She was assigned a job to caught criminal offences in different filed of cyber crime. How she can identify the crime to Match the following :</p> <table border="1" style="width: 100%; border-collapse: collapse;"> <thead> <tr style="background-color: #f4a460;"> <th style="width: 30%;">Column A</th> <th>Column B</th> </tr> </thead> <tbody> <tr> <td>(a) Plagiarism</td> <td>(i) Fakers, by offering special rewards or money prize asked for personal information, such as bank account information.</td> </tr> <tr> <td>(b) Hacking</td> <td>(ii) Copy and paste information from the Internet into your report and then organise it.</td> </tr> <tr> <td>(c) Credit card fraud</td> <td>(iii) The trail that is created when a person uses the Internet.</td> </tr> <tr> <td>(d) Digital Foot Print</td> <td>(iv) Breaking into computers to read private emails and other files.</td> </tr> </tbody> </table>	Column A	Column B	(a) Plagiarism	(i) Fakers, by offering special rewards or money prize asked for personal information, such as bank account information.	(b) Hacking	(ii) Copy and paste information from the Internet into your report and then organise it.	(c) Credit card fraud	(iii) The trail that is created when a person uses the Internet.	(d) Digital Foot Print	(iv) Breaking into computers to read private emails and other files.	1*4=4
Column A	Column B											
(a) Plagiarism	(i) Fakers, by offering special rewards or money prize asked for personal information, such as bank account information.											
(b) Hacking	(ii) Copy and paste information from the Internet into your report and then organise it.											
(c) Credit card fraud	(iii) The trail that is created when a person uses the Internet.											
(d) Digital Foot Print	(iv) Breaking into computers to read private emails and other files.											
32	<p>Akshat is a of class XI. He has written a program for manipulating string. Fill the blank with appropriate command / method</p> <pre>myaddress="Wazirpur 1, New Yamuna Nagar, New Delhi" for i in range(_____) #line 1 if myaddress[i].__ : #line 2 print(myaddress[i].upper(), end="") elif myaddress[i].____: # line 3 print("*",end="") else: print(myaddress[i],end="") print() print(len(myaddress.split(","))) #line 4 print(myaddress.replace("New","Old")) #line 5</pre> <p>a. Fill in the blank in Line 1 to calculate length of string b. Write the function in line 2 to check lower letter. c. Write the function in line 3 to check digit. d. What will be the output of line 4.</p> <p>OR</p> <p>d. What will be the output of line 5.</p>	4										
SECTION E												
33	Mr Arvind is software developer and works with infotech Company Ltd Noida. He has assigned to Create a dictionary with the roll number, name and marks of n students in a class and display the names of students who have marks above 75. How he can write the correct python code for the same.	5										
34	Ms Manali is a Assistant Programmer in HCL Technologies in Gurugram. She is studing about the logical circuits and verification of various laws of Boolean Algebra . Give direction to resolve following a. Draw logic circuit diagram for the following expression-	2+3=5										

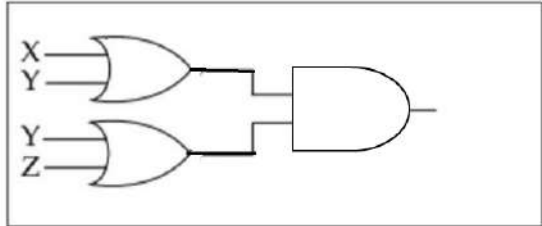
	<p>$Y = ab + \bar{b}c + \bar{c}\bar{a}$</p> <p>b. State De Morgan's Law of Boolean Algebra and verify them using truth table.</p> <p style="text-align: center;">Or</p> <p>a. Write the equivalent Boolean expression for the Logic Circuit.</p> <div style="text-align: center;">  </div> <p>b. Ms Sakshi is a Class XI student and study about the number system and their mutual conversions. Help her to do the following conversions to other number systems –</p> <ol style="list-style-type: none"> i. $(76F)_{16} = (?)_{10}$ ii. $(11001010)_2 = (?)_8$ iii. $(789)_{10} = (?)_{16}$ 	
35	<p>Mr. Monish is trying to develop a program based on list manipulations. He is supposed to add/remove elements in the list, Help him to write the most appropriate list method to perform the following tasks in the list :</p> <p>Name of list is Marks=[10,20,30,40,50,60]</p> <ol style="list-style-type: none"> a) delete an element value 20 from the list. b) get the position of an element 40 in the list c) delete the 3rd element from the list d) add single element 70 at the end of the list e) add another list [80,90,100] at the end of the list. 	5

General Instructions:

This question paper contains five sections, Section A to E.

All questions are compulsory.

Section A have 18 questions carrying 01 mark each.

Section B has 07 Very Short Answer type questions carrying 02 marks each.

Section C has 05 Short Answer type questions carrying 03 marks each.

Section D has 02 questions carrying 04 marks each.

Section E has 03 Long Answer type questions carrying 05 marks each.

All programming questions are to be answered using Python Language only.

Section A (1 mark)	
S. No.	Questions
1	Convert the following from Octal to Binary (3.1) ₈ = _____ Octal to Binary
2	A computer can store Decimal Number System (True/False).
3	Which of the following is/are the universal logic gates? a) OR and NOR b) AND c) NAND and NOR d) NOT
4	An antivirus software protects against (a) VIRUS attack (b) Phishing and pharming (c) Both (a) & (b) (d) None of these
5	Plagiarism means: (a) trolling (b) bullying (c) stalking (d) stealing
6	Cyber crimes are punishable under which Act?
7	An input function always returns a value of _____ type.
8	Which of the following is/are not a valid identifier? a) Mybook b) @book c) _book d) book#
9	A variable can contain values of different types at different times. (True/False).
10	What will be the value of y after following code fragment is executed? x=10.0 y=(x<100.0)and x>=10 (a)110 (b)True (c)False (d)Error
11	Floor division of two integers results in an integer. (True/False)
12	Which of the following statements is true about the if-else statement in programming? A. It can only handle two conditions. B. It can handle multiple conditions. C. It can only be used for numeric comparisons. D. It cannot be nested within another if-else statement.
13	Which loop is appropriate to use when the number of iterations is known? A. for loop B. while loop C. do-while loop D. break loop
14	What is the output of the following Python code ? for i in range(1, 5): if i % 2 == 0: print(i, end= " ") A. 1 B. 2 C. 2 4 D. 1 3
15	In Python, which keyword is used to exit a loop prematurely? A. exit B. stop C. break D. terminate

16	How can you add a new key-value pair to a dictionary? a) dict1.add('d', 4) b) dict1['d'] = 4 c) dict1.append('d', 4) d) dict1.insert('d', 4)
17	How can you check if a string contains only alphabets? a) isalpha() b) isalphabet() c) isletters() d) isalphabets()
18	What is the output of the following code? y = (3) print(type(y)) a) <class 'int'> b) <class 'tuple'> c) <class 'list'> d) <class 'str'>
Section B (2 marks)	
19	What is the need of RAM?How does it differ from ROM?
20	In the following questions, a statement of Assertion(A) is followed by a statement of Reason (R). Mark the correct choice as: a) Both A and R are true and R is the correct explanation of A. b) Both A and R are true but R is not the correct explanation of A. c) A is true but R is false (or partly true). d) A is false (or partly true) but R is true. e) Both A and R are false or not fully true. i. Assertion: Not all types of software are system software. Reason: Application software are designed to carry out operations for a specific application ii. Assertion: The decimal number system has base 10. Reason: The decimal number system is composed of 10 unique symbols.
21	What are Worms and Trojan horses?
22	Scenario: Rahul is working on a group project for his computer science class. One of his teammates submits a section of the project that includes code copied from an open-source project without attribution. The teacher uses a plagiarism detection tool and flags the copied code. Questions: Q1: What should Rahul's team have done to avoid being flagged for plagiarism? A) Written all code by themselves without any external references. B) Used the copied code but provided proper attribution and licensing information. C) Submitted the project without any modifications. D) Claimed the copied code was their own original work. Q2: What is the role of plagiarism detection tools in academic settings? A) To help students complete their work faster. B) To identify and flag instances of copied or unoriginal work. C) To provide automatic citations for students. D) To rewrite copied content in a new way.
23	Write the output of the following num1,num2=2,6 num1, num2=num2, num1+2 print(num1,num2)
24	Write a Python program using a while loop to find the sum of natural numbers up to a given number n.
25	What possible output(s) are expected to be displayed on screen at the time of execution of

	<p>the program from the following code? Also specify the maximum values that can be assigned to each of the variables FROM and TO.</p> <pre>import random AR=[20,30,40,50,60,70] FROM=random.randint(1,3) TO=random.randint(2,4) for K in range(FROM,to+1): print(AR[K],end="#")</pre> <p>a). 10#40#70# b) 30#40#50# c) 50#60#70# d) 40#50#70#</p>
Section C (3 marks)	
26	<p>a) State DeMorgan's Law of Boolean Algebra and verify them using truth table. b) Draw a logic circuit diagram for the Boolean expression: $X=A'BC(A+D)'$</p>
27	<p>Ravi is a high school student who frequently uses social media platforms. Recently, he came across a website offering pirated software for free. Ravi downloaded and installed the software on his computer. After some time, his computer started showing unusual behaviour, such as slow performance and unexpected pop-up ads.</p> <p>Questions:</p> <p>Q1: What ethical issue is Ravi involved in? A) Identity theft B) Software piracy C) Data privacy breach D) Cyberbullying</p> <p>Q2: What could be the possible reason for Ravi's computer's unusual behaviour? A) High internet speed B) Presence of malware in the pirated software C) Overuse of computer resources D) Lack of updates in the operating system</p> <p>Q3: What should Ravi have done instead of downloading pirated software? A) Buy licensed software B) Use free and open-source software C) Both A and B D) Ignore the need for software</p>
28	What are data types? What are Python's built-in core data types?
29	Write a program to check if a given number is a palindrome number or not.
30	Differentiate between append(), extend(), and insert() methods in a list with examples
Section D(4 marks)	
31	<p>Source Text: "Conditional statements in programming allow for decision-making. The if, elif, and else statements in Python help execute code blocks based on certain conditions. Iterative statements, such as for and while loops, enable the repeated execution of a code block until a specific condition is met."</p> <p>Questions:</p> <p>Q1: According to the source, what is the purpose of conditional statements in Python? A) To repeat a block of code multiple times B) To handle errors in the code C) To make decisions based on certain conditions D) To define functions</p> <p>Q2: Which of the following is an example of an iterative statement mentioned in the source? A) if B) elif C) else D) for</p>

	<p>Q3: What is the difference between for and while loops based on the source?</p> <p>A) for loops are used for decision-making, while while loops are for repetition B) for loops are used for fixed iterations, while while loops are used for variable iterations C) for loops handle errors, while while loops define functions D) for loops are only for lists, while while loops are for numbers</p> <p>Q4: Which of the following best describes the function of conditional statements in programming according to the source text?</p> <p>A) To handle user inputs B) To enable decision-making C) To manage memory D) To optimize performance</p>
32	<p>Source Text: "In Python, strings are sequences of characters. Lists are mutable sequences, typically used to store collections of homogeneous items. Tuples are immutable sequences, often used to store collections of heterogeneous data. Dictionaries are mutable mappings of keys to values. Modules are files containing Python definitions and statements, which can be imported to provide reusable code."</p> <p>Questions:</p> <p>Q1: How are tuples different from lists based on the source text?</p> <p>A) Tuples are mutable, and lists are immutable. B) Tuples are immutable, and lists are mutable. C) Tuples store key-value pairs, and lists store sequences. D) Tuples can be imported, and lists cannot.</p> <p>Q2: What is the primary purpose of a dictionary in Python according to the source text?</p> <p>A) To store sequences of characters B) To store collections of homogeneous items C) To store collections of heterogeneous data D) To map keys to values</p> <p>Q3: If you need a collection where the order of elements cannot be changed once defined, which Python data structure should you use?</p> <p>A) List B) Dictionary C) Tuple D) Module</p> <p>Q4: According to the source text, what is the main use of modules in Python?</p> <p>A) To store sequences of characters B) To store collections of homogeneous items C) To store reusable code D) To map keys to values</p>
Section E(5 marks)	
33	<p>Rehana has got her first laptop from her brother who is an engineering student. He gave his own laptop to Rehana. She is now thinking which Operating system should be installed on the laptop : Microsoft Windows, Ubuntu, Linux. She has heard a lot about open-source, proprietary software, free software and freeware. So she wants to decide keeping the best features and benefits in mind.</p> <p>A. Which of these operating systems is open source ?</p> <p>a. Microsoft Windows b) Linux c) Ubuntu d) All of these</p> <p>B. What is a free software ?</p> <p>a. No money is required to use it b. It Comes as a complimentary gift when you purchase a paid software.</p>

	<p>c. It gives user the freedom to use it as they want d. It is available everywhere.</p> <p>C. What is the appropriate term that should be used for software whose source code is available and the user can utilize it according to their needs ? a. Free Software b) Open Source Software c) Free and Open Source Software d). Any of the above</p> <p>D. Which of the following categories are opposite to Free and Open Source Software? a. Proprietary Software b). Secondary Software c). Closed Source Software d). Virtual Source Software.</p> <p>E. Microsoft Windows is a ____ type of software? a. Proprietary b). Open-Source c). Freeware d). Free Software.</p>
34	<p>Consider the following code segment for the questions A to E:</p> <pre> a=int(input("enter an integer")) b=int(input("enter an integer")) if a<=0: b=b+1 else: a=a+1 if a>0 and b>0: print("W") elif a>0: print("X") if b>0: print("Y") else: print("Z") </pre> <p>A. What letters will be printed if the user enters 0 for a and 0 for b? a. Only W b). Only X c). Only Y d) W and X e) W,X and Y</p> <p>B. What letters will be printed if the user enters 1 for a and 1 for b? a. W and X b). W and Y c). X and Y d). X and Z e). W,X and Y</p> <p>C. What letters will be printed if the user enters 1 for a and -1 for b? a. W and X b). X and Y c). Y and Z d). X and Z e). W and Z</p> <p>D. What letters will be printed if the user enters 1 for a and 0 for b? a. W and X b). X and Y c). Y and Z d). X andZ e). W and Z</p> <p>E. What letters will be printed if the user enters -1 for a and -1 for b? a. Only W b) Only X c) Only Y d) Only Z e) No letters are printed</p>
35	<p>Carefully go through the code given below and answer the questions based on it:</p> <pre> inputStr=input("Give me a string") bigInt=0 littleInt=0 otherInt=0 for ele in inputStr: if ele>='a' and ele<='m': #Line 1 littleInt=littleInt+1 </pre>

```

elif ele>'m' and ele<='z':
    bigInt=bigInt+1
else:
    otherInt=otherInt+1
print(bigInt) #Line 2
print(littleInt) #Line 3
print(otherInt) #Line 4
print(inputStr.isdigit()) #Line 5

```

- A.** Given the input “abcd” what output is produced by Line 2?
a. 0 b) 1 c) 2 d) 3 e) 4
- B.** Given the input “Hi Mom” what output is produced by Line 3?
a. 0 b) 1 c) 2 d) 3 e) 4
- C.** Given the input “Hi Mom” what output is produced by Line 4?
a. 0 b) 1 c) 2 d) 3
- D.** Given the input “1+2=3” what output is produced by Line 5?
a. 0 b). 1 c). True d) False e) None of these
- E.** Given the input “Hi Mom”, what changes result from modifying Line 1 from
if ele>='a' and ele<='m' to the expression
if ele>='a' and ele<'m'?
- a. No change b). otherInt would be larger
c. littleInt would be larger d) bigInt would be larger
e. None of these

General Instructions:

- Please check this question paper contains 35 questions.
- The paper is divided into 5 Sections- A, B, C, D and E.
- Section A, consists of 18 questions (1 to 18). Each question carries 1 Mark.
- Section B, consists of 7 questions (19 to 25). Each question carries 2 Marks.
- Section C, consists of 5 questions (26 to 30). Each question carries 3 Marks.
- Section D, consists of 3 questions (31 to 33). Each question carries 5 Marks.
- Section E, consists of 2 questions (34 to 35). Each question carries 4 Marks.
- All programming questions are to be answered using Python Language only

Q.N O	SECTION- A	MARK S
1	Which of the following comes under Universal gate? AND b. OR c. NOT d. NAND	1
2	What is the full form of ISCII a. International standard Code for Information Interchange b. Indian Standard code for Information Interchange c. International Standard Code for Information Interchange d. None of these	1
3	Operating system is an example of a. Application software b. System software c. Utility program d. None of these	1
4	The Physical components of computer are called a. Hardware b. Software c. Firmware d. CPU	1
5	State True or False: “In a Python program, if a break statement is given in a nested loop, it terminates the execution of all loops in one go.”	1
6	Consider the given expression: not True and False or True Which of the following will be correct output if the given expression is evaluated? (a) True (b) False (c) NONE (d) NULL	1

23	<p>a. Define Cache Memory</p> <p>b. 1 Gb=_____mb</p>	2
24	<p>Write the Python statement for each of the following tasks using BUILTIN functions/methods only:</p> <p>(i) To insert an element 50 at the second position, in the list L1.</p> <p>(ii) To delete the last element of List L1.</p>	1+1
25	<p>What will be the output of following program:</p> <pre>L=[10,20,30,40,50,60] for i in range(1,6): L[i-1]=L[i] for i in range(0,6): print(L[i],end=")</pre>	2
Section- C		
26	<p>What is Software. Give two examples. Explain the two types of software and give example of each.</p>	3
27	<p>Write a program in Python, which accepts a list L of integers and displays the sum of all such integers from the list L which end with the digit 3.</p> <p>For example, if the list L is [123, 10, 13, 15, 23] then the program should display the sum of 123, 13, 23, i.e. 159 as follows: Sum of integers ending with digit 3 = 159</p>	3
28	<p>Write a program to find whether the number is palindrome or not.</p> <p style="text-align: center;">Or</p> <p>Write a program to generate N terms of Fibonacci series.</p>	3
29	<p>Predict the output of the code given below:</p> <pre>s="welcome2cs" n = len(s) m="" for i in range(0, n): if (s[i] >= 'a' and s[i] <= 'm'): m = m +s[i].upper() elif (s[i] >= 'n' and s[i] <= 'z'): m = m +s[i-1] elif (s[i].isupper()): m = m + s[i].lower() else: m = m +'&' print(m)</pre>	3

30	<p>Find the output:</p> <p>(i) A=[1,2,3,4,5,6,7,8,9,10] del A[:5] print(A)</p> <p>(ii) List1=[12,26,80,10] List2=List1*3 Print(List2)</p> <p>(iii) L1=[2,6,7,8] L2=copy(L1) L2[2]=89 Print(L1)</p>	3
SECTION -D		
31	<p>a. Define index function in tuple. Give example.</p> <p>b. Write a program to count and display the frequency of elements in tuple.</p>	2+3
32	<p>Convert the following:</p> <p>a. (423)₁₀ to Hexadecimal</p> <p>b. (111100010001)₂ to Octal</p> <p>c. (2C1)₁₆ to Decimal</p> <p>d. (56)₁₀ to Binary</p> <p>e. (721)₈ to Hexadecimal</p>	5
33	<p>a. Define range function. Give one example.</p> <p>b. Mr. X has done the coding using if..elif and if..else. but he has done coding in such a manner that he himself get confused about the results and execution of the coding. Code written by him is given below. Help him in finding the output of the code.</p> <p>Consider the following code segment for the question (i) to (iv).</p> <pre> a=int(input("Enter an integer:")) b=int(input("Enter an integer:")) if a<=0: b=b+1 else: a=a+1 if a>0 and b>0: print("W") elif a>0: print("X") </pre>	1+4

	if b>0: print("Y") else: print("Z") (i)What letters will be printed if the user enters 0 for a and 0 for b ? (ii)What letters will be printed if the user enters 1 for a and 1 for b ? (iii)What letters will be printed if the user enters 1 for a and -1 for b ? (iv)What letters will be printed if the user enters 1 for a and 0 for b ?	
SECTION- E		
34	a. State and prove Demorgan's Law using truth table(both laws). b. Make the logic circuit diagram for the following expression. $(A'+B')(A+B')$	2+2
35	Write output of the following : $T1 = (10,20,30,40,50,60,70,80)$ <code>print(T1[1::2])</code> <code>print(T1[-1:-5:-2])</code> <code>print(T1[::-1])</code> <code>print(T1[:7:2])</code>	4

**** END OF PAPER****

BEST OF LUCK