

Marking Scheme link is given at every page.

SAMPLE PAPERS **CBSE EXAM 2025**



20 Sets

Class : 12th

Sub : Physics

How to see answers or marking scheme ?

CLICK HERE TO SEE ANSWERS



Click above on Every page

If you are unable to click, please open this file using a PDF viewer in Google Drive.

Disclaimer: These papers are based on the SQP released by CBSE and published by a private organization just for the practice of the students. CBSE has not released these papers and CBSE is not related to these papers in any manner. Publisher of these papers clearly state that these papers are only for practice of students and questions may not be come in main exam.

Sample Paper 01

Class XII 2024-25

Physics

Time: 3 Hours

Max. Marks: 70

General Instructions:

1. There are 33 questions in all. All questions are compulsory.
2. This question paper has five sections: Section A, Section B, Section C, Section D and Section E.
3. All the sections are compulsory.
4. Section A contains sixteen questions, twelve MCQ and four assertion reasoning based of 1 mark each, Section B contains five questions of 2 marks each, Section C contains seven questions of 3 marks each, Section D contains two case study based questions of 4 marks each and Section E contains three long questions of 5 marks each.
5. There is no overall choice. However, an internal choice has been provided in one question in Section B, one question in Section C, one question in each CBQ in Section D and all three questions in Section E. You have to attempt only one of the choices in such questions
6. Use of calculators is not allowed.
7. You may use the following values of physical constants where ever necessary
 - i. $c = 3 \times 10^8$ m/s
 - ii. $m_e = 9.1 \times 10^{-31}$ kg
 - iii. $e = 1.6 \times 10^{-19}$ C
 - iv. $\mu_0 = 4\pi \times 10^{-7}$ TmA⁻¹
 - v. $h = 6.63 \times 10^{-34}$ Js
 - vi. $\epsilon_0 = 8.854 \times 10^{-12}$ C²N⁻¹m⁻²
 - vii. Avogadro's number = 6.023×10^{23} per gram mole

SECTION-A

1. When a body is connected to the earth, then electrons from the earth, flow into the body. It means that the body is
 - (a) unchanged
 - (b) an insulator
 - (c) positively charged
 - (d) negatively charged
2. A bar magnet of magnetic moment M is cut into two parts of equal length. The magnetic moment of either part is
 - (a) M
 - (b) $M/2$
 - (c) $2M$
 - (d) Zero
3. The radius of curvature of plane mirror is
 - (a) infinite
 - (b) zero
 - (c) +5 cm
 - (d) -5 cm
4. The interference occurs in which of the following waves?
 - (a) transverse
 - (b) longitudinal
 - (c) electromagnetic
 - (d) all of these
5. Rutherford's α -particle experiment showed that the atoms have
 - (a) proton
 - (b) nucleus
 - (c) neutron
 - (d) electrons

Continue on next page.....

CLICK HERE TO SEE ANSWERS



6. The net charge on a current carrying conductor is
(a) zero (b) constant
(c) varying (d) negative
7. Lenz's law is associated with principle of conservation of
(a) charge (b) mass
(c) energy (d) momentum
8. If the uniform electric field exists along X-axis, then equipotential is along
(a) XY-plane (b) XZ-plane
(c) YZ-plane (d) anywhere
9. The value of peak AC in a 220 V mains is
(a) 220 V (b) $110\sqrt{2}$ V
(c) $220\sqrt{2}$ V (d) $440\sqrt{2}$ V
10. The direction of transmission of electromagnetic wave is
(a) Parallel to \vec{E} (b) Parallel to \vec{B}
(c) Parallel to $\vec{B} \times \vec{E}$ (d) Parallel to $\vec{E} \times \vec{B}$
11. If momentum of a particle is doubled, then its de-Broglie's wavelength will
(a) be half (b) be two times
(c) be four times (d) remain unchanged
12. The direction of magnetic field produced by a current-carrying small element of any shape is given by
(a) lenz law (b) newton's law
(c) right-hand thumb rule (d) fleming left-hand rule
13. **Assertion :** Blue colour of sky appears due to scattering of blue colour.
Reason : Blue colour has shortest wave length in visible spectrum.
(a) Both Assertion and Reason are correct and Reason is the correct explanation of Assertion.
(b) Both Assertion and Reason are correct, but Reason is not the correct explanation of Assertion.
(c) Assertion is correct but Reason is incorrect.
(d) Assertion is incorrect but Reason is correct.
14. **Assertion (A) :** A small metal ball is suspended in a uniform electric field with an insulated thread. If high energy X-ray beam falls on the ball, the ball will be deflected in the electric field.
Reason (R) : X-rays emits photoelectrons and metal becomes negatively charged.
(a) Both Assertion and Reason are correct and Reason is the correct explanation of Assertion.
(b) Both Assertion and Reason are correct, but Reason is not the correct explanation of Assertion.
(c) Assertion is correct but Reason is incorrect.
(d) Assertion is incorrect but Reason is correct.
15. **Assertion :** Standard optical diffraction gratings can not be used for discriminating between X-ray wavelength.
Reason : The grating spacing is not of the order of X-ray wavelengths.
(a) Both Assertion and Reason are correct and Reason is the correct explanation of Assertion.
(b) Both Assertion and Reason are correct, but Reason is not the correct explanation of Assertion.
(c) Assertion is correct but Reason is incorrect.
(d) Assertion is incorrect but Reason is correct.



16. **Assertion :** X-ray travel with the speed of light.
Reason : X-rays are electromagnetic rays.
- (a) Both Assertion and Reason are correct and Reason is the correct explanation of Assertion.
 - (b) Both Assertion and Reason are correct, but Reason is not the correct explanation of Assertion.
 - (c) Assertion is correct but Reason is incorrect.
 - (d) Assertion is incorrect but Reason is correct.

SECTION-B

17. How does oscillating charge produce electromagnetic waves?
18. A hollow metal sphere of radius 5 cm is charged such that potential on its surface is 10 V. What is the potential at the centre of the sphere ?
19. Two identical cells, each of emf E , having negligible internal resistance, are connected in parallel with each other across an external resistance R . What is the current through this resistance?
20. Define stopping potential.

OR

Write the expression for the de-Broglie wavelength associated with a charged particle having charge q and mass m , when it is accelerated by a potential.

21. State two characteristic properties distinguishing behaviour of paramagnetic and diamagnetic materials.

SECTION-C

22. Draw path of rays for astronomical telescope in normal adjustment.
23. What is the nature of electrostatic force between two point electric charges q_1 and q_2 if
- (i) $q_1 + q_2 > 0$?
 - (ii) $q_1 + q_2 < 0$?
24. A circular coil of closely wound N turns and radius r carries a current I . Write the expressions for the following:
- (i) The magnetic field at its centre.
 - (ii) The magnetic moment of this coil.
25. A bar magnet is moved in the direction indicated by the arrow between two coils PQ and CD . Predict the directions of induced current in each coil.

[CLICK HERE TO SEE ANSWERS](#)



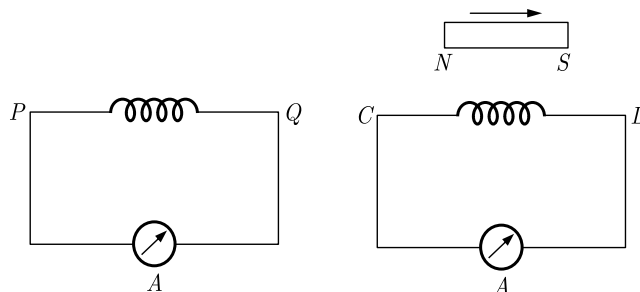

26. In a typical nuclear reaction, e.g.,

$${}^2_1\text{H} + {}^2_1\text{H} \longrightarrow {}^3_2\text{He} + {}^1_0n + 3.27 \text{ MeV}$$
 although number of nucleons is conserved, yet energy is released. How? Explain.
27. Conduction and displacement currents are individually discontinuous, but their sum is continuous.

OR

Name the parts of the electromagnetic spectrum which is

- (i) suitable for RADAR systems in aircraft navigations.
- (ii) used to treat muscular strain.
- (iii) used as a diagnostic tool in medicine.

Write in brief, how these waves can be produced.

28. What is difference between diffraction and interference?

SECTION-D

Case Study Based Questions.

Read the following paragraph and answer the questions that follow.

29. A photodiode is an optoelectronic device in which current carriers are generated by photons through photo-excitation i.e., photo conduction by light. It is a $p-n$ junction fabricated from a photosensitive semiconductor and provided with a transparent window so as allow light to fall on its function. A photodiode can turn its current ON and OFF in nanoseconds. So, it can be used as a fastest photo-detector.

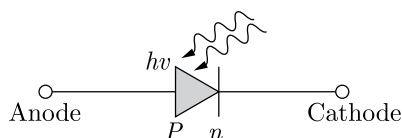

- (i) A $p-n$ photodiode is fabricated from a semiconductor with a band gap of 2.5 eV. It can detect a signal of wavelength
 - (a) 4000 nm
 - (b) 6000 nm
 - (c) 4000 Å
 - (d) 6000 Å

CLICK HERE TO INSTALL NODIA APP



- (ii) Three photo diodes D_1 , D_2 and D_3 are made of semiconductors having band gap of 2.5 eV, 2 eV and 3 eV, respectively. Which one will be able to detect light of wavelength 6000 Å?
- (a) D_1 (b) D_2
(c) D_3 (d) D_1 and D_2 both
- (iii) Photodiode is a device
- (a) which is always operated in reverse bias
(b) which of always operated in forward bias
(c) in which photo current is independent of intensity of incident radiation
(d) which may be operated in forward or reverse bias.
- (iv) To detect light of wavelength 500 nm, the photodiode must be fabricated from a semiconductor of minimum bandwidth of
- (a) 1.24 eV (b) 0.62 eV
(c) 2.48 eV (d) 3.2 eV

OR

Photodiode can be used as a photodetector to detect

- (a) optical signals (b) electrical signals
(c) both (a) and (b) (d) none of these

30. A compound microscope is an optical instrument used for observing highly magnified images of tiny objects. Magnifying power of a compound microscope is defined as the ratio of the angle subtended at the eye by the final image to the angle subtended at the eye by the object, when both the final image and the object are situated at the least distance of distinct vision from the eye. It can be given that : $m = m_e \times m_o$, where m_e is magnification produced by eye lens and m_o , is magnification produced by objective lens. Consider a compound microscope that consists of an objective lens of focal length 2.0 cm and an eyepiece of focal length 6.25 cm separated by a distance of 15 cm.

- (i) The object distance for eye-piece, so that final image is formed at the least distance of distinct vision, will be
- (a) 3.45 cm (b) 5 cm
(c) 1.29 cm (d) 2.59 cm
- (ii) How far from the objective should an object be placed in order to obtain the condition described in part(i)?
- (a) 4.5 cm (b) 2.5 cm
(c) 1.5 cm (d) 3.0 cm
- (iii) What is the magnifying power of the microscope in case of least distinct vision?
- (a) 20 (b) 30
(c) 40 (d) 10
- (iv) The intermediate image formed by the objective of a compound microscope is
- (a) real, inverted and magnified
(b) real, erect, and magnified
(c) virtual, erect and magnified
(d) virtual, inverted and magnified

OR

The magnifying power of a compound microscope increases with

- (a) the focal length of objective lens is increased and that of eye lens is decreased
(b) the focal length of eye lens is increased and that of objective lens is decreased

CLICK HERE TO SEE ANSWERS



- (c) focal lengths of both objects and eye-piece are increased
 (d) focal lengths of both objects and eye-piece are decreased.

SECTION-E

31. What is alternating current? How alternating e.m.f. and current is represented mathematically. What do you mean by time period, frequency and amplitude of alternating current?

OR

Show diagrammatically two different arrangements used for winding the primary and secondary coils in a transformer. Assuming the transformer to be an ideal one, write the expression for the ration of its:

- (i) Output voltage to input voltage.
 (ii) Output current to input current.

Mention two reasons for energy losses in an actual transformer.

32. Define the term binding energy. The binding energy of a nucleus A_ZX is given by the formula:

$$\text{B.E.} = [Zm_H + (A - Z)m_n - m({}^A_ZX)] c^2$$

where $m({}^A_ZX)$ is the atomic mass of X . Derive this equation, state clearly the approximation involved and say it is very safe approximation.

OR

Give reason for :

- (i) Lighter elements are better moderators for a nuclear reactor than heavier elements.
 (ii) In a natural uranium reactor, heavy water is preferred moderator as compared to ordinary water.
 (iii) Cadmium rods are provided in a reactor.
 (iv) Very high temperature as those obtained in the interior of the sun are required for fusion reaction.

33. What do you understand by the resistivity of a conductor? Discuss its temperature dependence for a

- (i) Metallic conductor
 (ii) Semiconductor
 (iii) Ionic conductor
 (iv) Electrolyte.

OR

Determine the potentials at the points X_1 and X_2 in the circuit.

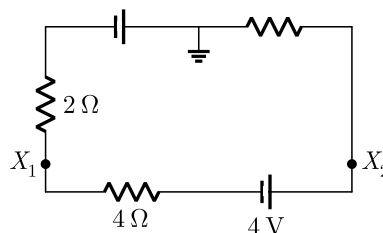

□□□□□□



Sample Paper 02

Class XII 2024-25

Physics

Time: 3 Hours

Max. Marks: 70

General Instructions:

1. There are 33 questions in all. All questions are compulsory.
2. This question paper has five sections: Section A, Section B, Section C, Section D and Section E.
3. All the sections are compulsory.
4. Section A contains sixteen questions, twelve MCQ and four assertion reasoning based of 1 mark each, Section B contains five questions of 2 marks each, Section C contains seven questions of 3 marks each, Section D contains two case study based questions of 4 marks each and Section E contains three long questions of 5 marks each.
5. There is no overall choice. However, an internal choice has been provided in one question in Section B, one question in Section C, one question in each CBQ in Section D and all three questions in Section E. You have to attempt only one of the choices in such questions
6. Use of calculators is not allowed.
7. You may use the following values of physical constants where ever necessary
 - i. $c = 3 \times 10^8$ m/s
 - ii. $m_e = 9.1 \times 10^{-31}$ kg
 - iii. $e = 1.6 \times 10^{-19}$ C
 - iv. $\mu_0 = 4\pi \times 10^{-7}$ TmA⁻¹
 - v. $h = 6.63 \times 10^{-34}$ Js
 - vi. $\epsilon_0 = 8.854 \times 10^{-12}$ C²N⁻¹m⁻²
 - vii. Avogadro's number = 6.023×10^{23} per gram mole

SECTION-A

1. The drift velocity V_d and applied electric field E of a conductor are related as
 - (a) $V_d \propto \sqrt{E}$
 - (b) $V_d \propto E$
 - (c) $V_d \propto E^2$
 - (d) $V_d = \text{constant}$
2. In a circuit, the current lags behind the voltage by a phase difference of $\pi/2$ radians. The circuit contains which of the following?
 - (a) only R
 - (b) only L
 - (c) only C
 - (d) R and C
3. According to classical theory, the path of an electron in Rutherford's atom is
 - (a) spiral
 - (b) circular
 - (c) parabolic
 - (d) straight line
4. If a ray of light is incident on a plane mirror at an angle of 30° , then deviation produced by the plane mirror is
 - (a) 30°
 - (b) 60°
 - (c) 90°
 - (d) 120°
5. If the intensity of light falling on a metal is increased, then
 - (a) K.E. of photoelectrons increases
 - (b) photoelectric current increases
 - (c) K.E. of photoelectrons decreases
 - (d) photoelectric current remains constant

Continue on next page.....

[CLICK HERE TO SEE ANSWERS](#)



6. At what distance of a point, from a long straight wire carrying a current of 12 A will the magnetic field be equal to $3 \times 10^{-5} \text{ T}$?
(a) 8 cm (b) 16 cm
(c) 32 cm (d) 64 cm
7. 1 stat-coulomb = coulomb.
(a) 3×10^9 (b) 3×10^{-9}
(c) $\frac{1}{3} \times 10^9$ (d) $\frac{1}{3} \times 10^{-9}$
8. When exposed to sunlight, thin films of oil on water often exhibit brilliant colours due to the phenomenon of
(a) interference (b) diffraction
(c) dispersion (d) polarisation
9. S.I. unit of pole strength is
(a) N (b) $N/A - m$
(c) $A - m$ (d) T
10. To convert mechanical energy into electrical energy one can use
(a) D.C. dynamo (b) A.C. dynamo
(c) Motor (d) Transformer
11. The waves which can not travel in vacuum are
(a) X-rays (b) radio-waves
(c) infrasonic waves (d) ultra-violet waves
12. The capacitance of a parallel plate capacitor by the introduction of a dielectric between the plates of capacitor.
(a) increases (b) decreases
(c) remains same (d) nothing can be said
13. **Assertion :** A red object appears dark in the yellow light.
Reason : The red colour is scattered less.
(a) Both Assertion and Reason are correct and Reason is the correct explanation of Assertion.
(b) Both Assertion and Reason are correct, but Reason is not the correct explanation of Assertion.
(c) Assertion is correct but Reason is incorrect.
(d) Assertion is incorrect but Reason is correct.
14. **Assertion :** Radio waves can be polarised.
Reason : Sound waves in air are longitudinal in nature.
(a) Both Assertion and Reason are correct and Reason is the correct explanation of Assertion.
(b) Both Assertion and Reason are correct, but Reason is not the correct explanation of Assertion.
(c) Assertion is correct but Reason is incorrect.
(d) Assertion is incorrect but Reason is correct.
15. **Assertion (A) :** If the distance between parallel plates of a capacitor is halved and dielectric constant is made three times, then the capacitance becomes six times.
Reason (R) : Capacitance of the capacitor does not depend upon the nature of the material of the plates.
(a) Both Assertion and Reason are correct and Reason is the correct explanation of Assertion.
(b) Both Assertion and Reason are correct, but Reason is not the correct explanation of Assertion.



- (c) Assertion is correct but Reason is incorrect.
(d) Assertion is incorrect but Reason is correct.

16. **Assertion :** In Young's double slit experiment the two slits are at distance d apart. Interference pattern is observed on a screen at distance D from the slits. At a point on the screen when it is directly opposite to one of the slits, a dark fringe is observed. Then, the wavelength of wave is proportional to square of distance of two slits.

Reason : For a dark fringe intensity is zero.

- (a) Both Assertion and Reason are correct and Reason is the correct explanation of Assertion.
(b) Both Assertion and Reason are correct, but Reason is not the correct explanation of Assertion.
(c) Assertion is correct but Reason is incorrect.
(d) Assertion is incorrect but Reason is correct.

SECTION-B

17. What is the angle of dip at a place where the horizontal and vertical components of the earth's magnetic field are equal?
18. Graph showing the variation of current versus voltage to a material GaAs is shown in the figure. Identify the region of

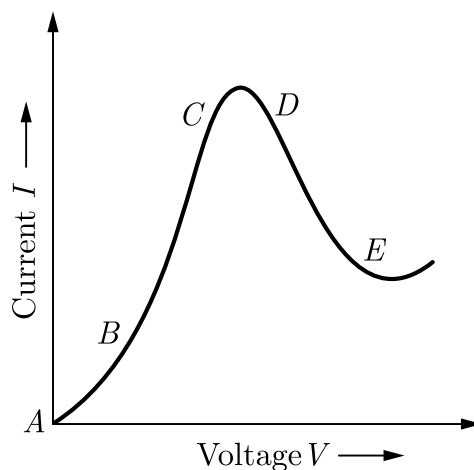

- (i) negative resistance.
(ii) where Ohm's law is obeyed ?

19. State the important properties of displacement current.
20. Write the basic features of photon picture of electromagnetic radiation on which Einstein's photoelectric equation is based.

OR

Show the variation of photocurrent with collector plate potential for different intensity but same frequency of incident radiation.

Continue on next page.....

[CLICK HERE TO SEE ANSWERS](#)



21. Why there is no work done in moving a charge from one point to another on an equipotential surface ?

SECTION-C

22. Draw energy band diagram of n -typed and p -typed semiconductor at temperature $T > 0$ K. Mark the donor and acceptor energy level with their energies.
23. Describe two commonly used devices which use polarised light.
24. Define uniform and non-uniform electric fields. How are they represented geometrically?
25. Explain, giving reasons, the basic difference in converting a galvanometer into (1) a voltmeter and (2) an ammeter.
26. When is the magnetic flux taken as positive and negative?
27. Answer the following questions :
- Name the electromagnetic waves which are suitable for RADAR systems used in aircraft navigation. Write the range of frequency of these waves.
 - If the earth does not have atmosphere, would its average surface temperature be higher or lower than what it is now? Explain.
 - An electromagnetic wave exerts pressure on the surface on which it is incident. Justify.

OR

- Describe briefly how electromagnetic waves are produced by oscillating charges.
 - Give one use of each of the following :
 - Microwaves
 - Ultraviolet rays
 - Infrared rays
 - Gamma rays
28. In an experiment of α -particle scattering by a thin foil of gold, draw a plot showing the number of particles scattered versus the scattering angle θ . Why is it that a very small fraction of the particles are scattered at $\theta > 90^\circ$?

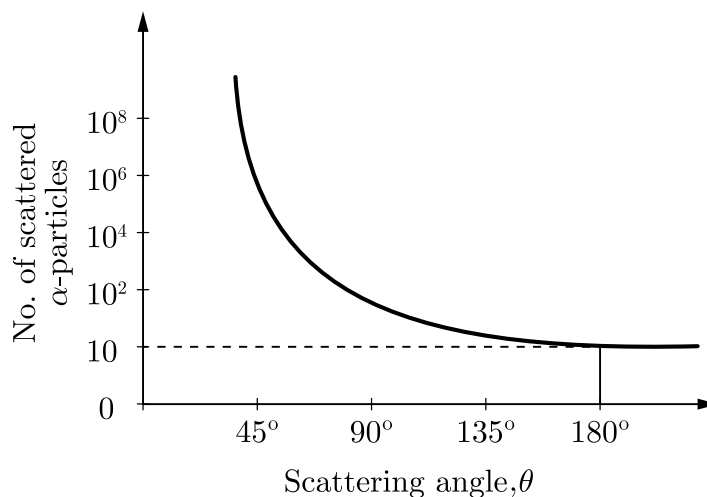

[CLICK HERE TO INSTALL NODIA APP](#)



SECTION-D

Case Study Based Questions.

Read the following paragraph and answer the questions that follow.

29. p - n junction is a single crystal of Ge or Si doped in such a manner that one half portion of it acts as p -type semiconductor and other half functions as n -type semiconductor. As soon as a p - n junction is formed, the holes from the p -region diffuse into the n -region and electron from n -region diffuse in to p -region. This results in the development of V_B across the junction which opposes the further diffusion of electrons and holes through the junction.
- (i) In an unbiased p - n junction electrons diffuse from n -region to p -region because
- holes in p -region attract them
 - electrons travel across the junction due to potential difference
 - electron concentration in n -region is more as compared to that in p -region
 - only electrons move from n to p region and not the vice-versa
- (ii) Electron hole recombination in p - n junction may lead to emission of
- light
 - ultraviolet rays
 - sound
 - radioactive rays
- (iii) In an unbiased p - n junction
- potential at p is equal to that at n
 - potential at p is +ve and that at n is -ve
 - potential at p is more than that at n
 - potential at p is less than that at n .
- (iv) The potential of depletion layer is due to
- electrons
 - holes
 - ions
 - forbidden band

OR

In the depletion layer of unbiased p - n junction,

- it is devoid of charge carriers
 - has only electrons
 - has only holes
 - p - n junction has a weak electric field.
30. The lens maker's formula relates the focal length of a lens to the refractive index of the lens material and the radii of curvature of its two surfaces. This formula is called so because it is used by manufacturers to design lenses of required focal length from a glass of given refractive index. If the object is placed at infinity, the image will be formed at focus for both double convex lens and double concave lens. Therefore, lens maker's formula is,
- $$\frac{1}{f} = \left[\frac{\mu_2 - \mu_1}{\mu_1} \right] \left[\frac{1}{R_1} - \frac{1}{R_2} \right]$$
- When lens is placed in air, $\mu_1 = 1$ and $\mu_2 = \mu$. The lens maker formula takes the form,
- $$\frac{1}{f} = (\mu - 1) \left[\frac{1}{R_1} - \frac{1}{R_2} \right]$$
- (i) The radius of curvature of each face of biconcave lens with refractive index 1.5 is 30 cm. The focal length of the lens in air is
- 12 cm
 - 10 cm
 - 20 cm
 - 30 cm
- (ii) The radii of curvature of the faces of a double convex lens are 10 cm and 15 cm. If focal length is 12 cm, then refractive index of glass is

CLICK HERE TO SEE ANSWERS



- (a) 1.5 (b) 1.78
 (c) 2.0 (d) 2.52
- (iii) An under-water swimmer cannot see very clearly even in absolutely clear water because of
 (a) absorption of light in water
 (b) scattering of light in water
 (c) reduction of speed of light in water
 (d) change in the focal length of eye-lens
- (iv) A thin lens of glass ($\mu = 1.5$) of focal length 10 cm is immersed in water ($\mu = 1.33$). The new focal length is
 (a) 20 cm (b) 40 cm
 (c) 48 cm (d) 12 cm

OR

An object is immersed in a fluid. In order that the object becomes invisible, it should

- (a) behave as a perfect reflector
 (b) absorb all light falling on it
 (c) have refractive index one
 (d) have refractive index exactly matching with that of the surrounding fluid.

SECTION-E

- 31.** Express one atomic mass unit in energy units, first in Joules and then in MeV. Using this, express the mass defect of ${}^{16}_8\text{O}$ in MeV.

OR

Explain giving necessary reaction, how energy is released during :

- (i) fission
 (ii) fusion
- 32.** Define terminal potential difference of a cell. When a battery of emf e and internal resistance r is connected to a resistance R , a current I flows through it. Derive the relation between e , I , r and R .

OR

Two cells of emfs 1.5 V and 2.0 V having internal resistance $0.2\ \Omega$ and $0.3\ \Omega$ respectively are connected in parallel. Calculate the emf and internal resistance of the equivalent cell.

- 33.** (i) An AC source of voltage $V = V_0 \sin \omega t$ is connected to a series combination of L , C and R . Use the phasor diagram to obtain expression for impedance of the circuit and phase angle between voltage and current. Find the condition when current will be in phase with the voltage. What is the circuit in this condition called?
- (ii) In a series LR circuit $X_L = R$ and power factor of the circuit is P_1 . When capacitor with capacitance C such that $X_L = X_C$ is put in series, the power factor becomes P_2 . Calculate $\frac{P_1}{P_2}$.

OR

Draw a labelled diagram of a step-down transformer. State the principle of its working. Express the turn ratio in terms of voltages.

Find the ratio of primary and secondary currents in terms of turn ratio in an ideal transformer.

How much current is drawn by the primary of a transformer connected to 220 V supply when it delivers power to a 100 V - 500 W refrigerator?

□□□□□□

CLICK HERE TO INSTALL NODIA APP



Sample Paper 03

Class XII 2024-25

Physics

Time: 3 Hours

Max. Marks: 70

General Instructions:

1. There are 33 questions in all. All questions are compulsory.
2. This question paper has five sections: Section A, Section B, Section C, Section D and Section E.
3. All the sections are compulsory.
4. Section A contains sixteen questions, twelve MCQ and four assertion reasoning based of 1 mark each, Section B contains five questions of 2 marks each, Section C contains seven questions of 3 marks each, Section D contains two case study based questions of 4 marks each and Section E contains three long questions of 5 marks each.
5. There is no overall choice. However, an internal choice has been provided in one question in Section B, one question in Section C, one question in each CBQ in Section D and all three questions in Section E. You have to attempt only one of the choices in such questions
6. Use of calculators is not allowed.
7. You may use the following values of physical constants where ever necessary
 - i. $c = 3 \times 10^8$ m/s
 - ii. $m_e = 9.1 \times 10^{-31}$ kg
 - iii. $e = 1.6 \times 10^{-19}$ C
 - iv. $\mu_0 = 4\pi \times 10^{-7}$ Tm A^{-1}
 - v. $h = 6.63 \times 10^{-34}$ Js
 - vi. $\epsilon_0 = 8.854 \times 10^{-12}$ C $^2 N^{-1} m^{-2}$
 - vii. Avogadro's number = 6.023×10^{23} per gram mole

SECTION-A

1. The energy of a photon of wavelength λ is
 - (a) $hc\lambda$
 - (b) hc/λ
 - (c) $h\lambda/c$
 - (d) λ/hc
2. The waves which can not travel in vacuum are
 - (a) X-rays
 - (b) radio-waves
 - (c) infrasonic waves
 - (d) ultra-violet waves
3. A charged particle is released from rest in a region of steady and uniform electric and magnetic fields, which are parallel to each other. The particle will move in a
 - (a) circle
 - (b) helix
 - (c) cycloid
 - (d) straight line
4. If light waves emitted by two coherent sources have wavelengths λ_1 and λ_2 , then
 - (a) $\lambda_1 = \lambda_2$
 - (b) $\lambda_1 > \lambda_2$
 - (c) $\lambda_1 < \lambda_2$
 - (d) $\lambda_1 \lambda_2 = 1$
5. If voltage across a lamp increases by 2%, then increase in its power will be
 - (a) 1%
 - (b) 2%
 - (c) 3%
 - (d) 4%

Continue on next page.....

CLICK HERE TO SEE ANSWERS



6. A 2 m long solenoid with radius 2 cm and 2000 turns has a another solenoid of 1000 turns wound closely near its mid-point. The mutual inductance of solenoids is
(a) 0.8 mH (b) 1.6 mH
(c) 3.2 mH (d) 6.4 mH
7. A beam of light composed of red and green rays is incident obliquely at a point on the face of a rectangular glass slab. When coming out on the opposite parallel face, the red and green rays emerge from
(a) one point propagating in the same direction
(b) one point propagating in two different directions
(c) two points propagating in two different parallel directions
(d) two points propagating in two different non-parallel directions
8. Electric intensity due to an electric dipole varies with distance r as $E \propto r^n$, where n is equal to
(a) 0 (b) -1
(c) -2 (d) -3
9. A diamagnetic material in a magnetic field moves
(a) from weaker to stronger parts
(b) perpendicular to the field
(c) from stronger to weaker parts
(d) in none of the above directions
10. If a copper plate of thickness b is inserted a parallel plate capacitor, then its new capacity will be (where d = Distance between plates)
(a) $\frac{\epsilon_0 A}{d+b}$ (b) $\frac{\epsilon_0 A}{d-b}$
(c) $\frac{\epsilon_0 A}{2d-b}$ (d) $\frac{2\epsilon_0 A}{2d-b}$
11. In a LCR-circuit, the potential difference between the terminals of the inductance is 60 V, between terminals of the capacitor is 30 V and that between the terminals of the resistance is 40 V. The supply voltage will be
(a) 25 V (b) 50 V
(c) 100 V (d) 200 V
12. The ground state energy of hydrogen atom is -13.6 eV. What is the potential energy of the electron in this state?
(a) 0 eV (b) 1 eV
(c) 2 eV (d) -27.2 eV
13. **Assertion (A)** : Microscope magnifies the image.
Reason (R) : Angular magnification for image is more than object in microscope.
(a) Both Assertion and Reason are correct and Reason is the correct explanation of Assertion.
(b) Both Assertion and Reason are correct, but Reason is not the correct explanation of Assertion.
(c) Assertion is correct but Reason is incorrect.
(d) Assertion is incorrect but Reason is correct.
14. **Assertion** : In optical fibre, the diameter of the core is kept small.
Reason : This smaller diameter of the core ensures that the fibre should have incident angle more than the critical angle required for total internal reflection.
(a) Both Assertion and Reason are correct and Reason is the correct explanation of Assertion.
(b) Both Assertion and Reason are correct, but Reason is not the correct explanation of Assertion.
(c) Assertion is correct but Reason is incorrect.
(d) Assertion is incorrect but Reason is correct.

Continue on next page.....

CLICK HERE TO INSTALL NODIA APP

15. **Assertion :** At the first glance, the top surface of the Morpho butterfly's wing appears a beautiful blue-green. If the wind moves the colour changes.
Reason : Different pigments in the wing reflect light at different angles.
- (a) Both Assertion and Reason are correct and Reason is the correct explanation of Assertion.
(b) Both Assertion and Reason are correct, but Reason is not the correct explanation of Assertion.
(c) Assertion is correct but Reason is incorrect.
(d) Assertion is incorrect but Reason is correct.
16. **Assertion :** A disc-shaped magnet is deviated above a superconducting material that has been cooled by liquid nitrogen.
Reason : Superconducting repel a magnet.
- (a) Both Assertion and Reason are correct and Reason is the correct explanation of Assertion.
(b) Both Assertion and Reason are correct, but Reason is not the correct explanation of Assertion.
(c) Assertion is correct but Reason is incorrect.
(d) Assertion is incorrect but Reason is correct.

SECTION-B

17. Why does the Sun look reddish at sunset or sunrise?

OR

When observed from under water, all the objects above the surface can be seen within a cone of 97° . Why? Explain.

18. Figure shows the field lines due to a negative point charge. Give the sign of the potential energy difference of a small negative charge between the points A and B .

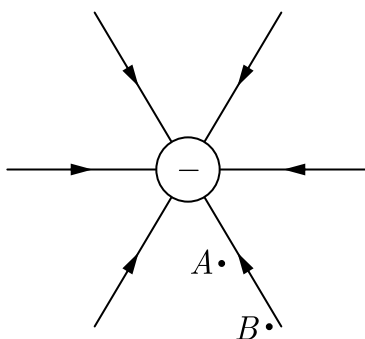

19. Define mean value and root mean square value of alternating current.
20. Does the emf represent a force of potential energy or work done per unit charge or potential difference? Does emf have electrostatic origin?
21. Why does paramagnetic substance move from weaker to stronger parts of non-uniform magnetic field?

Continue on next page.....

[CLICK HERE TO SEE ANSWERS](#)



SECTION-C

22. Give the physical significance of electric field.
23. Applying Biot-Savart's law deduce the expression for the magnetic field at the centre of a semicircular loop of radius R carrying current I .
24. Draw path of rays for astronomical telescope in normal adjustment.
25. In a typical nuclear reaction, e.g.,

$${}^2_1\text{H} + {}^2_1\text{H} \longrightarrow {}^3_2\text{He} + {}^1_0n + 3.27 \text{ MeV}$$
 although number of nucleons is conserved, yet energy is released. How? Explain.
26. Why is the classical Rutherford model for an atom of electron orbiting around the nucleus not able to explain the atomic structure?
27. State Malus law. Draw a graph showing the dependence of intensity of transmitted light on the angle between polariser and analyser.

OR

What will be the effect on interference fringes obtained in Young's double slit experiment if (1) one slit is covered, (2) a source of light of higher wavelength is used, (3) distance between two slits be increased to 1 cm and (4) distance between screen and double slit is increased?

28. Draw energy band diagram of n -typed and p -typed semiconductor at temperature $T > 0 \text{ K}$. Mark the donor and acceptor energy level with their energies.

SECTION-D

29. Net electric flux through a cube is the sum of fluxes through its six faces. Consider a cube as shown in figure, having sides of length $L = 10.0 \text{ cm}$. The electric field is uniform, has a magnitude $E = 4.00 \times 10^3 \text{ NC}^{-1}$ and is parallel to the xy plane at an angle of 37° measured from the $+x$ -axis towards the $+y$ -axis.

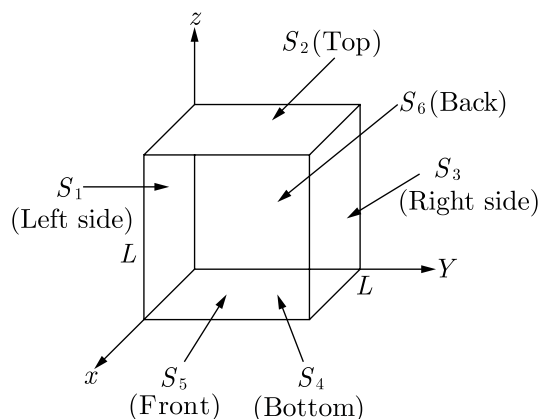

- (i) Electric flux passing through surface S_6 is
 (a) $-24 \text{ Nm}^2\text{C}^{-1}$ (b) $24 \text{ Nm}^2\text{C}^{-1}$
 (c) $32 \text{ Nm}^2\text{C}^{-1}$ (d) $-32 \text{ Nm}^2\text{C}^{-1}$
- (ii) Electric flux passing through surface S_1 is
 (a) $-24 \text{ Nm}^2\text{C}^{-1}$ (b) $24 \text{ Nm}^2\text{C}^{-1}$
 (c) $32 \text{ Nm}^2\text{C}^{-1}$ (d) $-32 \text{ Nm}^2\text{C}^{-1}$
- (iii) The surfaces that have zero flux are
 (a) S_1 and S_3 (b) S_5 and S_6
 (c) S_2 and S_4 (d) S_1 and S_2
- (iv) The total net electric flux through all faces of the cube is
 (a) $8 \text{ Nm}^2\text{C}^{-1}$ (b) $-8 \text{ Nm}^2\text{C}^{-1}$
 (c) $24 \text{ Nm}^2\text{C}^{-1}$ (d) zero

OR

The dimensional formula of surface integral $\oint \vec{E} \cdot d\vec{S}$ of an electric field is

- (a) $[\text{ML}^2\text{T}^{-2}\text{A}^{-1}]$ (b) $[\text{ML}^3\text{T}^{-3}\text{A}^{-1}]$
 (c) $[\text{M}^{-1}\text{L}^3\text{T}^{-3}\text{A}]$ (d) $[\text{ML}^{-3}\text{T}^{-3}\text{A}^{-1}]$

30. Interference is based on the superposition principle. According to this principle, at a particular point in the medium, the resultant displacement produced by a number of waves is the vector sum of the displacements produced by each of the waves. If two sodium lamps illuminate two pinholes S_1 and S_2 , the intensities will add up and no interference fringes will be observed on the screen. Here the source undergoes abrupt phase change in times of the order of 10^{-10} seconds.

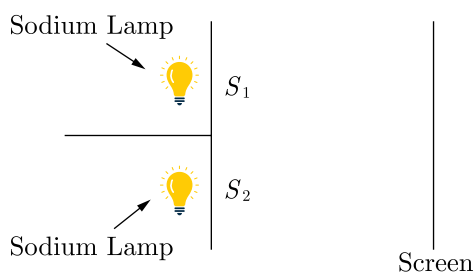

- (i) Two coherent sources of intensity 10 W/m^2 and 25 W/m^2 interfere to form fringes. Find the ratio of maximum intensity to minimum intensity.
 (a) 15.54 (b) 16.78
 (c) 19.72 (d) 18.39
- (ii) Which of the following does not show interference?
 (a) Soap bubble (b) Excessively thin film
 (c) A thick film (d) Wedge shaped film
- (iii) In a Young's double-slit experiment, the slit separation is doubled. To maintain the same fringe spacing on the screen, the screen-to-slit distance D must be changed to
 (a) $2D$ (b) $4D$
 (c) $D/2$ (d) $D/4$

CLICK HERE TO SEE ANSWERS



- (iv) The maximum number of possible interference maxima for slit separation equal to twice the wavelength in Young's double-slit experiment, is
- (a) infinite (b) five
(c) three (d) zero

OR

The resultant amplitude of a vibrating particle by the superposition of the two waves $y_1 = a \sin(\omega t + \frac{\pi}{3})$ and $y_2 = a \sin \omega t$ is

- (a) a (b) $\sqrt{2} a$
(c) $2a$ (d) $\sqrt{3} a$

SECTION-E

31. What are eddy currents? How are they produced? Give some experiments to demonstrate their existence.

OR

The magnetic flux linked with a coil is given by the equation: $\phi = 3t^2 + 4t + 9$ Wb. What is the magnitude of E.M.F. induced at $t = 2$ s?

32. With the help of a circuit diagram, explain the working of a junction diode as a full wave rectifier. Draw its input and output waveforms. Which characteristic property makes the junction diode suitable for rectification?

OR

A battery of emf 12 V and internal resistance 2Ω is connected to a 4Ω resistor as shown in the figure.

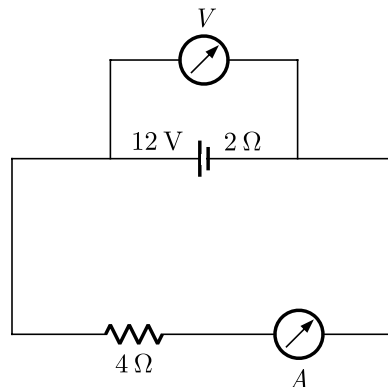

- (i) Show that a voltmeter when placed across the cell and across the resistor in turn, gives the same reading.
- (ii) To record the voltage and the current in the circuit why is voltmeter placed in parallel and ammeter in series in the circuit?
33. Prove mathematically that electromagnetic waves are transverse in nature.

OR

When an AC source is connected across a capacitor, current starts flowing through the circuit. Show how Ampere's circuital law is generalized to explain the flow of current through the capacitor. Hence obtain the expression for the displacement current inside the capacitor.

□□□□□□



Sample Paper 04

Class XII 2024-25

Physics

Time: 3 Hours

Max. Marks: 70

General Instructions:

1. There are 33 questions in all. All questions are compulsory.
2. This question paper has five sections: Section A, Section B, Section C, Section D and Section E.
3. All the sections are compulsory.
4. Section A contains sixteen questions, twelve MCQ and four assertion reasoning based of 1 mark each, Section B contains five questions of 2 marks each, Section C contains seven questions of 3 marks each, Section D contains two case study based questions of 4 marks each and Section E contains three long questions of 5 marks each.
5. There is no overall choice. However, an internal choice has been provided in one question in Section B, one question in Section C, one question in each CBQ in Section D and all three questions in Section E. You have to attempt only one of the choices in such questions
6. Use of calculators is not allowed.
7. You may use the following values of physical constants where ever necessary
 - i. $c = 3 \times 10^8$ m/s
 - ii. $m_e = 9.1 \times 10^{-31}$ kg
 - iii. $e = 1.6 \times 10^{-19}$ C
 - iv. $\mu_0 = 4\pi \times 10^{-7}$ TmA⁻¹
 - v. $h = 6.63 \times 10^{-34}$ Js
 - vi. $\epsilon_0 = 8.854 \times 10^{-12}$ C²N⁻¹m⁻²
 - vii. Avogadro's number = 6.023×10^{23} per gram mole

SECTION-A

1. A single slit of width 0.5 mm is illuminated by parallel light of wavelength 5000 \AA and diffraction pattern is observed on a screen 1 m from the slit. The width of the central maxima is
 - (a) 500 mm
 - (b) 600 mm
 - (c) 700 mm
 - (d) 800 mm
2. A diamagnetic material in a magnetic field moves
 - (a) from weaker to stronger parts
 - (b) perpendicular to the field
 - (c) from stronger to weaker parts
 - (d) in none of the above directions
3. A parallel plate air capacitor is charged to a potential difference of V . If distance between the plates is increased, then potential difference between the plates.
 - (a) decreases
 - (b) increases
 - (c) becomes zero
 - (d) does not change
4. In photoelectric effect, the number of electrons ejected per second is proportional to
 - (a) intensity of light
 - (b) wavelength of light
 - (c) frequency of light
 - (d) frequency of the metal
5. A battery of 12 V and internal resistance 0.5Ω is connected across a variable resistance R . The value of R , for which the power delivered is maximum is equal to
 - (a) 0.25Ω
 - (b) 0.5Ω
 - (c) 1.2Ω
 - (d) 2.4Ω

Continue on next page.....

CLICK HERE TO SEE ANSWERS



6. A current-carrying loop is placed in a uniform magnetic field. The torque acting on it does not depend upon
- (a) area of loop (b) shape of loop
(c) number of turns in loop (d) strength of current and magnetic field
7. A small piece of metal wire is dragged across the gap between the poles of a magnet in 0.4 s. If change in magnetic flux in the wire is 8×10^{-4} Wb, then E.M.F. induced in the wire is
- (a) 8×10^{-3} V (b) 6×10^{-3} V
(c) 4×10^{-3} V (d) 2×10^{-3} V
8. Three point charges are placed at the corners of an equilateral triangle as shown in figure. Assuming only electrostatic forces are acting, the system

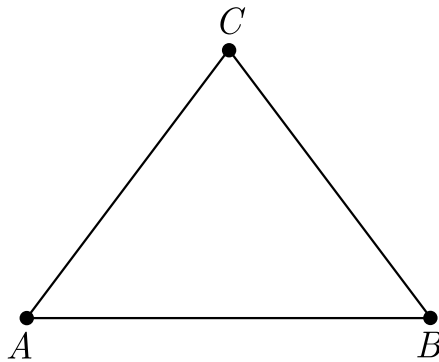

- (a) Can never be in equilibrium.
(b) Will be in equilibrium if charges rotate about the centre of the triangle.
(c) Will be in equilibrium if charges have same magnitude but different signs.
(d) Will be in equilibrium if charges have different magnitudes and different signs.
9. If the energy of hydrogen atom in ground state is -13.6 eV, then its energy in the first excited state will be
- (a) -3.4 eV (b) -6.8 eV
(c) -27.2 eV (d) -52.4 eV
10. A circular loop of area 0.01 m^2 carrying a current of 10 A, is held perpendicular to a magnetic field of intensity 0.1 T. The torque acting on the loop is
- (a) zero (b) 0.01 N-m
(c) 0.1 N-m (d) 0.8 N-m
11. A 2 m long solenoid with radius 2 cm and 2000 turns has a another solenoid of 1000 turns wound closely near its mid-point. The mutual inductance of solenoids is
- (a) 0.8 mH (b) 1.6 mH
(c) 3.2 mH (d) 6.4 mH
12. According to the Maxwell's displacement current law, a changing electric field is source of
- (a) an e.m.f. (b) magnetic field
(c) pressure gradient (d) all of these

Continue on next page.....

CLICK HERE TO INSTALL NODIA APP

13. **Assertion :** A white source of light during interference forms only white and black fringes.
Reason : Width of fringe is inversely proportional to the wavelength of the light used.
- (a) Both Assertion and Reason are correct and the Reason is a correct explanation of the Assertion.
(b) Both Assertion and Reason are correct but Reason is not a correct explanation of the Assertion.
(c) The Assertion is correct but Reason is incorrect.
(d) Both the Assertion and Reason are incorrect.
14. **Assertion :** If the temperature of a semiconductor is increased then its resistance decreases.
Reason : The energy gap between conduction band and valence band is very small.
- (a) Both Assertion and Reason are correct and the Reason is a correct explanation of the Assertion.
(b) Both Assertion and Reason are correct but Reason is not a correct explanation of the Assertion.
(c) The Assertion is correct but Reason is incorrect.
(d) Both the Assertion and Reason are incorrect.
15. **Assertion (A) :** The electric lines of forces diverges from a positive charge and converge at a negative charge.
Reason (A) : A charged particle free to move in an electric field always move along an electric line of force.
- (a) Both Assertion and Reason are correct and the Reason is a correct explanation of the Assertion.
(b) Both Assertion and Reason are correct but Reason is not a correct explanation of the Assertion.
(c) The Assertion is correct but Reason is incorrect.
(d) Both the Assertion and Reason are incorrect.
16. **Assertion :** Photoelectric saturation current increases with the increase in frequency of incident light.
Reason : Energy of incident photons increases with increase in frequency and as a result photoelectric current increases.
- (a) Both Assertion and Reason are correct and the Reason is a correct explanation of the Assertion.
(b) Both Assertion and Reason are correct but Reason is not a correct explanation of the Assertion.
(c) The Assertion is correct but Reason is incorrect.
(d) Both the Assertion and Reason are incorrect.

SECTION-B

17. A ray of light incident on an equilateral glass prism ($\mu_g = \sqrt{3}$) moves parallel to the base line of the prism inside. it Find the angle of incidence for this ray.
18. The motion of copper plate is damped when it is allowed to oscillate between the two poles of a magnet. What is the cause of this damping?
19. (i) Write the β -decay or tritium in symbolic form.
(ii) Why is it experimentally found difficult to detect neutrinos in this process?

Continue on next page.....

CLICK HERE TO SEE ANSWERS



20. The circuit shown in the figure has two oppositely connected ideal diodes connected in parallel. Find the current flowing through each diode in the circuit.

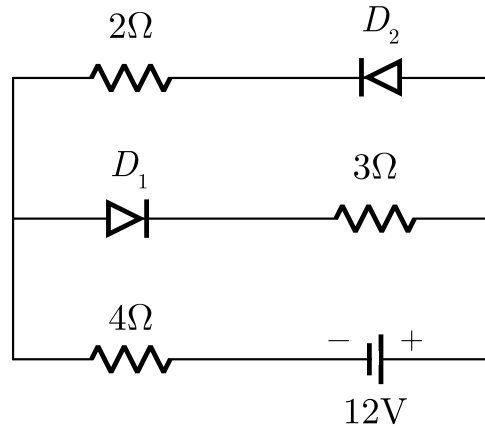

or

What do you mean by doping ? What is the dopants ?

21. Write an expression for the momentum carried by an electromagnetic wave.

SECTION-C

22. Using Rutherford model of the atom, derive the expression for the total energy of the electron in hydrogen atom. What is the significance of total negative energy possessed by the electron?
23. In Young's experiment, the width of the fringes obtained with light of wavelength 6000 \AA is 2.0 mm. Calculate the fringe width if the entire apparatus is immersed in a liquid medium of refractive index 1.33.
24. Two metallic spheres of exactly equal masses are taken. One is given a positive charge q coulomb and the other an equal negative charge by friction. Are their masses after charging equal?
25. Write the generalised expression for the Ampere's circuital law in terms of the conduction current and the displacement current. Mention the situation when there is
 (i) only conduction current and no displacement current.
 (ii) only displacement current and no conduction current.
26. Sketch a graph to show how the reactance of (1) a capacitor (2) an inductor varies as a function of frequency.

Continue on next page.....

CLICK HERE TO INSTALL NODIA APP



27. (i) Describe briefly three experimentally observed features in the phenomenon of photoelectric effect.
(ii) Discuss briefly how wave theory of light cannot explain these features.

OR

The given graph shows the variation of photoelectric current (I) with the applied voltage (V) for two different materials and for two different intensities of the incident radiations. Identify and explain using Einstein's photoelectric equation for the pair of curves that correspond to (i) different materials but same intensity of incident radiation, (ii) different intensities but same materials.

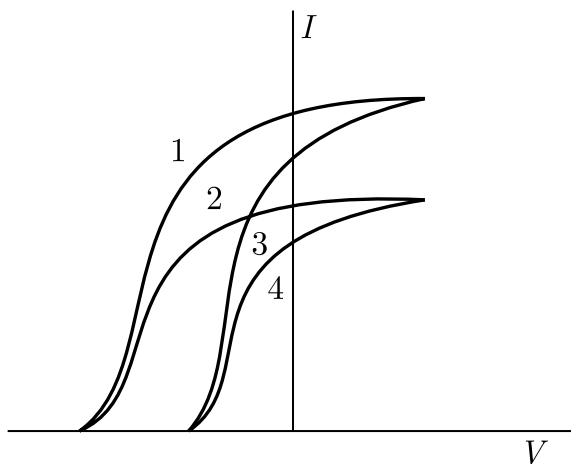

28. Considering the case of a parallel plate capacitor being charged, show how one is required to generalise Ampere's circuital law to include the term due to displacement current.

SECTION-D

Case Study Based Questions.

Read the following paragraph and answer the questions that follow.

29. From Bohr's atomic model, we know that the electrons have well defined energy levels in an isolated atom. But due to interatomic interactions in a crystal, the electrons of the outer shells are forced to have energies different from those in isolated atoms. Each energy level splits into a number of energy levels forming a continuous band. The gap between top of valence band and bottom of the conduction band in which no allowed energy levels for electrons can exist is called energy gap.

CLICK HERE TO SEE ANSWERS



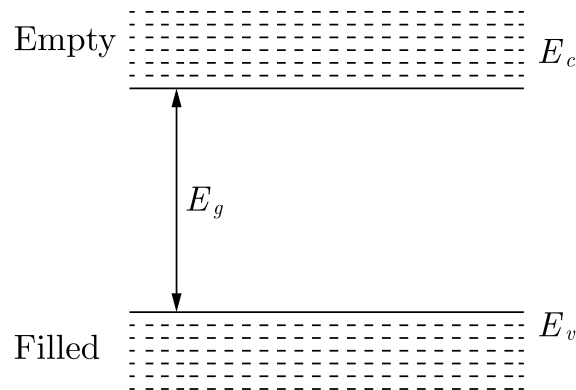

- (i) In an insulator energy band gap is
- (a) $E_g = 0$ (b) $E_g < 3 \text{ eV}$
(c) $E_g > 3 \text{ eV}$ (d) None of the above
- (ii) In a semiconductor, separation between conduction and valence band is of the order of
- (a) 0 eV (b) 1 eV
(c) 10 eV (d) 50 eV
- (iii) Based on the band theory of conductors, insulators and semiconductors, the forbidden gap is smallest in
- (a) conductors (b) insulators
(c) semiconductors (d) All of these
- (iv) Carbon, silicon and germanium have four valence electrons each. At room temperature which one of the following statements is most appropriate ?
- (a) The number of free electrons for conduction is significant only in Si and Ge but small in C.
(b) The number of free conduction electrons is significant in C but small in Si and Ge.
(c) The number of free conduction electrons is negligibly small in all the three.
(d) The number of free electrons for conduction is significant in all the three.

OR

Solids having highest energy level partially filled with electrons are

- (a) semiconductor (b) conductor
(c) insulator (d) none of these

30. An astronomical telescope is an optical instrument which is used for observing distinct images of heavenly bodies like stars, planets etc. It consists of two lenses. In normal adjustment of telescope, the final image is formed at infinity. Magnifying power of an astronomical telescope in normal adjustment is defined as the ratio of the angle subtended at the eye by the angle subtended at the eye by the final image to the angle subtended at the eye, by the object directly, when the final image and the object both lie at infinite distance from the eye. It is given by, $m = \frac{f_o}{f_e}$. To increase magnifying power of an astronomical telescope in normal adjustment, focal length of objective lens should be large and focal length of eye lens should be small.

- (i) An astronomical telescope of magnifying power 7 consists of the two thin lenses 40 cm apart, in normal adjustment. The focal lengths of the lenses are

CLICK HERE TO INSTALL NODIA APP



- (a) 5 cm, 35 cm (b) 7 cm, 35 cm
(c) 17 cm, 35 cm (d) 5 cm, 30 cm
- (ii) An astronomical telescope has a magnifying power of 10. In normal adjustment, distance between the objective and eye piece is 22 cm. The focal length of objective lens is
(a) 25 cm (b) 10 cm
(c) 15 cm (d) 20 cm
- (iii) In astronomical telescope compare to eye piece, objective lens has
(a) negative focal length (b) zero focal length
(c) small focal length (d) large focal length
- (iv) To see stars, use
(a) simple microscope (b) compound microscope
(c) endoscope (d) astronomical telescope

OR

For large magnifying power of astronomical telescope

- (a) $f_o \ll f_e$ (b) $f_o = f_e$
(c) $f_o \gg f_e$ (d) none of these

SECTION-E

31. (i) In Young's double slit experiment, deduce the conditions for (i) constructive and (ii) destructive interference at a point on the screen. Draw a graph showing variation of the resultant intensity in the interference pattern against position X on the screen.
- (ii) Compare and contrast the pattern which is seen with two coherently illuminated narrow slits in Young's experiment with that seen for a coherently illuminated single slit producing diffraction.

or

- (i) Describe briefly how a diffraction pattern is obtained on a screen due to a single narrow slit illuminated by a monochromatic source of light. Hence, obtain the conditions for the angular width of secondary maxima and secondary minima.
- (ii) Two wavelengths of sodium light of 590 nm and 596 nm are used in turn to study the diffraction taking place at a single slit of aperture 2×10^{-6} m. The distance between the slit and the screen is 1.5 m. Calculate the separation between the positions of first maxima of the diffraction pattern obtained in the two cases.
32. Explain, using suitable diagram, the difference in the behaviour of a
- (i) Conductor
(ii) Dielectric in the presence of external electric field. Define the terms polarisation of a dielectric and write its relation with susceptibility.

or

- (i) Derive the expression for the energy stored in parallel plate capacitor. Hence, obtain the expression for the energy density of the electric field.
- (ii) A fully charged parallel plate capacitor is connected across an uncharged identical capacitor. Show that the energy stored in the combination is less than stored initially in the single capacitor.

Continue on next page.....

CLICK HERE TO SEE ANSWERS



33. (i) State Kirchhoff's rules for an electric network. Using Kirchhoff's rules, obtain the balance condition in terms of the resistances of four arms of Wheatstone bridge.
- (ii) In the meter bridge experimental set up, shown in the figure, the null point D is obtained at a distance of 40 cm from end A of the meter-bridge wire. If a resistance of $10\ \Omega$ is connected in series with R_1 , null point is obtained at $AD = 60$ cm. Calculate the values of R_1 and R_2 .

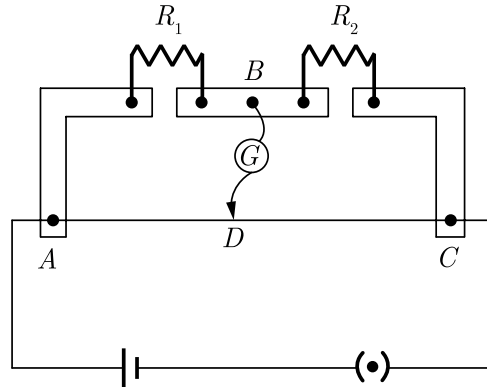

OR

- (i) Plot a graph showing variation of voltage V_s the current drawn from the cell. How can one get information from this plot about the emf of the cell and its internal resistance?
- (ii) Two cells of emf is E_1 and E_2 internal resistance r_1 and r_2 are connected in parallel. Obtain the expression for the emf and internal resistance of a single equivalent cell that can replace this combination?

□□□□□□



Sample Paper 05

Class XII 2024-25

Physics

Time: 3 Hours

Max. Marks: 70

General Instructions:

- There are 33 questions in all. All questions are compulsory.
- This question paper has five sections: Section A, Section B, Section C, Section D and Section E.
- All the sections are compulsory.
- Section A contains sixteen questions, twelve MCQ and four assertion reasoning based of 1 mark each, Section B contains five questions of 2 marks each, Section C contains seven questions of 3 marks each, Section D contains two case study based questions of 4 marks each and Section E contains three long questions of 5 marks each.
- There is no overall choice. However, an internal choice has been provided in one question in Section B, one question in Section C, one question in each CBQ in Section D and all three questions in Section E. You have to attempt only one of the choices in such questions
- Use of calculators is not allowed.
- You may use the following values of physical constants where ever necessary
 - $c = 3 \times 10^8$ m/s
 - $m_e = 9.1 \times 10^{-31}$ kg
 - $e = 1.6 \times 10^{-19}$ C
 - $\mu_0 = 4\pi \times 10^{-7}$ TmA⁻¹
 - $h = 6.63 \times 10^{-34}$ Js
 - $\epsilon_0 = 8.854 \times 10^{-12}$ C²N⁻¹m⁻²
 - Avogadro's number = 6.023×10^{23} per gram mole

SECTION-A

- When a ray of light enters a glass slab its wavelength
 - decreases
 - increases
 - remains unchanged
 - data are not complete
- In a purely resistive AC circuit, the current
 - is in phase with the e.m.f.
 - leads the e.m.f. by a difference of π radians phase
 - leads the e.m.f. by a phase difference of $\pi/2$ radians
 - lags behind the e.m.f. by phase difference of $\pi/4$ radians
- The frequency of X-rays is
 - 10^{12} Hz
 - 10^{14} Hz
 - 10^{16} Hz
 - 10^{18} Hz
- A particle of mass m and charge q moves with a constant velocity v along the positive x -direction. It enters a region containing a uniform magnetic field B directed along the negative z -direction, extending from $x = a$ to $x = b$. The minimum value of v required, so that the particle can just enter the region of $x > b$ is
 - $\frac{qbB}{m}$
 - $\frac{qaB}{m}$
 - $\frac{q(b-a)B}{m}$
 - $\frac{q(b+a)B}{2m}$

[CLICK HERE TO SEE ANSWERS](#)



5. A parallel plate capacitor is made by stacking n equally spaced plates connected alternatively. If capacitance between any two adjacent plates is C , then the resultant capacitance is
- (a) C (b) nC
(c) $(n - 1)C$ (d) $(n + 1)C$
6. The magnetic lines of force inside a bar magnet
- (a) do not exist
(b) are from north-pole to south-pole of the magnet
(c) are from south-pole to north-pole of the magnet
(d) depend upon the area of cross-section of the bar magnet
7. If a wire of length 2 m is moving with a velocity of 1 m-s^{-1} perpendicular to a magnetic field of 0.5 T, then E.M.F. induced in the wire will be
- (a) 0.2 V (b) 0.5 V
(c) 1 V (d) 2 V
8. The electric field at a distance 2 cm from the centre of a hollow spherical conducting shell of radius 4 cm having a charge of $2 \times 10^{-3} \text{ C}$ on its surface, is
- (a) zero (b) $1.1 \times 10^{10} \text{ V-m}^{-1}$
(c) $4.5 \times 10^{-10} \text{ V-m}^{-1}$ (d) $4.5 \times 10^{+10} \text{ V-m}^{-1}$
9. Electron-volt (eV) is the measure of
- (a) charge (b) potential difference
(c) current (d) energy
10. The frequency of X-rays is
- (a) 10^{12} Hz (b) 10^{14} Hz
(c) 10^{16} Hz (d) 10^{18} Hz
11. The core of a transformer is laminated, so as to
- (a) make it light weight (b) make it robust and strong
(c) increase the secondary voltage (d) reduce energy loss due to eddy current
12. Cathode rays can be deflected by
- (a) electric field (b) magnetic field
(c) both types of fields (d) none of these fields
13. **Assertion :** No power loss associated with pure capacitor in ac circuit.
Reason : No current is flowing in this circuit.
- (a) Both Assertion and Reason are correct and Reason is the correct explanation of Assertion.
(b) Both Assertion and Reason are correct, but Reason is not the correct explanation of Assertion.
(c) Assertion is correct but Reason is incorrect.
(d) Assertion is incorrect but Reason is correct.
14. **Assertion :** If a compass needle be kept at magnetic north pole of the earth the compass needle may stay in any direction.
Reason : Dip needle will stay vertical at the north pole of earth.
- (a) Both Assertion and Reason are correct and Reason is the correct explanation of Assertion.
(b) Both Assertion and Reason are correct, but Reason is not the correct explanation of Assertion.
(c) Assertion is correct but Reason is incorrect.
(d) Assertion is incorrect but Reason is correct.



15. **Assertion (A)** : The surface of a conductor is an equipotential surface.
Reason (R) : Conductor allows the flow of charge.
- (a) Both Assertion and Reason are correct and Reason is the correct explanation of Assertion.
 - (b) Both Assertion and Reason are correct, but Reason is not the correct explanation of Assertion.
 - (c) Assertion is correct but Reason is incorrect.
 - (d) Assertion is incorrect but Reason is correct.
16. **Assertion** : A charge, whether stationary or in motion produces a magnetic field around it.
Reason : Moving charges produce only electric field in the surrounding space.
- (a) Both Assertion and Reason are correct and Reason is the correct explanation of Assertion.
 - (b) Both Assertion and Reason are correct, but Reason is not the correct explanation of Assertion.
 - (c) Assertion is correct but Reason is incorrect.
 - (d) Assertion is incorrect but Reason is correct.

SECTION-B

17. Magnetic field lines can be entirely confined with the core of toroid, but not within a straight solenoid, why?
18. A concave lens of refractive index 1.5 is immersed in a medium of refractive index 1.65 what is the nature of the lens?
19. Why are two bulbs lighting the same walls considered as incoherent sources? How do their intensities add up?

OR

When a tiny circular obstacle is placed in the path of light from a distant source, a bright spot is seen at the centre of shadow of the obstacle. Explain.

20. How are infrared waves produced? Why are these referred to as heat waves? Write their one important use.
21. Is the steady electric current the only source of magnetic field? Justify your answer.

SECTION-C

22. Distinguish between 'Intrinsic' and 'extrinsic' semiconductors?
23. A charge Q is given to three capacitors C_1 , C_2 and C_3 connected in parallel. Determine the charge on each.
24. How will you explain twinkling of stars?
25. Describe briefly, with the help of a diagram, the role of the two important process involved in the formation of a $p - n$ junction.

Continue on next page.....

[CLICK HERE TO SEE ANSWERS](#)



26. How are electromagnetic waves produced? What is the source of energy of these waves? Write mathematical expressions for electric and magnetic fields of an electromagnetic wave propagating along the z-axis. Write any two important properties of electromagnetic waves.
27. Briefly describe proton-neutron hypothesis of nuclear composition.

OR

What are uncontrolled and controlled chain reactions?

28. Determine the distance of closest approach when an alpha particle of kinetic energy 4.5 MeV strikes a nucleus of $Z = 80$, stops and reverse its direction.

SECTION-D

29. When light from a monochromatic source is incident on a single narrow slit, it gets diffracted and a pattern of alternate bright and dark fringes is obtained on screen, called “Diffraction Pattern” of single slit. In diffraction pattern of single slit, it is found that
- (I) Central bright fringe is of maximum intensity and the intensity of any secondary bright fringe decreases with increase in its order.
- (II) Central bright fringe is twice as wide as any other secondary bright or dark fringe.

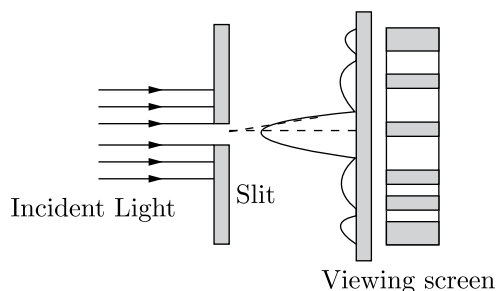

- (i) A single slit of width 0.1 mm is illuminated by a parallel beam of light of wavelength 6000 \AA and diffraction bands are observed on a screen 0.5 m from the slit. The distance of the third dark band from the central bright band is
- (a) 3 mm (b) 1.5 mm
(c) 9 mm (d) 4.5 mm
- (ii) In Fraunhofer diffraction pattern, slit width is 0.2 mm and screen is at 2 m away from the lens. If wavelength of light used is 5000 \AA then the distance between the first minimum on either side the central maximum is
- (a) 10^{-1} m (b) 10^{-2} m
(c) $2 \times 10^{-2} \text{ m}$ (d) $2 \times 10^{-1} \text{ m}$
- (iii) Light of wavelength 600 nm is incident normally on a slit of width 0.2 mm. The angular width of central maxima in the diffraction pattern is (measured from minimum to minimum)
- (a) $6 \times 10^{-3} \text{ rad}$ (b) $4 \times 10^{-3} \text{ rad}$
(c) $2.4 \times 10^{-3} \text{ rad}$ (d) $4.5 \times 10^{-3} \text{ rad}$

Continue on next page.....

CLICK HERE TO INSTALL NODIA APP



- (iv) A diffraction pattern is obtained by using a beam of red light. What will happen, if the red light is replaced by the blue light?
- bands disappear
 - bands become broader and farther apart
 - no change will take place
 - diffraction bands become narrower and crowded together.

OR

- (v) To observe diffraction, the size of the obstacle
- should be $\lambda/2$, where λ is the wavelength.
 - should be of the order of wavelength.
 - has no relation to wavelength.
 - should be much larger than the wavelength.

30. Coulomb's law states that the electrostatic force of attraction or repulsion acting between two stationary point charges is given by

$$F = \frac{1}{4\pi\epsilon_0} \frac{q_1 q_2}{r^2}$$



where F denotes the force between two charges q_1 and q_2 separated by a distance r in free space, ϵ_0 is a constant known as permittivity of free space. Free space is vacuum and may be taken to be air practically. If free space is replaced by a medium, then ϵ_0 is replaced by $(\epsilon_0 k)$ or $(\epsilon_0 \epsilon_r)$ where k is known as dielectric constant or relative permittivity.

- (i) In coulomb's law, $F = k \frac{q_1 q_2}{r^2}$, then on which of the following factors does the proportionality constant k depends?
- Electrostatic force acting between the two charges
 - Nature of the medium between the two charges
 - Magnitude of the two charges
 - Distance between the two charges.
- (ii) Dimensional formula for the permittivity constant ϵ_0 of free space is
- $[ML^{-3}T^4A^2]$
 - $[M^{-1}L^3T^2A^2]$
 - $[M^{-1}L^{-3}T^4A^2]$
 - $[ML^{-3}T^4A^{-2}]$
- (iii) The force of repulsion between two charges of 1 C each, kept 1 m apart in vacuum is
- $\frac{1}{9 \times 10^9} \text{ N}$
 - $9 \times 10^9 \text{ N}$
 - $9 \times 10^7 \text{ N}$
 - $\frac{1}{9 \times 10^{12}} \text{ N}$

Continue on next page.....

CLICK HERE TO SEE ANSWERS



- (iv) Two identical charges repel each other with a force equal to 10 mgwt when they are 0.6 m apart in air. ($g = 10 \text{ m s}^{-2}$). The value of each charge is
- (a) 2 mC (b) $2 \times 10^{-7} \text{ mC}$
(c) 2 nC (d) $2 \mu\text{C}$

OR

- (v) Coulomb's law for the force between electric charges most closely resembles with
- (a) law of conservation of energy
(b) Newton's law of gravitation
(c) Newton's 2nd law of motion
(d) law of conservation of charge

SECTION-E

31. Give postulates of Bohr's theory. Explain hydrogen spectrum on the basis of Bohr's theory.

OR

What is H_α line in the emission spectrum of hydrogen atom obtained? Calculate the frequency of the photon emitted during this transition.

- (i) Define electric intensity.
(ii) Derive an expression for electric intensity at a point situated on the axis of electric dipole.

OR

A regular hexagon of side 10 cm has charge $5 \mu\text{C}$ at each of its vertices. What is the resultant potential at the centre of the hexagon?

32. Discuss the motion of a charged particle in a uniform magnetic field with initial velocity (1) parallel to the field, (2) perpendicular to the magnetic field and (3) at an arbitrary angle with the field direction.

OR

- (i) State Ampere's circuital law. Use this law to obtain the expression for the magnetic field inside an air cored toroid of average radius r , having n turns per unit length and carrying a steady current I .
(ii) An observer to the left of a solenoid of N turns each of cross-section area A observes that a steady current I in it flows in the clockwise direction. Depict the magnetic field lines due to the solenoid specifying its polarity and show that it acts as a bar magnet of magnetic moment $m = NIA$.

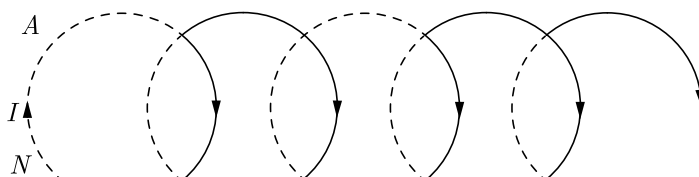

□□□□□□



Sample Paper 06

Class XII 2024-25

Physics

Time: 3 Hours

Max. Marks: 70

General Instructions:

1. There are 33 questions in all. All questions are compulsory.
2. This question paper has five sections: Section A, Section B, Section C, Section D and Section E.
3. All the sections are compulsory.
4. Section A contains sixteen questions, twelve MCQ and four assertion reasoning based of 1 mark each, Section B contains five questions of 2 marks each, Section C contains seven questions of 3 marks each, Section D contains two case study based questions of 4 marks each and Section E contains three long questions of 5 marks each.
5. There is no overall choice. However, an internal choice has been provided in one question in Section B, one question in Section C, one question in each CBQ in Section D and all three questions in Section E. You have to attempt only one of the choices in such questions
6. Use of calculators is not allowed.
7. You may use the following values of physical constants where ever necessary
 - i. $c = 3 \times 10^8$ m/s
 - ii. $m_e = 9.1 \times 10^{-31}$ kg
 - iii. $e = 1.6 \times 10^{-19}$ C
 - iv. $\mu_0 = 4\pi \times 10^{-7}$ Tm A^{-1}
 - v. $h = 6.63 \times 10^{-34}$ Js
 - vi. $\epsilon_0 = 8.854 \times 10^{-12}$ C²N⁻¹m⁻²
 - vii. Avogadro's number = 6.023×10^{23} per gram mole

SECTION-A

1. If a bar magnet is dropped down in an infinitely long vertical copper tube, then the magnet will move continuously
 - (a) Increasing velocity and acceleration
 - (b) Increasing velocity but constant acceleration
 - (c) Decreasing velocity and ultimately comes to rest
 - (d) Increasing velocity and ultimately acquires a constant terminal velocity
2. Which scientist experimentally proved the existence of electromagnetic waves?
 - (a) Marconi
 - (b) Heinrich Rudolf Hertz
 - (c) James Clerk Maxwell
 - (d) Jagdish Chander Bose
3. A circular coil of radius r carries a current I . The magnetic field at its centre is B . At what distance from the centre, on the axis of the coil, the magnetic field will be $B/8$
 - (a) $\sqrt{2} R$
 - (b) $2R$
 - (c) $\sqrt{3} R$
 - (d) $3R$

Continue on next page.....

CLICK HERE TO SEE ANSWERS



4. The voltage V and current I graphs for a conductor at two different temperatures T_1 and T_2 are shown in the figure. The relation between T_1 and T_2 is

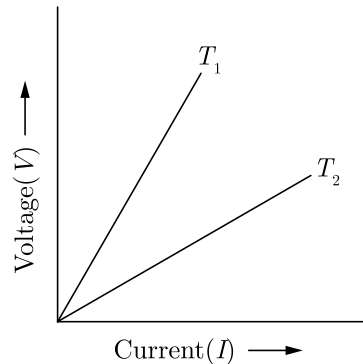

- (a) $T_1 > T_2$ (b) $T_1 \approx T_2$
 (c) $T_1 = T_2$ (d) $T_1 < T_2$
5. Two plates of a parallel plate capacitor are 1 cm apart and potential difference between them is 10 V. The electric field between the plates is
 (a) 10 N-C^{-1} (b) 250 N-C^{-1}
 (c) 500 N-C^{-1} (d) 1000 N-C^{-1}
6. Two coils are placed close to each other. The mutual inductance of the pair of coils depends upon
 (a) Currents in the coils
 (b) Materials of the wires of the coils
 (c) Relative position and orientation of the coils
 (d) Rates at which the currents are changing in the coils
7. What happens if a monochromatic light used in the Young's double slit experiment is replaced by white light?
 (a) No fringes are observed
 (b) All bright fringes become white
 (c) All bright fringes are coloured between violet and red
 (d) Only central fringe is white and all other fringes are coloured
8. An electric current passes through a long straight copper wire. At a distance 5 cm from the straight wire, the magnetic field is B . The magnetic field at 20 cm from the straight wire would be
 (a) $\frac{B}{6}$ (b) $\frac{B}{4}$
 (c) $\frac{B}{3}$ (d) $\frac{B}{2}$

Continue on next page.....

CLICK HERE TO INSTALL NODIA APP



9. An aluminium ring B faces an electromagnet A . Which of the following statement is correct?

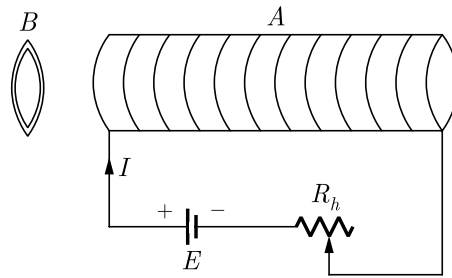

- (a) If I increases, A will repel B
 (b) If I decreases, A will repel B
 (c) If I increases, A will attract B
 (d) Whether I increases or decreases B will not experience any force
10. A particle of mass m and charged q is accelerated through a potential V . The De-Broglie wavelength of the particle will be:
- (a) $\frac{Vh}{\sqrt{2qm}}$ (b) $\frac{q}{\sqrt{2mV}}$
 (c) $\frac{h}{\sqrt{2qmV}}$ (d) $\frac{mh}{\sqrt{2qV}}$
11. The minimum angular momentum of electron in Hydrogen atom will be
- (a) $\frac{h}{\pi} Js$ (b) $\frac{h}{2\pi} Js$
 (c) $h\pi Js$ (d) $2\pi h Js$
12. In the figure, if net force on Q is zero then value of $\frac{Q}{q}$ is:

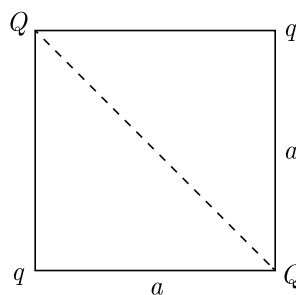

- (a) $\sqrt{2}$ (b) $2\sqrt{2}$
 (c) $\frac{1}{2\sqrt{2}}$ (d) $\frac{1}{\sqrt{2}}$

Continue on next page.....

CLICK HERE TO SEE ANSWERS



13. **Assertion :** Photo-sensitivity of a metal is high if its work function is small.
Reason : Work function = hf_0 where f_0 is the threshold frequency.
- (a) Both Assertion and Reason are correct and the Reason is a correct explanation of the Assertion.
 - (b) Both Assertion and Reason are correct but Reason is not a correct explanation of the Assertion.
 - (c) The Assertion is correct but Reason is incorrect.
 - (d) Both the Assertion and Reason are incorrect.
14. **Assertion :** In Young's experiment, the fringe width for dark fringes is different from that for white fringes.
Reason : In Young's double slit experiment the fringes are performed with a source of white light, then only black and bright fringes are observed.
- (a) Both Assertion and Reason are correct and the Reason is a correct explanation of the Assertion.
 - (b) Both Assertion and Reason are correct but Reason is not a correct explanation of the Assertion.
 - (c) The Assertion is correct but Reason is incorrect.
 - (d) Both the Assertion and Reason are incorrect.
15. **Assertion :** The resistivity of a semi-conductor increases with temperature.
Reason : The atoms of semi-conductor vibrate with larger amplitude as higher temperatures thereby increasing its resistivity.
- (a) Both Assertion and Reason are correct and the Reason is a correct explanation of the Assertion.
 - (b) Both Assertion and Reason are correct but Reason is not a correct explanation of the Assertion.
 - (c) The Assertion is correct but Reason is incorrect.
 - (d) Both the Assertion and Reason are incorrect.
16. Assertion (A) : The minimum distance between an object and its real image formed by a convex lens is $2f$.
Reason (R) : The distance between an object and its real image is minimum when its magnification is two.
- (a) Both Assertion and Reason are correct and the Reason is a correct explanation of the Assertion.
 - (b) Both Assertion and Reason are correct but Reason is not a correct explanation of the Assertion.
 - (c) The Assertion is correct but Reason is incorrect.
 - (d) Both the Assertion and Reason are incorrect.

Continue on next page.....

[CLICK HERE TO INSTALL NODIA APP](#)



SECTION-B

17. You are given two converging lenses of focal length 1.25 cm and 5 cm to design a compound microscope. If it is desired to have a magnification of 30, then find out the separation between the objective and eyepiece.
18. A small magnet of magnetic moment M , is placed at a distance r from the origin O with its axis parallel to X -axis as shown. A small coil, if one turn is placed on the X -axis, at the same distance from the origin, with the axis of the coil coinciding with X -axis. For what value of current in the coil does a small magnetic needle, kept at origin, remains undeflected? What is the direction of current in the coil?

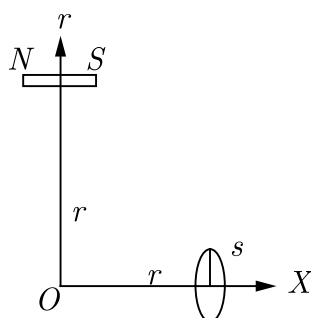

19. What is Einstein's mass-energy equivalence? What is its importance?
20. Draw the voltage-current characteristic curve of a diode and mark its important parameter.
- or**
- Draw $V-I$ characteristics of a $p-n$ junction diode. Answer the following questions, giving reasons:
- (i) Why is the current under reverse bias almost independent of the applied potential upto a critical voltage?
- (ii) Why does the reverse current show a sudden increase at the critical voltage?
21. A capacitor of capacitance C is being charged by connecting it across a DC source along with an ammeter. Will the ammeter show a momentary deflection during the process of charging? If so, how would you explain this momentary deflection and the resulting continuity of current in the circuit? Write the expression for the current inside the capacitor.

Continue on next page.....

CLICK HERE TO SEE ANSWERS

SECTION-C

22. A capacitor C , a variable resistor R and a bulb B are connected in series to the AC mains in the circuit as shown in the figure. The bulb glows with some brightness. How will the glow of the bulb change if (i) a dielectric slab is introduced between the plates of the capacitor keeping resistance R to be the same (ii) the resistance R is increased keeping the same capacitance?

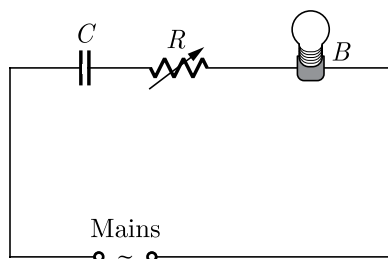

23. Draw a graph showing the variation of intensity against the position x on the screen in Young double slit experiment.
24. Two point charges having equal charges separated by 1 m distance experience a force of 8 N. What will be the force experienced by them, if they are held in water, at the same distance? (Given: $K_{\text{water}} = 80$)
25. Give some points of similarities and differences between Biot-Savart law for the magnetic field and Coulomb's law for the electrostatic field.
26. The electron in a given Bohr orbit has a total energy of -1.5 eV . Calculate its
- kinetic energy
 - potential energy
 - wavelength of radiation emitted, when this electron makes a transition to the ground state.
- [Given, energy in the ground state $= -13.6 \text{ eV}$ and Rydberg's constant $= 1.09 \times 10^7 \text{ m}^{-1}$]
27. A proton and an alpha particle are accelerated through the same potential. Which one of the two has (i) greater value of de-Broglie wavelength associated with it and (ii) less kinetic energy? Give reason to justify your answer.

or

- Give a brief description of the basic elementary process involved in the photoelectric emission in Einstein's picture.
- When a photosensitive material is irradiated with the light of frequency ν , the maximum speed of electrons is given by V_{max} . A plot of V_{max}^2 is found to vary with frequency ν as shown in the figure. Use Einstein's photoelectric equation to find the expressions for (i) Planck's constant and (ii) work function of the given photosensitive material, in terms of the parameters l , n and mass m of the electron.

CLICK HERE TO INSTALL NODIA APP



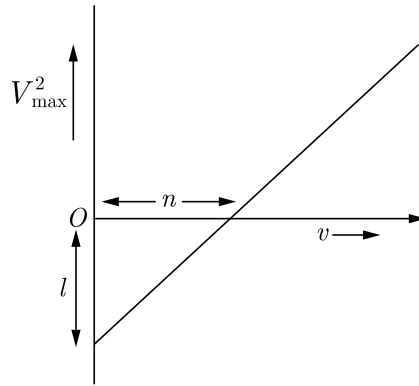

28. A horizontal conducting rod 10 m long extending from east to west is falling with a speed 5.0 ms^{-1} at right angle to the horizontal component of the Earth's magnetic field, $0.3 \times 10^{-4} \text{ Wb} - \text{m}^{-2}$. Find the instantaneous value of the emf induced in the rod.

SECTION-D

Case Study Based Questions.

Read the following paragraph and answer the questions that follow.

29. When the diode is forward biased, it is found that beyond forward voltage $V = V_k$, called knee voltage, the conductivity is very high. At this value of battery biasing for $p-n$ junction, the potential barrier is overcome and the current increases rapidly with increase in forward voltage. When the diode is reverse biased, the reverse bias voltage produces a very small current about a few micro-amperes which almost remains constant with bias. This small current is reverse saturation current.
- (i) In which of the following figures, the $p-n$ diode is forward biased.

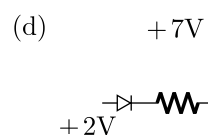
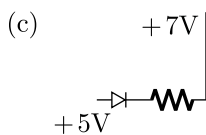
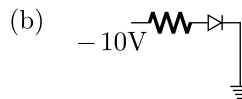
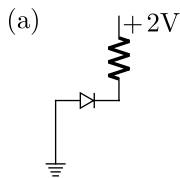

- (ii) Based on the V - I characteristics of the diode, we can classify diode as
 (a) bi-directional device (b) ohmic device
 (c) non-ohmic device (d) passive element
- (iii) The V - I characteristic of a diode is shown in the figure. The ratio of forward to reverse bias resistance is

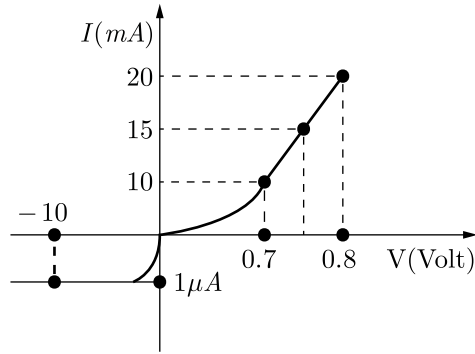

- (a) 100 (b) 10^6
 (c) 10 (d) 10^{-6}

- (iv) In the case of forward biasing of a p - n junction diode, which one of the following figures correctly depicts the direction of conventional current (indicated by an arrow mark)?

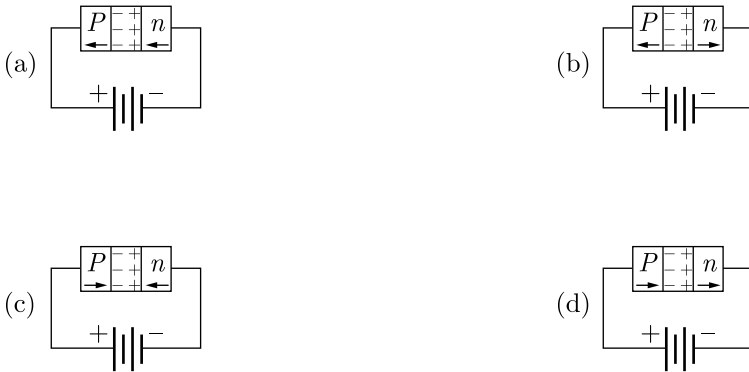

OR

If an ideal junction diode is connected as shown, then the value of the current I is

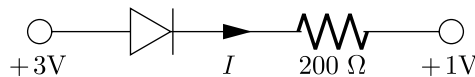

- (a) 0.013 A (b) 0.02 A
 (c) 0.01 A (d) 0.1 A

Continue on next page.....

CLICK HERE TO INSTALL NODIA APP

30. A convex or converging lens is thicker at the centre than at the edges. It converges a parallel beam of light on refraction through it. It has a real focus. Convex lens is of three types : (i) Double convex lens (ii) Plano-convex lens (iii) Concavo-convex lens. Concave lens is thinner at the centre than at the edges. It diverges a parallel beam of light on refraction through it. It has a virtual focus.
- (i) A point object O is placed at a distance of 0.3 m from a convex lens (focal length 0.2 m) cut into two halves each of which is displaced by 0.0005 m as shown in figure.

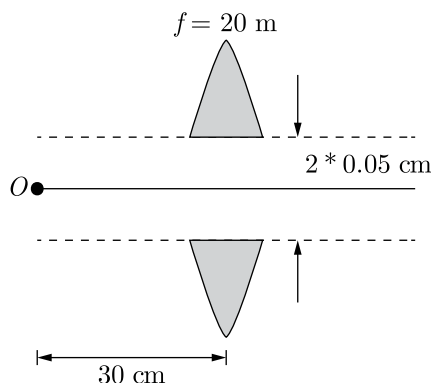

What will be the location of the image?

- (a) 30 cm right of lens
 (b) 60 cm right of lens
 (c) 70 cm left of lens
 (d) 40 cm left of lens
- (ii) Two thin lenses are in contact and the focal length of the combination is 80 cm. If the focal length of one lens is 20 cm, the focal length of the other would be.
 (a) -26.7 cm (b) 60 cm
 (c) 80 cm (d) 20 cm
- (iii) A spherical air bubble is embedded in a piece of glass. For a ray of light passing through the bubble, it behaves like a
 (a) Converging lens
 (b) Diverging lens
 (c) Plano-converging lens
 (d) Plano-diverging lens
- (iv) Lens used in magnifying glass is
 (a) Concave lens
 (b) Convex lens
 (c) Both (a) and (b)
 (d) None of the above

OR

The magnification of an image by a convex lens is positive only when the object is placed

- (a) at its focus F (b) between F and $2F$
 (c) at $2F$ (d) between F and optical centre

Continue on next page.....

CLICK HERE TO SEE ANSWERS



SECTION-E

31. (i) How is a wavefront defined ? Distinguish between a plane wavefront and a spherical wavefront. Using Huygen's constructions draw a figure showing the propagation of a plane wave refracting at a plane surface separating two media. Hence verify Snell's law of refraction.
When a light wave travels from a rarer to a denser medium, the speed decreases. Does it imply reduction its energy ? Explain.
- (ii) When monochromatic light travels from a rarer to a denser medium, explain the following.
(a) Is the frequency of reflected and refracted light same as the frequency of incident light ?
(b) Does the decrease in speed imply a reduction in the energy carried by light wave ?

or

- (i) In Young's double slit experiment, two slits are 1 mm apart and the screen is placed 1 m away from the slits. Calculate the fringe width when light of wavelength 500 nm is used.
- (ii) What should be the width of each slit in order to obtain 10 maxima of the double slits pattern within the central maximum of the single slit pattern ?
- (iii) The intensity at the central maxima in Young's double slit experiment is I_0 . Find out the intensity at a point where the path difference is $\frac{\lambda}{6}$, $\frac{\lambda}{4}$ and $\frac{\lambda}{3}$.
32. A slab of material of dielectric constant K has the same area as that of the plates of a parallel plate capacitor but has the thickness $d/2$, where d is the separation between the plates. Find out the expression for its capacitance when the slab is inserted between the plates of the capacitor.

or

- (i) Define capacitance of a capacitor.
- (ii) Derive expression for stored energy between plates of parallel plate capacitor. Show that energy-density between plates of the capacitor can be expressed as $1/2 \epsilon_0 E^2$, when E = Electric field between plates.
33. (i) Derive an expression for the current density in terms of the drift speed of electrons.
(ii) Derive Ohm's law on the basis of the theory of electron drift.
(iii) Derive an expression for the resistivity of a conductor in terms of number density of free electrons and relaxation time.

or

A 100 W bulb B_1 and two 60 W bulbs B_2 and B_3 , are connected to a 250 V source as shown in the figure. Now W_1 , W_2 and W_3 are the output powers of the bulbs B_1 , B_2 and B_3 respectively. What is the relation between the output powers of bulbs?

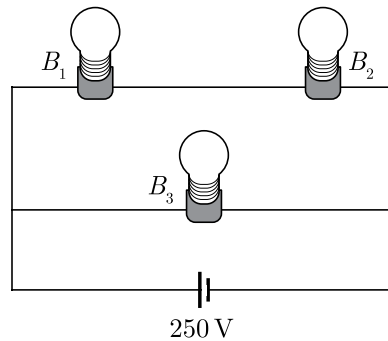

□□□□□□



Sample Paper 07

Class XII 2024-25

Physics

Time: 3 Hours

Max. Marks: 70

General Instructions:

1. There are 33 questions in all. All questions are compulsory.
2. This question paper has five sections: Section A, Section B, Section C, Section D and Section E.
3. All the sections are compulsory.
4. Section A contains sixteen questions, twelve MCQ and four assertion reasoning based of 1 mark each, Section B contains five questions of 2 marks each, Section C contains seven questions of 3 marks each, Section D contains two case study based questions of 4 marks each and Section E contains three long questions of 5 marks each.
5. There is no overall choice. However, an internal choice has been provided in one question in Section B, one question in Section C, one question in each CBQ in Section D and all three questions in Section E. You have to attempt only one of the choices in such questions
6. Use of calculators is not allowed.
7. You may use the following values of physical constants where ever necessary
 - i. $c = 3 \times 10^8$ m/s
 - ii. $m_e = 9.1 \times 10^{-31}$ kg
 - iii. $e = 1.6 \times 10^{-19}$ C
 - iv. $\mu_0 = 4\pi \times 10^{-7}$ Tm A^{-1}
 - v. $h = 6.63 \times 10^{-34}$ Js
 - vi. $\epsilon_0 = 8.854 \times 10^{-12}$ C²N⁻¹m⁻²
 - vii. Avogadro's number = 6.023×10^{23} per gram mole

SECTION-A

1. A spherical drop of capacitance $1 \mu\text{F}$ is broken into eight drops of equal radius. The capacitance of each small drop is
 - (a) $\frac{1}{2} \mu\text{F}$
 - (b) $\frac{1}{4} \mu\text{F}$
 - (c) $\frac{1}{8} \mu\text{F}$
 - (d) $\frac{1}{16} \mu\text{F}$
2. Which of the following rays are not electromagnetic waves ?
 - (a) γ -rays
 - (b) β -rays
 - (c) X-rays
 - (d) heat rays
3. Potential difference between two electrodes of a galvanic cell in an open circuit, is known as
 - (a) current
 - (b) impedance
 - (c) voltage
 - (d) electromotive force

Continue on next page.....

[CLICK HERE TO SEE ANSWERS](#)



4. Quality factor of LCR-circuit having resistance R and inductance L at resonance angular frequency ω is given by
- (a) $\frac{\omega L}{R}$ (b) $\frac{R}{\omega L}$
(c) $\left(\frac{\omega L}{R}\right)^{1/2}$ (d) $\left(\frac{\omega L}{R}\right)^2$
5. A uniform electric field and a uniform magnetic field are acting along the same direction in a certain region. If an electron is projected along the direction of the fields with a certain velocity, then
- (a) its velocity will increase (b) its velocity will decrease
(c) it will turn towards left (d) it will turn towards right
6. Permittivity of free space is.
- (a) $9 \times 10^9 \text{ mF}^{-1}$ (b) $1.6 \times 10^{-19} \text{ C}$
(c) $8.85 \times 10^{-12} \text{ Fm}^{-1}$ (d) $8.85 \times 10^{-9} \text{ Fm}^{-1}$
7. In photoelectric effect the maximum kinetic energy of emitted electron depends on
- (a) wavelength (b) frequency
(c) intensity (d) work function
8. If a diamagnetic substance is brought near north or south pole of a bar magnet, then it is
- (a) attracted by the poles
(b) repelled by the poles
(c) attracted by the north pole and repelled by the south pole
(d) repelled by the north pole and attracted by the south pole
9. The total energy of an electron in the first excited state of hydrogen atom is about -3.4 eV . Its kinetic energy in this state is
- (a) -3.4 eV (b) 3.4 eV
(c) -6.8 eV (d) 6.8 eV
10. A 2 m long solenoid with radius 2 cm and 2000 turns has a another solenoid of 1000 turns wound closely near its mid-point. The mutual inductance of solenoids is
- (a) 0.8 mH (b) 1.6 mH
(c) 3.2 mH (d) 6.4 mH
11. Interference takes place due to change in
- (a) velocity (b) intensity
(c) amplitude (d) phase difference

Continue on next page.....

CLICK HERE TO INSTALL NODIA APP

12. The angle of a prism is 60° . If green light of refractive index 1.5 passes through it, the angle of deviation will be
- (a) 30° (b) 40°
(c) 50° (d) 60°
13. **Assertion :** A concave mirror and convex lens both have the same focal length in air. When they are submerged in water, they will have same focal length.
Reason : The refractive index of water is smaller than the refractive index of air.
- (a) Both Assertion and Reason are correct and Reason is the correct explanation of Assertion.
(b) Both Assertion and Reason are correct, but Reason is not the correct explanation of Assertion.
(c) Assertion is correct but Reason is incorrect.
(d) Assertion is incorrect but Reason is correct.
14. **Assertion (A) :** Newton's rings are formed in the reflected system. When the space between the lens and the glass plate is filled with a liquid of refractive index greater than that of glass, the central spot of the pattern is dark.
Reason (R) : The reflections in Newton's ring cases will be from a denser to a rarer medium and the two interfering rays are reflected under similar conditions.
- (a) Both Assertion and Reason are correct and Reason is the correct explanation of Assertion.
(b) Both Assertion and Reason are correct, but Reason is not the correct explanation of Assertion.
(c) Assertion is correct but Reason is incorrect.
(d) Assertion is incorrect but Reason is correct.
15. **Assertion :** A famous painting was painted by not using brush strokes in the usual manner, but rather a myriad of small colour dots. In this painting the colour you see at any given place on the painting changes as you move away.
Reason : The angular separation of adjacent dots changes with the distance from the painting.
- (a) Both Assertion and Reason are correct and Reason is the correct explanation of Assertion.
(b) Both Assertion and Reason are correct, but Reason is not the correct explanation of Assertion.
(c) Assertion is correct but Reason is incorrect.
(d) Assertion is incorrect but Reason is correct.
16. **Assertion :** Magnetic Resonance Imaging (MRI) is a useful diagnostic tool for producing images of various parts of human body.
Reason : Protons of various tissues of the human body play a role in MRI.
- (a) Both Assertion and Reason are correct and Reason is the correct explanation of Assertion.
(b) Both Assertion and Reason are correct, but Reason is not the correct explanation of Assertion.
(c) Assertion is correct but Reason is incorrect.
(d) Assertion is incorrect but Reason is correct.

Continue on next page.....

[CLICK HERE TO SEE ANSWERS](#)



SECTION-B

17. What is transformer? What do you mean by its efficiency?
18. What is the amount of work done in moving a point charge Q around a circular arc of radius r at the centre of which another point charge q is located?
19. Why does a paramagnetic sample displays greater magnetism when cooled?
20. What is total internal reflection? What are the conditions for it?

OR

A concave mirror and a convex lens are held in water. What change, if any, do you expect to find in the focal length of either?

21. Why alloys like constantan or manganin are used for making standard resistors?

SECTION-C

22. Figure shows a ray of light passing through a prism. If the refracted ray QR is parallel to the base BC , show that
- (i) $r_1 = r_2 = \frac{A}{2}$ and
- (ii) Angle of minimum deviation, $D_m = 2i - A$

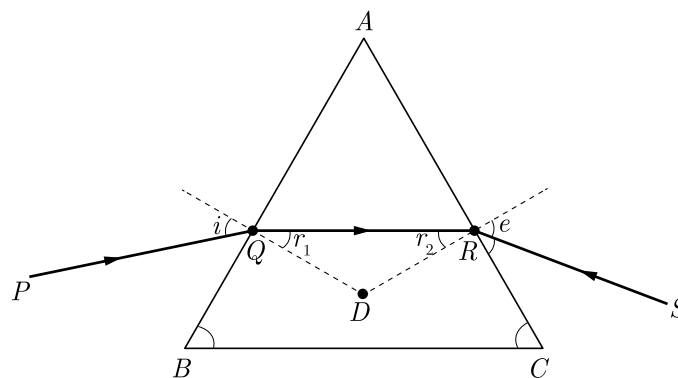

Continue on next page.....

CLICK HERE TO INSTALL NODIA APP



23. In the Rutherford scattering experiment, the distance of closest approach for an α -particles is d_0 . If α -particles is replaced by a proton, then how much kinetic energy in comparison to α -particle will be required to have the same distance of closest approach d_0 ?
24. What is a continuous charge distribution? How can we calculate the force on a point charge q due to a continuous charge distribution?
25. State the rules to find the direction of force on a charge moving in a perpendicular magnetic field.
26. The radionuclide $^{11}_6\text{C}$ decays according to $^{11}_6\text{C} \longrightarrow ^{11}_5\text{B} + e^- + \nu + Q, T_{1/2} = 20.3\text{min}$ The maximum energy of the emitted positron is 0.960 MeV. Given the mass values.

$$m(^{11}_6\text{C}) = 11.0114344\text{ u and}$$

$$m(^{11}_5\text{B}) = 11.009305\text{ u}$$

Calculate Q and compare it with maximum energy of the positron emitted.

27. In Young's double slit experiment, the separation of slits is doubled and the distance of the slits and screen is halved. How will it affect the fringe width?

OR

A slit or an aperture diffracts light. Even then we say light travels in a straight line and ray optic is valid. Comment.

28. The $V - I$ characteristic of a silicon diode is as shown in the figure. Calculate the resistance of the diode at
- (i) $I = 15\text{ mA}$
- (ii) $V = -10\text{ V}$.

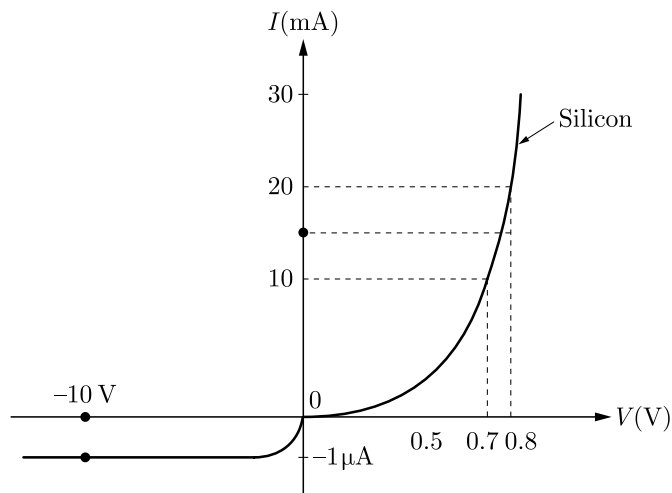

Continue on next page.....

CLICK HERE TO SEE ANSWERS



SECTION-D

Case Study Based Questions.

Read the following paragraph and answer the questions that follow.

29. Smallest charge that can exist in nature is the charge of an electron. During friction it is only the transfer of electrons which makes the body charged. Hence net charge on any body is an integral multiple of charge of an electron [1.6×10^{-19} C] i.e.

$$q = \pm ne$$

where $n = 1, 2, 3, 4, \dots$

$$\begin{array}{c} +2e \\ -3e \end{array} = -e \qquad \begin{array}{c} +10e \\ +5e \end{array} = 15e$$

Hence no body can have a charge represented as $1.1e$, $2.7e$, $3/5e$, etc.

Recently, it has been discovered that elementary particles such as protons or neutrons are composed of more elemental units called quarks.

- (i) Which of the following properties is not satisfied by an electric charge?
- Total charge conservation
 - Quantization of charge
 - Two types of charge.
 - Circular line of force
- (ii) Which one of the following charges is possible?
- 5.8×10^{-18} C
 - 3.2×10^{-18} C
 - 4.5×10^{-19} C
 - 8.6×10^{-19} C
- (iii) If a charge on a body is 1 nC, then how many electrons are present on the body ?
- 6.25×10^{27}
 - 1.6×10^{19}
 - 6.25×10^{28}
 - 6.25×10^9
- (iv) If a body gives out 10^9 electrons every second, how much time is required to get a total charge of 1 C from it?
- 190.19 years
 - 150.12 years
 - 198.19 years
 - 188.21 years

Continue on next page.....

CLICK HERE TO INSTALL NODIA APP



OR

A polythene piece rubbed with wool is found to have a negative charge of 3.2×10^{-7} C. Calculate the number of electrons transferred.

- (a) 2×10^{12}
- (b) 3×10^{12}
- (c) 2×10^{14}
- (d) 3×10^{14}

30. The phenomenon of bending of light around the sharp corners and the spreading of light within the geometrical shadow of the opaque obstacles is called diffraction of light. The light thus deviates from its linear path. The deviation becomes much more pronounced, when the dimensions of the aperture or the obstacle are comparable to the wavelength of light.

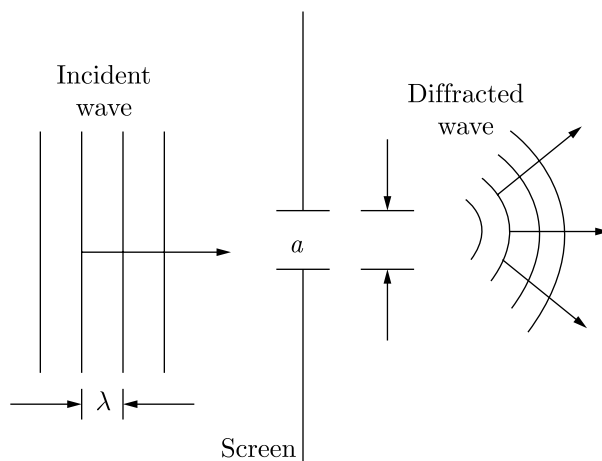

- (i) Light seems to propagate in rectilinear path because
 - (a) its spread is very large
 - (b) its wavelength is very small
 - (c) reflected from the upper surface of atmosphere
 - (c) it is not absorbed by atmosphere
- (ii) In diffraction from a single slit the angular width of the central maxima does not depends on
 - (a) λ of light used
 - (b) width of slit
 - (c) distance of slits from the screen
 - (d) ratio of λ and slit width
- (iii) For a diffraction from a single slit, the intensity of the central point is
 - (a) infinite
 - (b) finite and same magnitude as the surrounding maxima
 - (c) finite but much larger than the surrounding maxima
 - (d) finite and substantially smaller than the surrounding maxima

Continue on next page.....

CLICK HERE TO SEE ANSWERS

- (iv) Resolving power of telescope increases when
- wavelength of light decreases
 - wavelength of light increases
 - focal length of eye-piece increases
 - focal length of eye-piece decreases

OR

In a single diffraction pattern observed on a screen placed at D metre distance from the slit of width d metre, the ratio of the width of the central maxima to the width of other secondary maxima is

- 2 : 1
- 1 : 2
- 1 : 1
- 3 : 1

SECTION-E

31. Obtain expression for the energy density of an electromagnetic wave. In an electromagnetic wave, show that the average energy density of the E field equals the average energy density of the B field.

OR

Considering the case of a parallel plate capacitor being charged, show how one is required to generalise Ampere's circuital law to include the term due to displacement current.

32. With the help of a circuit diagram, explain the working of a junction diode as a full wave rectifier. Draw its input and output waveforms. Which characteristic property makes the junction diode suitable for rectification?

OR

Calculate the value of the resistance R in the circuit shown in the figure so that the current in the circuit is 0.2 A. What would be the potential difference between points A and B ?

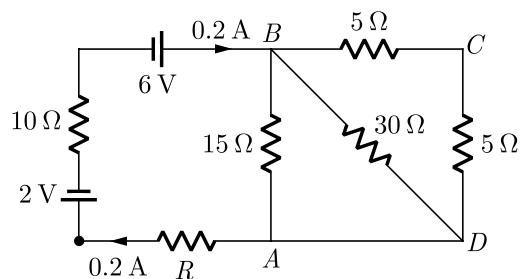

33. What is self-induction? Define self-inductance. Give its units and dimensions.

OR

A helicopter rises vertically with a velocity of 10 m s^{-1} . If helicopter has length of 10 m and horizontal component of earth's magnetic field is $2 \times 10^{-3} \text{ T}$. What is the E.M.F. induced between tip of nose and tail of the helicopter?

□□□□□□

CLICK HERE TO INSTALL NODIA APP



Sample Paper 08

Class XII 2024-25

Physics

Time: 3 Hours

Max. Marks: 70

General Instructions:

1. There are 33 questions in all. All questions are compulsory.
2. This question paper has five sections: Section A, Section B, Section C, Section D and Section E.
3. All the sections are compulsory.
4. Section A contains sixteen questions, twelve MCQ and four assertion reasoning based of 1 mark each, Section B contains five questions of 2 marks each, Section C contains seven questions of 3 marks each, Section D contains two case study based questions of 4 marks each and Section E contains three long questions of 5 marks each.
5. There is no overall choice. However, an internal choice has been provided in one question in Section B, one question in Section C, one question in each CBQ in Section D and all three questions in Section E. You have to attempt only one of the choices in such questions
6. Use of calculators is not allowed.
7. You may use the following values of physical constants where ever necessary
 - i. $c = 3 \times 10^8$ m/s
 - ii. $m_e = 9.1 \times 10^{-31}$ kg
 - iii. $e = 1.6 \times 10^{-19}$ C
 - iv. $\mu_0 = 4\pi \times 10^{-7}$ Tm A^{-1}
 - v. $h = 6.63 \times 10^{-34}$ Js
 - vi. $\epsilon_0 = 8.854 \times 10^{-12}$ C²N⁻¹m⁻²
 - vii. Avogadro's number = 6.023×10^{23} per gram mole

SECTION-A

1. In photoelectric effect the maximum kinetic energy of emitted electron depends on
 - (a) Wavelength
 - (b) Frequency
 - (c) Intensity
 - (d) Work function
2. If a glass rod is immersed in a liquid of the same refractive index, then it will
 - (a) disappear
 - (b) look bent
 - (c) look longer
 - (d) look shorter
3. When two charged capacitors having capacitance and potential C_1, V_1 and C_2, V_2 respectively, are joined with the help of a wire, the common potential will be
 - (a) $C_1 + C_2$
 - (b) $\frac{C_1 V_1 + C_2 V_2}{C_1 + C_2}$
 - (c) $\frac{C_1 V_1 + C_2 V_2}{V_1 + V_2}$
 - (d) $\frac{C_1 V_1^2 + C_2 V_2^2}{V_1^2 + V_2^2}$

Continue on next page.....

CLICK HERE TO SEE ANSWERS



CLICK HERE TO INSTALL NODIA APP



4. The number of Photons of frequency 10^{14} Hz in radiation of 6.62 J will be
(a) 10^{10} (b) 10^{15}
(c) 10^{20} (d) 10^{25}
5. What is the resistance of a 40 W lamp which is lighted as full brilliance by a current of $\frac{1}{3}$ A?
(a) 120Ω (b) 240Ω
(c) 360Ω (d) 480Ω
6. Which of the following does not obey the phenomenon of mutual induction?
(a) Dynamo (b) Transformer
(c) Induction coil (d) Electric heater
7. In Huygen's wave theory, the locus of all points oscillating in the same phase is called a
(a) Ray (b) Vibrator
(c) Wavefront (d) Half period zone
8. In a series combination, $R = 300 \Omega$, $L = 0.9$ H, $C = 2 \mu\text{F}$, $\omega = 1000 \text{ rad} - \text{s}^{-1}$. The impedance of the LCR-circuit is
(a) 400Ω (b) 500Ω
(c) 900Ω (d) 1300Ω
9. An electric dipole consists of a positive and negative charge of $4 \mu\text{C}$ each placed at a distance of 5 mm. The dipole moment is
(a) $2 \times 10^{-8} \text{ C-m}$ (b) $4 \times 10^{-8} \text{ C-m}$
(c) $6 \times 10^{-8} \text{ C-m}$ (d) $8 \times 10^{-8} \text{ C-m}$
10. Two solenoids of the same length having number of turns in the ratio of 2:3 are connected in series. The ratio of magnetic fields at their centres is
(a) 2:1 (b) 3:1
(c) 2:3 (d) 3:2
11. Most of the substance show which of the following magnetic property?
(a) Diamagnetism (b) Paramagnetism
(c) Ferromagnetism (d) Both b and c

Continue on next page.....

CLICK HERE TO SEE ANSWERS

12. When two converging lenses of same focal f are placed in contact, the focal length of the combination is
- (a) f (b) $2f$
(c) $\frac{f}{2}$ (d) $3f$
13. **Assertion :** We cannot think of a magnetic field configuration with three poles.
Reason : A bar magnet does exert a torque on itself due to its own field.
- (a) Both Assertion and Reason are correct and Reason is the correct explanation of Assertion.
(b) Both Assertion and Reason are correct, but Reason is not the correct explanation of Assertion.
(c) Assertion is correct but Reason is incorrect.
(d) Assertion is incorrect but Reason is correct.
14. **Assertion (A) :** Diamond behaves like an insulator.
Reason (R) : There is a large energy gap between valence band and conduction band of diamond.
- (a) Both Assertion and Reason are correct and Reason is the correct explanation of Assertion.
(b) Both Assertion and Reason are correct, but Reason is not the correct explanation of Assertion.
(c) Assertion is correct but Reason is incorrect.
(d) Assertion is incorrect but Reason is correct.
15. **Assertion :** In Young's experiment, the fringe width for dark fringes is different from that for white fringes.
Reason : In Young's double slit experiment the fringes are performed with a source of white light, then only black and bright fringes are observed.
- (a) Both Assertion and Reason are correct and Reason is the correct explanation of Assertion.
(b) Both Assertion and Reason are correct, but Reason is not the correct explanation of Assertion.
(c) Assertion is correct but Reason is incorrect.
(d) Assertion is incorrect but Reason is correct.
16. **Assertion :** In series LCR circuit resonance can take place.
Reason : Resonance takes place if inductance and capacitive resistances are equal and opposite.
- (a) Both Assertion and Reason are correct and Reason is the correct explanation of Assertion.
(b) Both Assertion and Reason are correct, but Reason is not the correct explanation of Assertion.
(c) Assertion is correct but Reason is incorrect.
(d) Assertion is incorrect but Reason is correct.

Continue on next page.....

CLICK HERE TO INSTALL NODIA APP



SECTION-B

17. The current flowing through a pure inductance 2 mH is $I = (15 \cos 300t) A$. What is the (i) r.m.s. and (ii) average value of current for a complete cycle?
18. Define conductivity of a material. Give its SI unit.
19. How does a circular loop carrying current behaves as a magnet?
20. In which situation is there a displacement current but no conduction current ?
21. State the criteria for the phenomenon of total internal reflection of light to take place.

OR

What is the difference between Magnification and Magnifying power?

SECTION-C

22. Draw energy band diagram of n -typed and p -typed semiconductor at temperature $T > 0 K$. Mark the donor and acceptor energy level with their energies.
23. Two equal balls having equal positive charge q coulombs are suspended by two insulating strings of equal length. What would be the effect on the force when a plastic sheet is inserted between the two?
24. When does snell's law fail in refraction?
25. How the size of a nucleus is experimentally determined? Write the relation between the radius and mass number of the nucleus. Show that the density of nucleus is independent of its mass number.
26. In the Rutherford scattering experiment, the distance of closest approach for an α -particle is d_0 . If α -particle is replaced by a proton, then how much kinetic energy in comparison to α -particle will be required to have the same distance of closest approach d_0 ?

Continue on next page.....

CLICK HERE TO SEE ANSWERS



27. Explain why do we need coherent sources to produce interference of light.

OR

Define multiplication factor of a fissionable mass. Give its physical significance.

28. State the Bio-Savart law for the magnetic field due to a current carrying element. Use this law to obtain a formula for magnetic field at the centre of a circular loop of radius R carrying a steady current I . Indicate the direction of the magnetic field.

SECTION-D

29. Gauss's law and Coulomb's law, although expressed in different forms, are equivalent ways of describing the relation between charge and electric field in static conditions. Gauss's law is $\epsilon_0 \phi = q_{\text{encl}}$, when q_{encl} is the net charge inside an imaginary closed surface called Gaussian surface. $\phi = \oint \vec{E} \cdot d\vec{A}$ gives the electric flux through the Gaussian surface. The two equations hold only when the net charge is in vacuum or air.

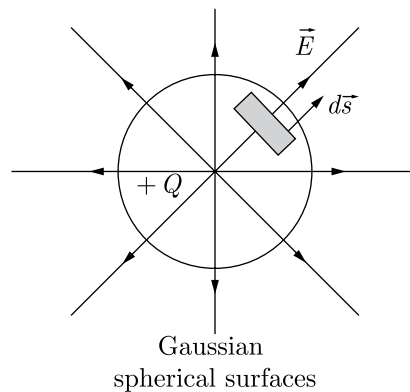

- (i) If there is only one type of charge in the universe, then ($\vec{E} \rightarrow$ Electric field, $d\vec{s} \rightarrow$ Area vector)
- $\oint \vec{E} \cdot d\vec{s} \neq 0$ on any surface
 - $\oint \vec{E} \cdot d\vec{s}$ could not be defined
 - $\oint \vec{E} \cdot d\vec{s} = \infty$ if charge is inside
 - $\oint \vec{E} \cdot d\vec{s} = 0$ if charge is outside,
- $$\oint \vec{E} \cdot d\vec{s} = \frac{q}{\epsilon_0} \text{ if charge is inside}$$
- (ii) What is the nature of Gaussian surface involved in Gauss law of electrostatic ?
- Magnetic
 - Scalar
 - Vector
 - Electrical

Continue on next page.....

CLICK HERE TO INSTALL NODIA APP



- (iii) A charge $10 \mu\text{C}$ is placed at the centre of a hemisphere of radius $R = 10 \text{ cm}$ as shown. The electric flux through the hemisphere (in MKS units) is

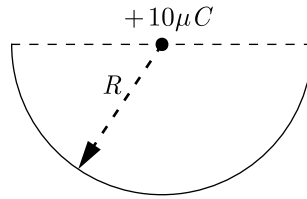

- (a) 20×10^5 (b) 10×10^5
 (c) 6×10^5 (d) 2×10^5
- (iv) The electric flux through a closed surface area S enclosing charge Q is ϕ . If the surface area is doubled, then the flux is
- (a) 2ϕ (b) $\phi/2$
 (c) $\phi/4$ (d) ϕ

OR

A Gaussian surface encloses a dipole. The electric flux through this surface is

- (a) $\frac{q}{\epsilon_0}$ (b) $\frac{2q}{\epsilon_0}$
 (c) $\frac{q}{2\epsilon_0}$ (d) zero

30. Consider the situation shown in figure. The two slits S_1 and S_2 placed symmetrically around the central line are illuminated by monochromatic light of wavelength λ . The separation between the slits is d . The light transmitted by the slits falls on a screen S_0 placed at a distance D from the slits. The slits S_3 is at the central line and the slit S_4 is at a distance from S_3 . Another screen S_c , is placed a further distance D away from S_c .

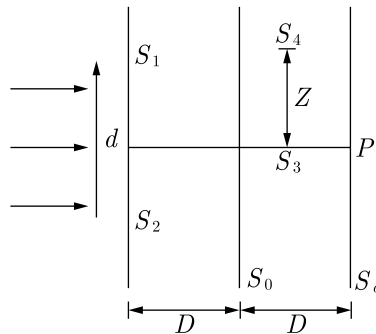

- (i) Find the path difference if $z = \frac{\lambda D}{2d}$
- (a) λ
 (b) $\lambda/2$
 (c) $3/2\lambda$
 (d) 2λ

Continue on next page.....

CLICK HERE TO SEE ANSWERS



- (ii) Find the ratio of the maximum to minimum intensity observed on S_c , if $z = \frac{\lambda D}{d}$
- (a) 4 (b) 2
(c) ∞ (d) 1

- (iii) Two coherent point sources S_1 and S_2 are separated by a small distance d as shown in figure. The fringes obtained on the screen will be

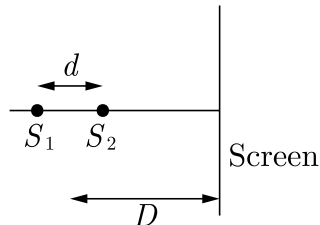

- (a) concentric circles (b) points
(c) straight lines (d) semi-circles
- (iv) In the case of light waves from two coherent sources S_1 and S_2 , there will be constructive interference at an arbitrary point P , if the path difference $S_1P - S_2P$ is
- (a) $(n + \frac{1}{2})\lambda$ (b) $n\lambda$
(c) $7A^2$ (d) $19A^2$

OR

Two monochromatic light waves of amplitudes $3A$ and $2A$ interfering at a point have a phase difference of 60° . The intensity at that point will be proportional to

- (a) $5A^2$ (b) $13A^2$
(c) $7A^2$ (d) $19A^2$

SECTION-E

31. Discuss the inconsistency in Ampere's circuital law. What modification was made by Maxwell in this law?

OR

A parallel plate capacitor is charged to $60 \mu\text{C}$. Due to a radioactive source, the plate loses charge at the rate of $1.8 \times 10^{-8} \text{ C-s}^{-1}$. What is the magnitude of displacement current?

Continue on next page.....

CLICK HERE TO INSTALL NODIA APP



32. Considering the case of a parallel plate capacitor being charged, show how one is required to generalise Ampere's circuital law to include the term due to displacement current.

OR

The $V - I$ characteristic of a silicon diode is as shown in the figure. Calculate the resistance of the diode at

1. $I = 15 \text{ mA}$
2. $V = -10 \text{ V}$.

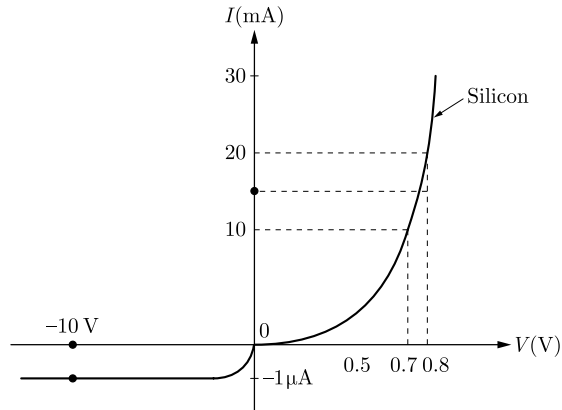

33. Define mutual inductance between a pair of coils. Derive an expression for the mutual inductance of two long coaxial solenoids of same length round one over the other.

OR

In a closed circuit of resistance 10Ω , the linked flux varies with time according to relation $\phi = 6t^2 - 5t + 1$. At $t = 0.25$ second, What is the current (in Ampere) flowing through the circuit?

□□□□□□

Sample Paper 09

Class XII 2024-25

Physics

Time: 3 Hours

Max. Marks: 70

General Instructions:

1. There are 33 questions in all. All questions are compulsory.
2. This question paper has five sections: Section A, Section B, Section C, Section D and Section E.
3. All the sections are compulsory.
4. Section A contains sixteen questions, twelve MCQ and four assertion reasoning based of 1 mark each, Section B contains five questions of 2 marks each, Section C contains seven questions of 3 marks each, Section D contains two case study based questions of 4 marks each and Section E contains three long questions of 5 marks each.
5. There is no overall choice. However, an internal choice has been provided in one question in Section B, one question in Section C, one question in each CBQ in Section D and all three questions in Section E. You have to attempt only one of the choices in such questions
6. Use of calculators is not allowed.
7. You may use the following values of physical constants where ever necessary
 - i. $c = 3 \times 10^8$ m/s
 - ii. $m_e = 9.1 \times 10^{-31}$ kg
 - iii. $e = 1.6 \times 10^{-19}$ C
 - iv. $\mu_0 = 4\pi \times 10^{-7}$ TmA⁻¹
 - v. $h = 6.63 \times 10^{-34}$ Js
 - vi. $\epsilon_0 = 8.854 \times 10^{-12}$ C²N⁻¹m⁻²
 - vii. Avogadro's number = 6.023×10^{23} per gram mole

SECTION-A

1. The specific resistance of a conductor increases with-
 - (a) increase of temperature
 - (b) increase of cross-sectional area
 - (c) decrease on length
 - (d) decrease of cross-sectional area
2. The working of dynamo is based on the principle of
 - (a) heating effect of current
 - (b) electromagnetic induction
 - (c) magnetic induction
 - (d) electric induction
3. Comic rays are
 - (a) high energy radiations
 - (b) low energy radiations
 - (c) ultra high energy radiations
 - (d) very low energy radiations
4. An alternating current is given by: $I = I_1 \cos \omega t + I_2 \sin \omega t$. The root mean square current is given by
 - (a) $\frac{I_1 + I_2}{\sqrt{2}}$
 - (b) $\frac{(I_1 + I_2)^2}{2}$
 - (c) $\sqrt{\frac{I_1^2 + I_2^2}{2}}$
 - (d) $\sqrt{\frac{I_1^2 + I_2^2}{2}}$

[CLICK HERE TO SEE ANSWERS](#)



5. Bright colours exhibited by spider's web exposed to sun light are due to
- (a) diffraction (b) polarisation
(c) interference (d) resolution
6. A plane mirror produces a magnification of
- (a) 0 (b) -1
(c) $+1$ (d) between 0 and $+1$
7. Nuclear atom model is required to explain the results of
- (a) Rydberg's experiment (b) Rutherford's experiment
(c) Thomson's atom model (d) Bohr's frequency condition
8. Permeability μ of a ferromagnetic substance
- (a) $\mu \gg 1$ (b) $\mu = 1$
(c) $\mu < 1$ (d) $\mu = 0$
9. If a current i ampere flows in a long straight thin walled tube, then magnetic induction at any point inside the tube is
- (a) zero (b) infinite
(c) $\frac{2i}{r}$ Tesla (d) $\frac{\mu_0}{4\pi} \cdot \frac{2i}{r}$ Tesla
10. Ampere-hour is unit of
- (a) Power (b) Charge
(c) Energy (d) Potential difference
11. The electrostatic capacity of a capacitor depends upon its
- (a) charge (b) potential
(c) resistance (d) both a and b
12. The de-Broglie wavelength λ depends upon mass m and energy E according to the relation represented as
- (a) $mE^{1/2}$ (b) $m^{1/2}E$
(c) $m^{-1/2}E^{-1/2}$ (d) $m^{-1/2}E^{1/2}$

Continue on next page.....

CLICK HERE TO INSTALL NODIA APP

13. **Assertion :** The stars twinkle while the planets do not.
Reason : the stars are much bigger in size than the planets.
- (a) Both Assertion and Reason are correct and Reason is the correct explanation of Assertion.
 - (b) Both Assertion and Reason are correct, but Reason is not the correct explanation of Assertion.
 - (c) Assertion is correct but Reason is incorrect.
 - (d) Assertion is incorrect but Reason is correct.
14. **Assertion :** Environmental damage has increased the amount of ozone in the atmosphere.
Reason : Increase of ozone increases the amount of ultraviolet radiation of earth.
- (a) Both Assertion and Reason are correct and Reason is the correct explanation of Assertion.
 - (b) Both Assertion and Reason are correct, but Reason is not the correct explanation of Assertion.
 - (c) Assertion is correct but Reason is incorrect.
 - (d) Assertion is incorrect but Reason is correct.
15. **Assertion (A) :** Endoscopy involves use of optical fibres to study internal organs.
Reason (R) : Optical fibres are based on phenomena of total internal reflection.
- (a) Both Assertion and Reason are correct and Reason is the correct explanation of Assertion.
 - (b) Both Assertion and Reason are correct, but Reason is not the correct explanation of Assertion.
 - (c) Assertion is correct but Reason is incorrect.
 - (d) Assertion is incorrect but Reason is correct.
16. **Assertion :** A white source of light during interference forms only white and black fringes.
Reason : Width of fringe is inversely proportional to the wavelength of the light used.
- (a) Both Assertion and Reason are correct and Reason is the correct explanation of Assertion.
 - (b) Both Assertion and Reason are correct, but Reason is not the correct explanation of Assertion.
 - (c) Assertion is correct but Reason is incorrect.
 - (d) Assertion is incorrect but Reason is correct.

Continue on next page.....

[CLICK HERE TO SEE ANSWERS](#)



SECTION-B

17. Write two uses of X -rays.
18. Plot a graph showing variation of current versus voltage for the material GaAs.
19. A uniform magnetic field gets modified as shown in the figure, when two specimens X and Y are placed in it.

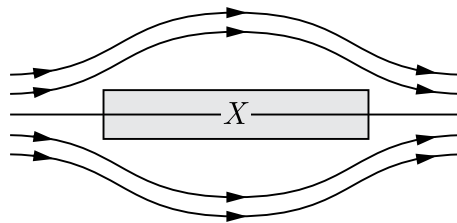

(a)

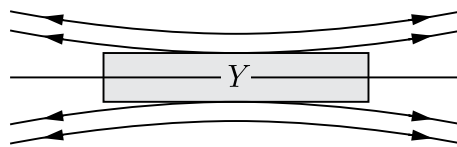

(b)

20. Why does thermionic emission take place from a metal surface only?

OR

Write the relationship of de-Broglie wavelength λ associated with a particle of mass m in terms of its kinetic energy E .

21. Draw equipotential surfaces due to a single point charge.

Continue on next page.....

CLICK HERE TO INSTALL NODIA APP



SECTION-C

22. Write the expression for Bohr's radius in hydrogen atom.
23. Explain, polarisation affords a convincing evidence of transverse nature of light.
24. Compare the properties of electric charge and mass which are not similar.
25. Define one tesla using the expression for the magnetic force acting on a particle of charge q moving with velocity \vec{v} in a magnetic field \vec{B} .
26. Distinguish between 'Intrinsic' and 'extrinsic' semiconductors?
27. Name and define the SI and CGS units of magnetic flux. Write the relation between them.
28. Answer the following questions
- Name the electromagnetic waves which are used for the treatment of certain forms of cancer. Write their frequency range.
 - Thin ozone layer on top of stratosphere is crucial for human survival. Why ?
 - Why is the amount of the momentum transferred by the electromagnetic waves incident on the surface so small ?

OR

Answer the following questions :

- Show, by giving a simple example, how electromagnetic waves carry energy and momentum.
- How are microwaves produced ? Why is it necessary in microwaves ovens to select the frequency of microwaves to match the resonant frequency of water molecules ?
- Write two important uses of infrared waves.

Continue on next page.....

CLICK HERE TO SEE ANSWERS



SECTION-D

Case Study Based Questions.

Read the following paragraph and answer the questions that follow.

29. The electron mobility characterises how quickly an electron can move through a metal of semiconductor when pulled by an electric field. There is an analogous quality for holes, called hole mobility. A block of pure silicon at 300 K has a length of 10 cm and an area of 1.0 cm^2 . A battery of emf 2 V is connected across it. The mobility of electron is $0.14 \text{ m}^2\text{V}^{-1}\text{s}^{-1}$ and their number density is $1.5 \times 10^{16} \text{ m}^{-3}$. The mobility of holes is $0.05 \text{ m}^2\text{V}^{-1}\text{s}^{-1}$.

(i) The electron current is

- (a) $6.72 \times 10^{-4} \text{ A}$
- (b) $6.72 \times 10^{-5} \text{ A}$
- (c) $6.72 \times 10^{-6} \text{ A}$
- (d) $6.72 \times 10^{-7} \text{ A}$

(ii) The hole current is

- (a) $2.0 \times 10^{-7} \text{ A}$
- (b) $2.2 \times 10^{-7} \text{ A}$
- (c) $2.4 \times 10^{-7} \text{ A}$
- (d) $2.6 \times 10^{-7} \text{ A}$

(iii) The number density of donor atoms which are to be added up to pure silicon semiconductor to produce an *n*-type semiconductor of conductivity $6.4 \Omega^{-1}\text{cm}^{-1}$ is approximately (neglect the contribution of holes to conductivity)

- (a) $3 \times 10^{22} \text{ m}^{-3}$
- (b) $3 \times 10^{23} \text{ m}^{-3}$
- (c) $3 \times 10^{24} \text{ m}^{-3}$
- (d) $3 \times 10^{21} \text{ m}^{-3}$

(iv) When the given silicon semiconductor is doped with indium, the hole concentration increases to $4.5 \times 10^{23} \text{ m}^{-3}$. The electron concentration in doped silicon is

- (a) $3 \times 10^9 \text{ m}^{-3}$
- (b) $4 \times 10^9 \text{ m}^{-3}$
- (c) $5 \times 10^9 \text{ m}^{-3}$
- (d) $6 \times 10^9 \text{ m}^{-3}$

OR

Pick out the statement which is not correct.

- (a) At a low temperature, the resistance of a semiconductor is very high.
- (b) Movement of holes is restricted to the valence band only.
- (c) Width of the depletion region increases as the forward bias voltage increases in case of a *p-n* junction diode.
- (d) In a forward bias condition, the diode heavily conducts.

CLICK HERE TO INSTALL NODIA APP



30. The lens maker's formula is a relation that connects focal length of a lens to radii of curvature of two surfaces of the lens and refractive index of the material of the lens. It is $\frac{1}{f} = (\mu - 1)\left(\frac{1}{R_1} - \frac{1}{R_2}\right)$, where μ is refractive index of lens material w.r.t. the medium in which lens is held. As $\alpha_v > \alpha_r$, therefore, $f_r > f_v$. Mean focal length of lens for yellow colour is $f = \sqrt{f_r \times f_v}$.
- (i) Focal length of a equiconvex lens of glass $\mu = \frac{3}{2}$ in air is 20 cm. The radius of curvature of each surface is
- (a) 10 cm (b) -10 cm
(c) 20 cm (d) -20 cm
- (ii) A substance is behaving as convex lens in air and concave in water, then its refractive index is
- (a) greater than air but less than water
(b) greater than both air and water
(c) smaller than air
(d) almost equal to water
- (iii) For a thin lens with radii of curvatures R_1 and R_2 , refractive index n and focal length f , the factor $\left(\frac{1}{R_1} - \frac{1}{R_2}\right)$ is equal to
- (a) $\frac{1}{f(n-1)}$ (b) $f(n-1)$
(c) $\frac{(n-1)}{f}$ (d) $\frac{n}{f(n-1)}$
- (iv) A given convex lens of glass ($\mu = \frac{3}{2}$) can behave as concave when it is held in a medium of μ equal to
- (a) 1 (b) $3/2$
(c) $2/3$ (d) $7/4$

OR

The radii of curvature of the surfaces of a double convex lens are 20 cm and 40 cm respectively, and its focal length is 20 cm. What is the refractive index of the material of the lens?

- (a) $5/2$ (b) $4/3$
(c) $5/3$ (d) $4/5$

SECTION-E

31. Define alternating current (AC), its peak value and its R.M.S. value. Derive relation between them after evaluating the expression for R.M.S. value.

OR

Using phaser diagram for a series *LCR* circuit connected to an AC source of voltage $V = V_0 \sin \omega t$, derive the relation for the current flowing in the circuit and the phase angle between the voltage across the resistor and the net voltage in the circuit.

Draw a plot showing the variation of the current I as a function of angular frequency ' ω ' of the applied AC source for the two cases of a series combination of

CLICK HERE TO SEE ANSWERS



- (i) inductance L_1 , Capacitance C_1 and resistance R_1 and
 (ii) inductance L_2 , Capacitance C_2 and resistance R_2 where $R_2 > R_1$

Write the relation between L_1, C_1 and L_2, C_2 at resonance. Which one of the two would be better suited for fine tuning in a receiver set? Give reason.

32. Draw the graph showing the variation of binding energy per nucleon with the mass number for a large number of nuclei $2 < A < 240$. What are the main inferences from the graph? How do you explain the constancy of binding energy in the range $30 < A < 170$ using the property that the nuclear force is short-ranged? Explain with the help of this plot the release of energy in the processes of nuclear fission and fusion.

OR

Distinguish between nuclear fission and fusion. Show how in both these processes energy is released. Calculate the energy release in MeV in the deuterium fusion reaction.

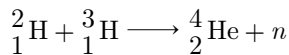

Using the data

$$m({}^2_1\text{H}) = 2.014102 \text{ u}$$

$$m({}^3_1\text{H}) = 3.016049 \text{ u}$$

$$m({}^4_2\text{He}) = 4.002603 \text{ u}$$

$$m_n = 1.008665 \text{ u}$$

$$1\text{u} = 931.5 \frac{\text{MeV}}{c^2}$$

33. What are ohmic and non-ohmic conductors/resistors? State the conditions under which Ohm's law is not obeyed. Give one example of each type.

OR

When 5 V potential difference is applied across a wire of length 0.1 m, the drift speed of electron is 2.5×10^{-4} m/s. If the electron density in the wire is $8 \times 10^{28} \text{ m}^{-3}$, calculate the resistivity of the material of wire.

□□□□□□



Sample Paper 10

Class XII 2024-25

Physics

Time: 3 Hours

Max. Marks: 70

General Instructions:

1. There are 33 questions in all. All questions are compulsory.
 2. This question paper has five sections: Section A, Section B, Section C, Section D and Section E.
 3. All the sections are compulsory.
 4. Section A contains sixteen questions, twelve MCQ and four assertion reasoning based of 1 mark each, Section B contains five questions of 2 marks each, Section C contains seven questions of 3 marks each, Section D contains two case study based questions of 4 marks each and Section E contains three long questions of 5 marks each.
 5. There is no overall choice. However, an internal choice has been provided in one question in Section B, one question in Section C, one question in each CBQ in Section D and all three questions in Section E. You have to attempt only one of the choices in such questions
 6. Use of calculators is not allowed.
 7. You may use the following values of physical constants where ever necessary
 - i. $c = 3 \times 10^8$ m/s
 - ii. $m_e = 9.1 \times 10^{-31}$ kg
 - iii. $e = 1.6 \times 10^{-19}$ C
 - iv. $\mu_0 = 4\pi \times 10^{-7}$ TmA⁻¹
 - v. $h = 6.63 \times 10^{-34}$ Js
 - vi. $\epsilon_0 = 8.854 \times 10^{-12}$ C²N⁻¹m⁻²
 - vii. Avogadro's number = 6.023×10^{23} per gram mole
-

SECTION-A

1. The magnitude of magnetic field at a point due to a current-carrying small element does not depend upon
 - (a) current in the element
 - (b) length of the element
 - (c) diameter of the element
 - (d) distance of the point from the element
2. Which of the following is a non-ohmic resistor?
 - (a) copper
 - (b) aluminium
 - (c) diode-valve
 - (d) none of these
3. The idea of displacement current was introduced by
 - (a) Hertz
 - (b) Ampere
 - (c) Maxwell
 - (d) Farad
4. The ratio of charge to potential of a capacitor is known as its
 - (a) capacitance
 - (b) conductance
 - (c) inductance
 - (d) resistance
5. According to the Rutherford's atomic model, the electrons inside the atom
 - (a) stationary
 - (b) not stationary
 - (c) centralized
 - (d) none of these

CLICK HERE TO SEE ANSWERS



6. Laser light is considered to be coherent as it consists of
(a) divergent beam (b) different wavelengths
(c) uncoordinated wavelength (d) coordinated waves of same wavelength
7. S.I. unit of self-inductance is
(a) coulomb (b) volt
(c) ohm (d) henry
8. When a body is charged, its mass-
(a) increase (b) decrease
(c) remains same (d) may increase or decrease
9. A hotwire ammeter reads 10 A in an AC circuit. The peak value of the current is
(a) 5π A (b) $10\sqrt{2}$ A
(c) $\frac{10}{\sqrt{2}}$ A (d) $\frac{5}{\sqrt{2}}$ A
10. SI unit of power of a lens is
(a) joule (b) dioptre
(c) candela (d) watt
11. Magnetic dipole moment is a vector quantity directed from
(a) South to North Pole (b) North to South Pole
(c) East to West direction (d) West to East direction
12. If the velocity of an electron increases, then its de-Broglie wavelength will
(a) increase (b) decrease
(c) remain the same (d) first a then c
13. **Assertion :** Goggles have zero power.
Reason : Radius of curvature of both sides of lens is same.
(a) Both Assertion and Reason are correct and Reason is the correct explanation of Assertion.
(b) Both Assertion and Reason are correct, but Reason is not the correct explanation of Assertion.
(c) Assertion is correct but Reason is incorrect.
(d) Assertion is incorrect but Reason is correct.
14. **Assertion :** The air bubble shines in water.
Reason : Air bubble in water shines due to refraction of light.
(a) Both Assertion and Reason are correct and Reason is the correct explanation of Assertion.
(b) Both Assertion and Reason are correct, but Reason is not the correct explanation of Assertion.
(c) Assertion is correct but Reason is incorrect.
(d) Assertion is incorrect but Reason is correct.
15. **Assertion :** Dipole oscillations produce electromagnetic waves.
Reason : Accelerated charge produces electromagnetic waves.
(a) Both Assertion and Reason are correct and Reason is the correct explanation of Assertion.
(b) Both Assertion and Reason are correct, but Reason is not the correct explanation of Assertion.
(c) Assertion is correct but Reason is incorrect.
(d) Assertion is incorrect but Reason is correct.



16. **Assertion (A)** : A point charge is brought in an electric field. The field at a nearby point is increase, whatever be the nature of the charge.
Reason (R) : The electric field is independent of the nature of charge.
- (a) Both Assertion and Reason are correct and Reason is the correct explanation of Assertion.
(b) Both Assertion and Reason are correct, but Reason is not the correct explanation of Assertion.
(c) Assertion is correct but Reason is incorrect.
(d) Assertion is incorrect but Reason is correct.

SECTION-B

17. Write expression for magnetic field \vec{B} on axis and equator of a short bar magnet.
18. Write an expression for the pressure exerted by an electromagnetic wave.
19. Can two equipotential surfaces intersect each other ? Justify your answer.
20. What is de-Broglie wave? Write an expression for its wavelength.

OR

A proton and an electron have same kinetic energy. Which one has greater de-Broglie wavelength and why?

21. A 10 V battery of negligible internal assistance is connected across a 200 V battery and a resistance of $38\ \Omega$ as shown in the figure. Find the value of the current circuit.

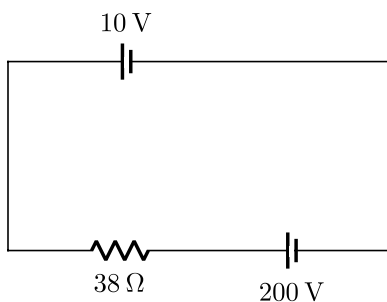

SECTION-C

22. What happens when a forward bias is applied to a $p-n$ -junctions.
23. Two long straight parallel conductors a and b carrying steady currents I_a and I_b respectively are separated by a distance d . Write the magnitude and direction, what is the nature and magnitude of the force between the two conductors?
24. Two nearby narrow slits are illuminated by a single monochromatic source. Name the pattern obtained on the screen. One of the slits is now covered. What is the name of the pattern now obtained on the screen? Write two differences between the patterns obtained in the two cases.

CLICK HERE TO SEE ANSWERS



25. Define the term magnetic flux. Is it a scalar or vector quantity?
26. State Bohr's quantisation condition for defining stationary orbits.
27. Briefly explain how Maxwell was led to predict the existence of electromagnetic waves.

OR

Answer the following questions :

- (i) Name the waves which are produced during radioactive decay of a nucleus. Write their frequency range.
- (ii) Welders wear special glass goggles while working. Why ? Explain.
- (iii) Why are infrared waves often called as heat waves ? Give their one application.
28. Derive the expression for electric field intensity at a point due to a point charge.

SECTION-D

Case Study Based Questions.

Read the following paragraph and answer the questions that follow.

29. A silicon p - n junction diode is connected to a resistor R and a battery of voltage V_B through milliammeter (mA) as shown in figure. The knee voltage for this junction diode is $V_N = 0.7$ V. The p - n junction diode requires a minimum current of 1 mA to attain a value higher than the knee point on the I - V characteristics of this junction diode. Assuming that the voltage V across the junction is independent of the current above the knee point. A p - n junction is the basic building block of many semiconductor devices like diodes. Important process occurring during the formation of a p - n junction are diffusion and drift. In an n -type semiconductor concentration of electrons is more as compared to holes. In a p -type semiconductor concentration of holes is more as compared to electrons.

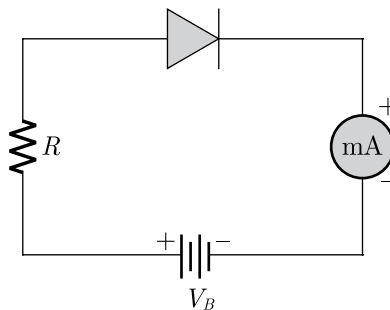

- (i) If $V_B = 5$ V, the maximum value of R so that the voltage V is above the knee point voltage is
- (a) 40 k Ω (b) 4.3 k Ω
 (c) 5.0 k Ω (d) 5.7 k Ω
- (ii) If $V_B = 5$ V, the value of R in order to establish a current to 6 mA in the circuit is
- (a) 833 Ω (b) 717 Ω
 (c) 950 Ω (d) 733 Ω

CLICK HERE TO INSTALL NODIA APP



- (iii) If $V_B = 6\text{ V}$, the power dissipated in the resistor R , when a current of 6 mA flows in the circuit is
 - (a) 30.2 mW
 - (b) 30.8 mW
 - (c) 31.2 mW
 - (d) 31.8 mW
- (iv) When the diode is reverse biased with a voltage of 6 V and $V_{bi} = 0.63\text{ V}$. Calculate the total potential.
 - (a) 9.27 V
 - (b) 6.63 V
 - (c) 5.27 V
 - (d) 0.63 V

OR

Which of the below mentioned statement is false regarding a $p-n$ junction diode?

- (a) Diodes are uncontrolled devices.
- (b) Diodes are rectifying devices.
- (c) Diodes are unidirectional devices.
- (d) Diodes have three terminals.

30. An optical fibre is a thin tube of transparent material that allows light to pass through, without being refracted into the air or another external medium. It make use of total internal reflection. These fibres are fabricated in such a way that light reflected at one side of the inner surface strikes the other at an angle larger than critical angle. Even, if fibre is bent, light can easily travel along the length.

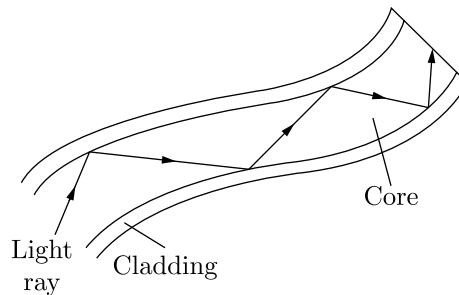

- (i) Which of the following is based on the phenomenon of total internal reflection of light?
 - (a) Sparkling of diamond
 - (b) Optical fibre communication
 - (c) Instrument used by doctors for endoscopy
 - (d) All of these
- (ii) A ray of light will undergo total internal reflection inside the optical fibre, if it
 - (a) goes from rarer medium to denser medium
 - (b) is incident at an angle less than the critical angle
 - (c) strikes the interface normally
 - (d) is incident at an angle greater than the critical angle
- (iii) If in core, angle of incidence is equal to critical angle, then angle of refraction will be
 - (a) 0°
 - (b) 45°
 - (c) 90°
 - (d) 180°
- (iv) In an optical fibre (shown), correct relation for refractive indices of core and cladding is

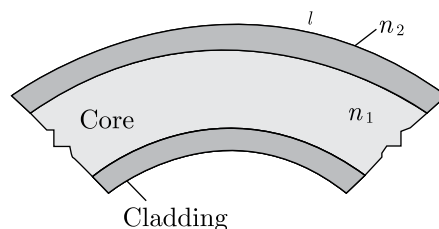

Continue on next page.....

CLICK HERE TO SEE ANSWERS



- (a) $n_1 = n_2$ (b) $n_1 > n_2$
 (c) $n_1 < n_2$ (d) $n_1 + n_2 = 2$

OR

- (v) If the value of critical angle is 30° for total internal reflection from given optical fibre, then speed of light in that fibre is
- (a) $3 \times 10^8 \text{ ms}^{-1}$ (b) $1.5 \times 10^8 \text{ ms}^{-1}$
 (c) $6 \times 10^8 \text{ ms}^{-1}$ (d) $4.5 \times 10^8 \text{ ms}^{-1}$

SECTION-E

31. Mention the important properties of α , β and γ rays.

OR

Explain the construction of a nuclear reactor in detail.

32. Define temperature coefficient of resistivity (α). Distinguish between metals, semiconductor and alloys on the basis of their α values.

OR

Find equivalent capacity between A and B .

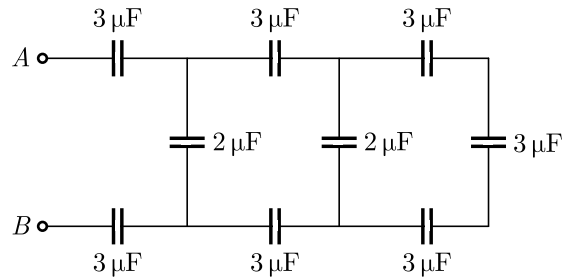

33. What is a choke coil? Discuss its use in AC circuits ?

OR

- (i) An alternating voltage $V = V_m \sin \omega t$ applied to a series $L - C - R$ circuit drives a current given by $I = I_m \sin(\omega t + \phi)$. Deduce an expression for the average power dissipated over a cycle.
- (ii) For circuits used for transporting electric power, a low power factor implies large power loss in transmission. Explain.

□□□□□□



Sample Paper 11

Class XII 2024-25

Physics

Time: 3 Hours

Max. Marks: 70

General Instructions:

1. There are 33 questions in all. All questions are compulsory.
 2. This question paper has five sections: Section A, Section B, Section C, Section D and Section E.
 3. All the sections are compulsory.
 4. Section A contains sixteen questions, twelve MCQ and four assertion reasoning based of 1 mark each, Section B contains five questions of 2 marks each, Section C contains seven questions of 3 marks each, Section D contains two case study based questions of 4 marks each and Section E contains three long questions of 5 marks each.
 5. There is no overall choice. However, an internal choice has been provided in one question in Section B, one question in Section C, one question in each CBQ in Section D and all three questions in Section E. You have to attempt only one of the choices in such questions
 6. Use of calculators is not allowed.
 7. You may use the following values of physical constants where ever necessary
 - i. $c = 3 \times 10^8$ m/s
 - ii. $m_e = 9.1 \times 10^{-31}$ kg
 - iii. $e = 1.6 \times 10^{-19}$ C
 - iv. $\mu_0 = 4\pi \times 10^{-7}$ TmA⁻¹
 - v. $h = 6.63 \times 10^{-34}$ Js
 - vi. $\epsilon_0 = 8.854 \times 10^{-12}$ C²N⁻¹m⁻²
 - vii. Avogadro's number = 6.023×10^{23} per gram mole
-

SECTION-A

1. The mutual inductance, when the magnetic flux changes by 5×10^{-2} Wb and current change by 0.01 A, is
 - (a) 0.2 H
 - (b) 2.5 H
 - (c) 5 H
 - (d) 10 H
2. Which of the following radiations have the least wavelength?
 - (a) X-rays
 - (b) γ -rays
 - (c) β -rays
 - (d) α -rays
3. A 10 μ F capacitor is charged by a battery of e.m.f. 100 V. The electrostatic energy stored in the capacitor is
 - (a) 0.5 J
 - (b) 0.05 J
 - (c) 0.5 mJ
 - (d) 0.05 mJ
4. If a diamagnetic substance is brought near north or south pole of a bar magnet, then it is
 - (a) attracted by the poles
 - (b) repelled by the poles
 - (c) attracted by the north pole and repelled by the south pole
 - (d) repelled by the north pole and attracted by the south pole

[CLICK HERE TO SEE ANSWERS](#)



5. Two insulated charged copper spheres A and B each having charge of 6.5×10^{-7} C are separated by a distance 50 cm. If they are placed in water of dielectric constant 80, then electrostatic force of repulsion between them is
- (a) 1.9×10^{-7} N (b) 3.8×10^{-7} N
(c) 1.9×10^{-4} N (d) 3.8×10^{-4} N
6. A current-carrying coil is placed in a uniform magnetic field of induction B . The current in the coil is I , it has n turns and A is the face area of coil and normal to the surface makes an angle θ with B . The torque experienced by the coil is
- (a) $nIAB\theta$ (b) $nIAB \cos \theta$
(c) $nIAB \sin \theta$ (d) $nIAB \tan \theta$
7. On connecting a battery to the two corners of a diagonal of a square conductor frame of side a , the magnitude of magnetic field at the centre will be
- (a) zero (b) $\frac{\mu_0}{\pi a}$
(c) $\frac{\mu_0}{2\pi a}$ (d) $\frac{2\mu_0}{\pi a}$
8. As the electron in Bohr's orbit of hydrogen atom passes from state $n = 2$ to $n = 1$, the kinetic energy K and the potential energy u change as
- (a) K four-fold and u two-fold
(b) K two-fold and u four-fold
(c) K two-fold and u also two-fold
(d) K four-fold and u also four-fold
9. An infinitely long conducting cylinder is kept parallel to a uniform magnetic field B directed along positive z -axis. The direction of induced current on the surface of cylinder as seen from the z -axis will be
- (a) zero (b) clockwise of the positive z -axis
(c) along the magnetic field (d) anticlockwise of the positive z -axis
10. The phenomenon of diffraction can be treated as the phenomenon of interference, if the number of coherent sources are
- (a) one (b) two
(c) zero (d) infinite
11. A steady current flows in a metallic conductor of non-uniform cross-section. Which of the following quantity is constant along the conductor?
- (a) current (b) drift speed
(c) current density (d) none of these
12. The kinetic energy of an electron, which is accelerated in the potential difference of 100 V is
- (a) 1.6×10^{-17} J (b) 1.6×10^{-14} J
(c) 1.6×10^{-10} J (d) 1.6×10^{-8} J



13. **Assertion :** The photoelectrons produced by a monochromatic light beam incident on a metal surface have a spread in their kinetic energies.
Reason : The work function of the metal is its characteristics property.
- Both Assertion and Reason are correct and the Reason is a correct explanation of the Assertion.
 - Both Assertion and Reason are correct but Reason is not a correct explanation of the Assertion.
 - The Assertion is correct but Reason is incorrect.
 - Both the Assertion and Reason are incorrect.
14. **Assertion (A) :** Charging is due to transfer of electrons.
Reason (R) : Mass of a body decreases slightly when it is negatively charged.
- Both Assertion and Reason are correct and the Reason is a correct explanation of the Assertion.
 - Both Assertion and Reason are correct but Reason is not a correct explanation of the Assertion.
 - The Assertion is correct but Reason is incorrect.
 - Both the Assertion and Reason are incorrect.
15. **Assertion :** The number of electrons in a *p*-type silicon semiconductor is less than the number of electrons in a pure silicon semiconductor at room temperature.
Reason : It is due to law of mass action.
- Both Assertion and Reason are correct and the Reason is a correct explanation of the Assertion.
 - Both Assertion and Reason are correct but Reason is not a correct explanation of the Assertion.
 - The Assertion is correct but Reason is incorrect.
 - Both the Assertion and Reason are incorrect.
16. **Assertion :** Standard optical diffraction gratings can not be used for discriminating between X-ray wavelength.
Reason : The grating spacing is not of the order of X-ray wavelengths.
- Both Assertion and Reason are correct and the Reason is a correct explanation of the Assertion.
 - Both Assertion and Reason are correct but Reason is not a correct explanation of the Assertion.
 - The Assertion is correct but Reason is incorrect.
 - Both the Assertion and Reason are incorrect.

SECTION-B

17. The velocity of light in a liquid is $1.5 \times 10^8 \text{ ms}^{-1}$ and in air, it is $3 \times 10^8 \text{ ms}^{-1}$. If a ray of light passes from this liquid into air, calculate the value of critical angle.
18. Out of electric field vector \vec{E} and magnetic field vector \vec{B} in an electromagnetic wave, which is more effective and why?
19. 1. How does a diamagnetic material behave when it is cooled to very low temperature?
2. Why does a paramagnetic sample display greater magnetisation when cooled? Explain.

Continue on next page.....

[CLICK HERE TO SEE ANSWERS](#)



20. Name the important process that occurs during the formation of a $p-n$ junction. Explain briefly, with the help of a suitable diagram, how a $p-n$ junction is formed. Define the term 'barrier potential'.

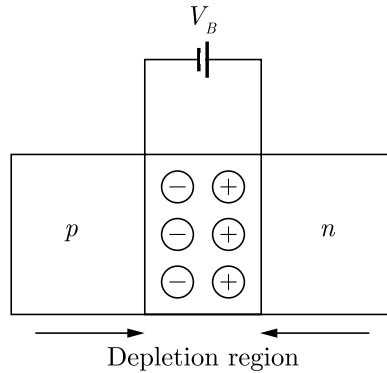

OR

Distinguish between an intrinsic semiconductor and a p -type semiconductor. Give reason why a p -type semiconductor crystal is electrically neutral, although $n_h \gg n_e$.

21. He_2^3 and He_1^3 nuclei have the same mass number. Do they have the same binding energy?

SECTION-C

22. An electric dipole is placed in a uniform electric field E with its dipole moment p parallel to the field. Find:
- The work done in turning the dipole till its dipole moment points in the direction opposite to E .
 - The orientation of the dipole for which the torque acting on it becomes maximum.
23. Using de-Broglie's hypothesis, explain with the help of a suitable diagram, Bohr's second postulate of quantization of energy levels in a hydrogen atom.
24. Show that a tangent galvanometer measures that current with maximum accuracy which produces 45° deflection.
25. A wheel with 8 metallic spokes each 20 cm long is rotated with a speed of 120 rev/min in a plane normal to the horizontal component of the Earth's magnetic field. The Earth's magnetic field at the plane is 0.4 G and the angle of dip is 60° . Calculate the emf induced between the axle and the rim of the wheel. How will the value of emf be affected if the number of spokes were increased?
26. (i) When an AC source is connected to an ideal capacitor, then show that the average power supplied by the source over a complete cycle is zero.
 (ii) A lamp is connected in series with a capacitor. Predict your observations when the system is connected first across a DC and then an AC source. What happens in each case if the capacitance of the capacitor is reduced?



27. Define the term “cut off frequency” in photoelectric emission. The threshold frequency of a metal is f . When the light of frequency $2f$ is incident on the metal plate, the maximum velocity of photoelectrons is v_1 . When the frequency of the incident radiation is increased to $5f$, the maximum velocity of photoelectrons is v_2 . Find the ratio $v_1 : v_2$.

OR

Write Einstein’s photoelectric equation. State clearly the three salient features observed in photoelectric effect which can explain on the basis of this equation.

The maximum kinetic energy of the photoelectrons gets doubled when the wavelength of light incident on the surface changes from λ_1 to λ_2 . Derive the expressions to the threshold wavelength λ_0 and work function for the metal surface.

28. In Young’s double slit experiment, the slits are 0.2 mm apart and the screen is 1.5 m away. It is observed that the distance between the central bright fringe and fourth dark fringe is 1.8 cm. Find the wavelength of light used.

SECTION-D

Case Study Based Questions.

Read the following paragraph and answer the questions that follow.

29. Light emitting diode is a photoelectric device which converts electrical energy into light energy. It is a heavily doped p - n junction diode which under forward biased emits spontaneous radiation. The general shape of the I - V characteristics of an LED is similar to that of a normal p - n junction diode, as shown. The barrier potentials are much higher and slightly different for each colour.

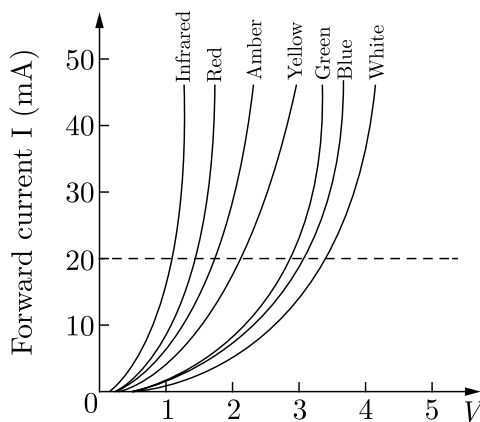

- (i) The I - V characteristic of an LED is

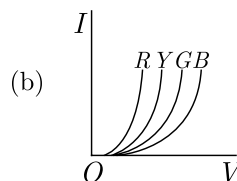
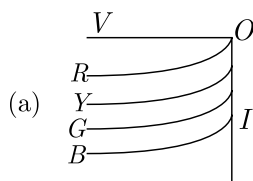

Continue on next page.....

CLICK HERE TO SEE ANSWERS



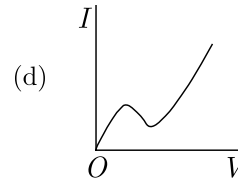
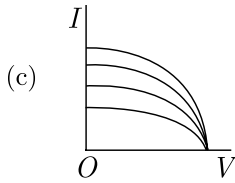

(ii) The schematic symbol of light emitting diode is (LED)

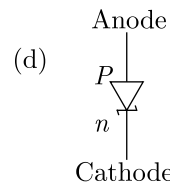
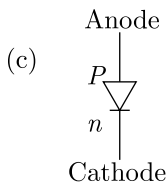
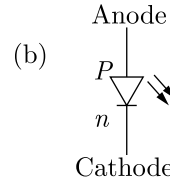
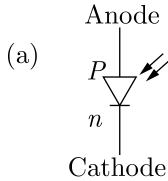

(iii) An LED is constructed from a p - n junction based on a certain Ga-As-P semiconducting material whose energy gap is 1.9 eV. Identify the colour of the emitted light.

- (a) Blue (b) Red
(c) Violet (d) Green

(iv) Which one of the following statement is not correct in the case of light emitting diodes?

- (a) It is a heavily doped p - n junction.
(b) It emits light only when it is forward biased.
(c) It emits light only when it is reverse biased.
(d) The energy of the light emitted is less than the energy gap of the semiconductor used.

OR

The energy of radiation emitted by LED is

- (a) greater than the band gap of the semiconductor used
(b) always less than the band gap of the semiconductor used
(c) always equal to the band gap of the semiconductor used
(d) equal to or less than the band gap of the semiconductor used.

30. Refraction of light is the change in the path of light as it passes obliquely from one transparent medium to another medium. According to law of refraction $\frac{\sin i}{\sin r} = {}^1\mu_2$, where ${}^1\mu_2$ is called refractive index of second medium with respect to first medium. From refraction at a convex spherical surface, we have $\frac{\alpha_2}{v} - \frac{\alpha_1}{u} = \frac{\alpha_2 - \alpha_1}{R}$. Similarly from refraction at a concave spherical surface when object lies in the rarer medium, we have $\frac{\alpha_2}{v} - \frac{\alpha_1}{u} = \frac{\alpha_2 - \alpha_1}{R}$ and when object lies in the denser medium, we have $\frac{\alpha_1}{v} - \frac{\alpha_2}{u} = \frac{\alpha_1 - \alpha_2}{R}$

- (i) Refractive index of a medium depends upon
(a) nature of the medium (b) wavelength of the light used
(c) temperature (d) all of these

Continue on next page.....

CLICK HERE TO INSTALL NODIA APP



- (ii) A ray of light of frequency 5×10^{14} Hz is passed through a liquid. The wavelength of light measured inside the liquid is found to be 450×10^{-9} m. The refractive index of the liquid is
- (a) 1.33 (b) 2.52
(c) 2.22 (d) 0.75
- (iii) A ray of light is incident at an angle of 60° on one face of a rectangular glass slab of refractive index 1.5. The angle of refraction is
- (a) $\sin^{-1}(0.95)$ (b) $\sin^{-1}(0.58)$
(c) $\sin^{-1}(0.79)$ (d) $\sin^{-1}(0.86)$
- (iv) A point object is placed at the centre of a glass sphere of radius 6 cm and refractive index 1.5. The distance of the virtual image from the surface of sphere is
- (a) 2 cm (b) 4 cm
(c) 6 cm (d) 12 cm

OR

In refraction, light waves are bent on passing from one medium to the second medium because in the second medium

- (a) the frequency is different
(b) the co-efficient of elasticity is different
(c) the speed is different
(d) the amplitude is smaller

SECTION-E

31. Two cells of emfs e_1 and e_2 , and internal resistances r_1 and r_2 are connected in parallel between the points A and B . Deduce the expressions for
- the equivalent emf of the combination.
 - the equivalent resistance of the combination.
 - the potential difference between the points A and B .

OR

Obtain an expression for the heat developed in a resistor by the passage of an electric current through it. Hence state Joule's law of heating.

32. (a) A capacitor of capacitance C is charged fully by connecting it to a battery of emf E . It is then disconnected from the battery. If the separation between the plates of the capacitor is now doubled, how will the following change ?
- (i) charge stored by the capacitor.
(ii) field strength between the plates.
(iii) energy stored by the capacitor.
- (b) Explain why, for any configuration, the equipotential surface through a point is normal to the electric field at the point.

Draw a sketch of equipotential surfaces due to a single charge ($-q$), depicting the electric field lines due to the charge.

Continue on next page.....

CLICK HERE TO SEE ANSWERS



OR

Show that the potential energy of a dipole making angle θ with the direction of the field is given by $u(\theta) = -\vec{p} \cdot \vec{E}$. Hence, find out the amount of work done in rotating it from the position of unstable equilibrium to the stable equilibrium.

- 33.** What do you mean by wave front? Write down its type briefly?

OR

Describe diffraction of light due to a single slit. Explain formation of a pattern of fringes obtained on the screen and plot showing variation of intensity with angle θ in single slit diffraction.

□□□□□□



Sample Paper 12

Class XII 2024-25

Physics

Time: 3 Hours

Max. Marks: 70

General Instructions:

1. There are 33 questions in all. All questions are compulsory.
 2. This question paper has five sections: Section A, Section B, Section C, Section D and Section E.
 3. All the sections are compulsory.
 4. Section A contains sixteen questions, twelve MCQ and four assertion reasoning based of 1 mark each, Section B contains five questions of 2 marks each, Section C contains seven questions of 3 marks each, Section D contains two case study based questions of 4 marks each and Section E contains three long questions of 5 marks each.
 5. There is no overall choice. However, an internal choice has been provided in one question in Section B, one question in Section C, one question in each CBQ in Section D and all three questions in Section E. You have to attempt only one of the choices in such questions
 6. Use of calculators is not allowed.
 7. You may use the following values of physical constants where ever necessary
 - i. $c = 3 \times 10^8$ m/s
 - ii. $m_e = 9.1 \times 10^{-31}$ kg
 - iii. $e = 1.6 \times 10^{-19}$ C
 - iv. $\mu_0 = 4\pi \times 10^{-7}$ TmA⁻¹
 - v. $h = 6.63 \times 10^{-34}$ Js
 - vi. $\epsilon_0 = 8.854 \times 10^{-12}$ C²N⁻¹m⁻²
 - vii. Avogadro's number = 6.023×10^{23} per gram mole
-

SECTION-A

1. If the resistivity of an alloy is ρ' and that of its constituent metal is ρ , then
 - (a) $\rho' < \rho$
 - (b) $\rho' > \rho$
 - (c) $\rho' = \rho$
 - (d) none of these
2. When the conductivity of a semiconductor is only due to breaking of covalent bonds, the semiconductor is called
 - (a) extrinsic
 - (b) intrinsic
 - (c) n -type
 - (d) p -type
3. In a ideal transformer, voltage and current in primary are 200 V and 2 A respectively. If voltage in the secondary is 2000 V, then current in the secondary is
 - (a) 20 A
 - (b) 10 A
 - (c) 2 A
 - (d) 0.2 A
4. A charged particle of mass m and charge q travels on a circular path of radius r that is perpendicular to the magnetic field B . The time-taken by the particle to complete one revolution is
 - (a) $\frac{2\pi m}{qB}$
 - (b) $\frac{2\pi qB}{m}$
 - (c) $\frac{2\pi mq}{B}$
 - (d) $\frac{2\pi q^2 B}{m}$

[CLICK HERE TO SEE ANSWERS](#)



5. The magnetic field at a distance r from a short bar magnet is directly proportional to
- (a) r^2 (b) r^{-3}
(c) $r^{2/3}$ (d) r^4
6. The energy stored in a capacitor is actually stored
- (a) between the plates (b) on the positive plate
(c) on the negative plate (d) on the outer surfaces of the plates
7. The value of current, flowing through an inductor of inductance 1 H and having negligible resistance when connected to an AC source of 200 V and 50 Hz, is
- (a) 0.64 A (b) 1.64 A
(c) 2.64 A (d) 3.64 A
8. Two point charges each equal to $2\mu\text{C}$ are 0.5 m apart. If both of them exist inside vacuum, then electrostatic force between them is
- (a) 0.144 N (b) 0.288 N
(c) 1.44 N (d) 2.88 N
9. When the tube length of microscope is increased its magnifying power
- (a) increases (b) decreases
(c) becomes zero (d) remains unchanged
10. A metallic rod of length l is placed normal to the magnetic field B and revolved in a circular path about one of the ends with angular speed ω . The potential difference across the ends will be
- (a) $B\omega^2 l$ (b) $\frac{1}{2}B\omega l$
(c) $\frac{1}{2}B\omega l^2$ (d) $\frac{1}{8}B\omega^3 l$
11. If a photon has velocity c and frequency ν , then which of the following represents its wavelength?
- (a) $\frac{hc}{E}$ (b) $\frac{h\nu}{c}$
(c) $\frac{h\nu}{c^2}$ (d) $h\nu$
12. Which of the following have minimum wavelength?
- (a) γ -rays (b) X-rays
(c) cosmic rays (d) ultra-violet rays
13. **Assertion :** The resistance offered by an inductor in a d.c. circuit is always constant.
Reason : The resistance of inductor in steady state is non-zero.
- (a) Both Assertion and Reason are correct and Reason is the correct explanation of Assertion.
(b) Both Assertion and Reason are correct, but Reason is not the correct explanation of Assertion.
(c) Assertion is correct but Reason is incorrect.
(d) Assertion is incorrect but Reason is correct.



14. **Assertion :** A proton and an alpha particle having the same kinetic energy are moving in circular paths in a uniform magnetic field. The radii of their circular paths will be equal.
Reason : Any two charged particles having equal kinetic energies and entering a region of uniform magnetic field \vec{B} in a direction perpendicular to \vec{B} , will describe circular trajectories of equal radii.
- (a) Both Assertion and Reason are correct and Reason is the correct explanation of Assertion.
(b) Both Assertion and Reason are correct, but Reason is not the correct explanation of Assertion.
(c) Assertion is correct but Reason is incorrect.
(d) Assertion is incorrect but Reason is correct.
15. **Assertion (A) :** In a semiconductor diode, the reverse biased current is due to drift of free electrons and holes.
Reason (R) : The drift of electrons and holes is due to thermal excitations.
- (a) Both Assertion and Reason are correct and Reason is the correct explanation of Assertion.
(b) Both Assertion and Reason are correct, but Reason is not the correct explanation of Assertion.
(c) Assertion is correct but Reason is incorrect.
(d) Assertion is incorrect but Reason is correct.
16. **Assertion :** The ferromagnetic substance do not obey Curie's law.
Reason : At Curie point a ferromagnetic substance start behaving as a paramagnetic substance.
- (a) Both Assertion and Reason are correct and Reason is the correct explanation of Assertion.
(b) Both Assertion and Reason are correct, but Reason is not the correct explanation of Assertion.
(c) Assertion is correct but Reason is incorrect.
(d) Assertion is incorrect but Reason is correct.

SECTION-B

17. A biconvex lens made of a transparent material of refractive index 1.5 is immersed in a water of refractive index 1.33 Will the lens behave as a converging or a converging lens? Give reason.
18. State Ampere's circuit law.
19. How are infrared waves produced ? What role does infrared radiation play in (i) maintaining the Earth's warmth and (ii) physical therapy ?
20. Compare single slit diffraction pattern due to monochromatic light and whit light.

OR

In a single-slit diffraction experiment, the width of the slit is made double the original width. How does this affect the size and intensity of the central diffraction band ?

21. Magnetic field lines show the direction (at every point) along which a small magnetised needle aligns (at the point). Do the magnetic field lines also represent the 'lines of force'?

[CLICK HERE TO SEE ANSWERS](#)



SECTION-C

22. How does electric potential vary from point to point due to a thin charged spherical shell? Draw a graph showing variation of potential with distance.
23. A capacitor made of two parallel plates each of plate area A and separation d , is being charged by an external AC source. Show that the displacement current inside the capacitor is the same as the current charging the capacitor.
24. When does snell's law fail in refraction?
25. Draw the circuit diagram of a half wave rectifier and explain its working.
26. The energy of electron in first Bohr orbit of hydrogen atoms is -13.6 eV. What is energy of electron in its 2nd Bohr-orbit?
27. How is the size of a nucleus estimated? Write the relation between the radius of a nucleus and its mass number.

OR

Define multiplication factor of a fissionable mass. Give its physical significance.

28. Draw energy band diagram of n -typed and p -typed semiconductor at temperature $T > 0$ K. Mark the donor and acceptor energy level with their energies.

SECTION-D

Case Study Based Questions.

Read the following paragraph and answer the questions that follow.

29. When electric dipole is placed in uniform electric field, its two charges experience equal and opposite forces, which cancel each other and hence net force on electric dipole in uniform electric field is zero. However these forces are not collinear, so they give rise to some torque on the dipole. Since net force on electric dipole in uniform electric field is zero, so no work is done in moving the electric dipole in uniform electric field. However some work is done in rotating the dipole against the torque acting on it.

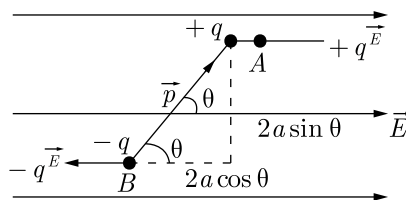

Continue on next page.....

CLICK HERE TO INSTALL NODIA APP



- (i) The dipole moment of a dipole in a uniform external field \vec{E} is \vec{P} . Then the torque $\vec{\tau}$ acting on the dipole is
- (a) $\vec{\tau} = \vec{P} \times \vec{E}$ (b) $\vec{\tau} = \vec{P} \cdot \vec{E}$
 (c) $\vec{\tau} = 2(\vec{P} + \vec{E})$ (d) $\vec{\tau} = (\vec{P} + \vec{E})$
- (ii) An electric dipole consists of two opposite charges, each of magnitude $1.0 \mu\text{C}$ separated by a distance of 2.0 cm . The dipole is placed in an external field of 10^5 NC^{-1} . The maximum torque on the dipole is
- (a) $0.2 \times 10^{-3} \text{ Nm}$ (b) $1 \times 10^{-3} \text{ Nm}$
 (c) $2 \times 10^{-3} \text{ Nm}$ (d) $4 \times 10^{-3} \text{ Nm}$
- (iii) Torque on a dipole in uniform electric field is minimum when θ is equal to
- (a) 0° (b) 90°
 (c) 180° (d) Both (a) and (c)
- (iv) When an electric dipole is held at an angle in a uniform electric field, the net force F and torque τ on the dipole are
- (a) $F = 0, \tau = 0$ (b) $F \neq 0, \tau \neq 0$
 (c) $F = 0, \tau \neq 0$ (d) $F \neq 0, \tau = 0$

OR

An electric dipole of moment p is placed in an electric field of intensity E . The dipole acquires a position such that the axis of the dipole makes an angle θ with the direction of the field. Assuming that the potential energy of the dipole to be zero when $\theta = 90^\circ$, the torque and the potential energy of the dipole will respectively be

- (a) $pE \sin \theta, -pE \cos \theta$ (b) $pE \sin \theta, -2pE \cos \theta$
 (c) $pE \sin \theta, 2pE \cos \theta$ (d) $pE \cos \theta, -pE \sin \theta$

30. In Young's double slit experiment, the width of the central bright fringe is equal to the distance between the first dark fringes on the two sides of the central bright fringe. In given figure below a screen is placed normal to the line joining the two point coherent source S_1 and S_2 . The interference pattern consists of concentric circles.

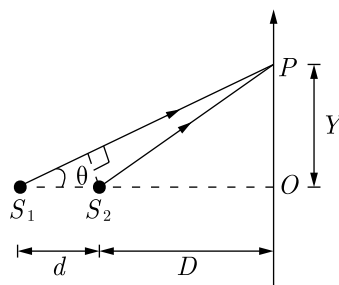

- (i) The optical path difference at P is
- (a) $d \left[1 + \frac{y^2}{2D} \right]$ (b) $d \left[1 + \frac{2D}{y^2} \right]$
 (c) $d \left[1 - \frac{y^2}{2D^2} \right]$ (d) $d \left[2D - \frac{1}{y^2} \right]$

Continue on next page.....

CLICK HERE TO SEE ANSWERS



(ii) Find the radius of the n^{th} bright fringe.

(a) $D\sqrt{1\left(1-\frac{n\lambda}{d}\right)}$

(b) $D\sqrt{2\left(1-\frac{n\lambda}{d}\right)}$

(c) $2D\sqrt{2\left(1-\frac{n\lambda}{d}\right)}$

(d) $D\sqrt{2\left(1-\frac{n\lambda}{2d}\right)}$

(iii) If $d = 0.5 \text{ mm}$, $\lambda = 5000 \text{ \AA}$ and $D = 100 \text{ cm}$, find the value of n for the closest second bright fringe

(a) 888

(b) 830

(c) 914

(d) 998

(iv) The coherence of two light sources means that the light waves emitted have

(a) same frequency

(b) same intensity

(c) constant phase difference

(d) same velocity

OR

The phenomenon of interference is shown by

(a) longitudinal mechanical waves only

(b) transverse mechanical waves only

(c) electromagnetic waves only

(d) all of these

SECTION-E

31. State Bohr's assumption to explain the spectra of hydrogen-like atoms. Obtain an expression for the total energy of an electron revolving in the n^{th} stationary orbit of an atom.

OR

A 12.5 eV electron beam is used to excite a gaseous hydrogen atom at room temperature. Determine the wavelength and the corresponding series of the lines emitted.

32. Define electric flux. State and prove Gauss theorem.

OR

A square of side 1 m, has four charges of $+2 \times 10^{-9} \text{ C}$, $+1 \times 10^{-9} \text{ C}$, $-2 \times 10^{-9} \text{ C}$ and $-3 \times 10^{-9} \text{ C}$ respectively at its corners. What is the resultant potential at the centre of the square?

33. Derive a mathematical expression for the force acting on a current carrying straight conductor kept in a magnetic field. State the rule used to determine the direction of this force. Under what conditions if this force (1) zero and (2) maximum?

OR

Using Ampere's circuital law find an expression for the magnetic field at a point on the axis of a long solenoid with closely wound turns.

□□□□□□



Sample Paper 13

Class XII 2024-25

Physics

Time: 3 Hours

Max. Marks: 70

General Instructions:

- There are 33 questions in all. All questions are compulsory.
- This question paper has five sections: Section A, Section B, Section C, Section D and Section E.
- All the sections are compulsory.
- Section A contains sixteen questions, twelve MCQ and four assertion reasoning based of 1 mark each, Section B contains five questions of 2 marks each, Section C contains seven questions of 3 marks each, Section D contains two case study based questions of 4 marks each and Section E contains three long questions of 5 marks each.
- There is no overall choice. However, an internal choice has been provided in one question in Section B, one question in Section C, one question in each CBQ in Section D and all three questions in Section E. You have to attempt only one of the choices in such questions
- Use of calculators is not allowed.
- You may use the following values of physical constants where ever necessary
 - $c = 3 \times 10^8$ m/s
 - $m_e = 9.1 \times 10^{-31}$ kg
 - $e = 1.6 \times 10^{-19}$ C
 - $\mu_0 = 4\pi \times 10^{-7}$ TmA⁻¹
 - $h = 6.63 \times 10^{-34}$ Js
 - $\epsilon_0 = 8.854 \times 10^{-12}$ C²N⁻¹m⁻²
 - Avogadro's number = 6.023×10^{23} per gram mole

SECTION-A

- The radius of a circular path in which an electron will move, when subjected to a perpendicular uniform magnetic field (B), is
 - $\frac{me}{B}$
 - $\frac{mB}{e}$
 - $\frac{Be}{mv}$
 - $\frac{mv}{Be}$
- Which radiation in sunlight, causes heating effect?
 - ultra violet
 - infra-red
 - visible light
 - all of these
- Which of the following quantity is increased in a step-down transformer?
 - current
 - voltage
 - power
 - frequency
- The magnetic flux through a circuit of resistance R changes by an amount $\Delta\phi$ in a time Δt . The total electric charge Q that passes any point in the circuit during the time Δt is represented by
 - $Q = \frac{\Delta\phi}{\Delta t}$
 - $Q = \frac{\Delta\phi}{R}$
 - $Q = R \cdot \frac{\Delta\phi}{\Delta t}$
 - $Q = \frac{1}{R} \cdot \frac{\Delta\phi}{\Delta t}$

[CLICK HERE TO SEE ANSWERS](#)



5. Magnetic lines of force
(a) always intersect
(b) are always closed
(c) do not pass through vacuum
(d) tend to crowd far way from the poles of a magnet
6. The power of electric circuit is
(a) VR
(b) V^2R
(c) $\frac{V^2}{R}$
(d) V^2RI
7. With the increase of temperature, width of the forbidden gap
(a) decreases
(b) increases
(c) remains same
(d) becomes zero
8. The kinetic energy of an electron, which is accelerated in the potential difference of 100V is
(a) $1.6 \times 10^{-17} \text{ J}$
(b) $1.6 \times 10^{-14} \text{ J}$
(c) $1.6 \times 10^{-10} \text{ J}$
(d) $1.6 \times 10^{-8} \text{ J}$
9. Coulombian force is
(a) central force
(b) electric force
(c) both a and b
(d) none of these
10. Alternating current can not be measured by DC ammeter, because
(a) AC changes direction
(b) DC ammeter will get damaged
(c) AC can not pass through DC ammeter
(d) average value of current for a complete cycle is zero
11. The final image in astronomical telescope is
(a) real and erect
(b) real and inverted
(c) virtual and inverted
(d) virtual and erect
12. An infinite number of capacitors with capacitances $1 \mu\text{F}$, $\frac{1}{2} \mu\text{F}$, $\frac{1}{4} \mu\text{F}$, $\frac{1}{8} \mu\text{F}$, etc. are connected in parallel combination. Their equivalent capacitance will be
(a) $8 \mu\text{F}$
(b) $6 \mu\text{F}$
(c) $4 \mu\text{F}$
(d) $2 \mu\text{F}$
13. **Assertion :** Ferro-magnetic substances become paramagnetic above Curie temperature.
Reason : Domains are destroyed at high temperature.
(a) Both Assertion and Reason are correct and Reason is the correct explanation of Assertion.
(b) Both Assertion and Reason are correct, but Reason is not the correct explanation of Assertion.
(c) Assertion is correct but Reason is incorrect.
(d) Assertion is incorrect but Reason is correct.



14. **Assertion :** The magnetic field produced by a current carrying solenoid is independent of its length and cross-sectional area.
Reason : The magnetic field inside the solenoid is uniform.
- (a) Both Assertion and Reason are correct and Reason is the correct explanation of Assertion.
(b) Both Assertion and Reason are correct, but Reason is not the correct explanation of Assertion.
(c) Assertion is correct but Reason is incorrect.
(d) Assertion is incorrect but Reason is correct.
15. **Assertion :** A narrow pulse of light is sent through a medium. The pulse will retain its shape as it travels through the medium.
Reason : A narrow pulse is made of harmonic waves with a large range of wavelengths.
- (a) Both Assertion and Reason are correct and Reason is the correct explanation of Assertion.
(b) Both Assertion and Reason are correct, but Reason is not the correct explanation of Assertion.
(c) Assertion is correct but Reason is incorrect.
(d) Assertion is incorrect but Reason is correct.
16. **Assertion :** Faraday's laws are consequences of conservation of energy.
Reason : In a purely resistive A.C. circuit, the current lags behind the e.m.f. in phase.
- (a) Both Assertion and Reason are correct and Reason is the correct explanation of Assertion.
(b) Both Assertion and Reason are correct, but Reason is not the correct explanation of Assertion.
(c) Assertion is correct but Reason is incorrect.
(d) Assertion is incorrect but Reason is correct.

SECTION-B

17. What is the importance of radial magnetic field in a moving coil galvanometer?
18. (i) What is the relation between critical angle and refractive index of a material ?
(ii) Does critical angle depend on the colour of light ?
19. A capacitor of capacitance C is being charged by connecting it across a DC source along with an ammeter. Will the ammeter show a momentary deflection during the process of charging? If so, how would you explain this momentary deflection and the resulting continuity of current in the circuit? Write the expression for the current inside the capacitor.
20. What are polaroid ? Mention its uses.
- OR**
- Radio-waves diffract pronouncedly around buildings, while light waves, which are electromagnetic waves, do not. Why?
21. Using the concept of force between two infinitely long parallel current carrying conductors define one ampere of current.



SECTION-C

22. Draw $V-I$ characteristics of a $p-n$ junction diode. Answer the following questions, giving reasons:
- Why is the current under reverse bias almost independent of the applied potential upto a critical voltage?
 - Why does the reverse current show a sudden increase at the critical voltage?
- Name any semiconductor device which operates under the reverse bias in the breakdown region.
23. Show that the capacitance of an insulated spherical conductor is directly proportional to the radius of the spherical conductor.
24. Briefly explain how Maxwell was led to predict the existence of electromagnetic waves.
25. Define ionisation energy. What is its value for hydrogen atom?
26. An empty test tube is placed slanting in the water and viewed from above. What will you observe?
27. Briefly describe proton-neutron hypothesis of nuclear composition.
- OR**
- What is nuclear fission? Explain how a chain reaction can occur in a fissionable material?
28. What happens when a forward bias is applied to a $p-n$ -junctions

SECTION-D

Case Study Based Questions.

Read the following paragraph and answer the questions that follow.

29. The electron mobility characterises how quickly an electron can move through a metal of semiconductor when pulled by an electric field. There is an analogous quality for holes, called hole mobility. A block of pure silicon at 300 K has a length of 10 cm and an area of 1.0 cm^2 . A battery of emf 2 V is connected across it. The mobility of electron is $0.14 \text{ m}^2 \text{ V}^{-1} \text{ s}^{-1}$ and their number density is $1.5 \times 10^{16} \text{ m}^{-3}$. The mobility of holes is $0.05 \text{ m}^2 \text{ V}^{-1} \text{ s}^{-1}$.
- The electron current is
 - $6.72 \times 10^{-4} \text{ A}$
 - $6.72 \times 10^{-5} \text{ A}$
 - $6.72 \times 10^{-6} \text{ A}$
 - $6.72 \times 10^{-7} \text{ A}$
 - The hole current is
 - $2.0 \times 10^{-7} \text{ A}$
 - $2.2 \times 10^{-7} \text{ A}$
 - $2.4 \times 10^{-7} \text{ A}$
 - $2.6 \times 10^{-7} \text{ A}$

Continue on next page.....

CLICK HERE TO INSTALL NODIA APP



- (iii) The number density of donor atoms which are to be added up to pure silicon semiconductor to produce an n -type semiconductor of conductivity $6.4 \Omega^{-1}\text{cm}^{-1}$ is approximately (neglect the contribution of holes to conductivity)
- (a) $3 \times 10^{22} \text{m}^{-3}$ (b) $3 \times 10^{23} \text{m}^{-3}$
 (c) $3 \times 10^{24} \text{m}^{-3}$ (d) $3 \times 10^{21} \text{m}^{-3}$
- (iv) When the given silicon semiconductor is doped with indium, the hole concentration increases to $4.5 \times 10^{23} \text{m}^{-3}$. The electron concentration in doped silicon is
- (a) $3 \times 10^9 \text{m}^{-3}$ (b) $4 \times 10^9 \text{m}^{-3}$
 (c) $5 \times 10^9 \text{m}^{-3}$ (d) $6 \times 10^9 \text{m}^{-3}$

OR

- (v) Pick out the statement which is not correct.
- (a) At a low temperature, the resistance of a semiconductor is very high.
 (b) Movement of holes is restricted to the valence band only.
 (c) Width of the depletion region increases as the forward bias voltage increases in case of a p - n junction diode.
 (d) In a forward bias condition, the diode heavily conducts.

30. Distance between two successive bright or dark fringes is called fringe width.

$$\beta = Y_{n+1} - Y_n$$

$$= \frac{(n+1)\lambda D}{d} - \frac{n\lambda D}{d} = \frac{\lambda D}{d}$$

Fringe width is independent of the order of the maxima. If whole apparatus is immersed in liquid of refractive index μ then $\beta = \frac{\lambda D}{\mu d}$ (fringe width decreases).

Angular fringe width (θ) is the angular separation between two consecutive maxima or minima

$$\theta = \frac{\beta}{D} = \frac{\lambda}{d}$$

In the arrangement shown in figure, slit S_3 and S_4 are having a variable separation Z . Point O on the screen is at the common perpendicular bisector of S_1S_2 and S_3S_4 .

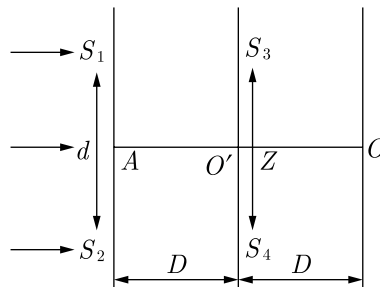

- (i) The maximum number of possible interference maxima for slit separation equal to twice the wavelength in Young's double-slit experiment, is
- (a) infinite (b) five
 (c) three (d) zero
- (ii) In Young's double slit experiment if yellow light is replaced by blue light, the interference fringes become
- (a) wider (b) brighter
 (c) narrower (d) darker



- (iii) In Young's double slit experiment, if the separation between the slits is halved and the distance between the slits and the screen is doubled, then the fringe width compared to the unchanged one will be
- (a) Unchanged (b) Halved
(c) Doubled (d) Quadrupled
- (iv) When the complete Young's double slit experiment is immersed in water, the fringes
- (a) remain unaltered (b) become wider
(c) become narrower (d) disappear
- OR**
- (v) In a two slit experiment with white light, a white fringe is observed on a screen kept behind the slits. When the screen is moved away by 0.05 m, this white fringe
- (a) does not move at all (b) gets displaced from its earlier position
(c) becomes coloured (d) disappears

SECTION-E

31. Deduce Coulomb's law from Gauss law.

OR

- (i) Can two equipotential surfaces intersect each other? Give reasons.
- (ii) Two charges $-q$ and $+q$ are located at points $A(0,0,-a)$ and $B(0,0,+a)$ respectively. How much work is done in moving a test charge from point $P(7,0,0)$ to $Q(-3,0,0)$?

32. Describe Rutherford's model of atom developed on the basis of his alpha particle scattering experiment.

OR

Calculate the shortest wavelength in the Balmer series of hydrogen atom. In which region (infrared visible, ultraviolet) of hydrogen spectrum does this wavelength lie?

33. A long solenoid with closely wound turns has n turns, per unit of its length. A steady current I flows through this solenoid. Use Ampere's circuital law to obtain an expression, for the magnetic field, at a point on its axis and close to its midpoint.

OR

- (i) Explain giving reasons, the basic difference in converting a galvanometer into (a) a voltmeter and (b) an ammeter.
- (ii) Two long straight parallel conductors carrying steady currents I_1 and I_2 are separated by a distance d .

Explain briefly with the help of a suitable diagram, how the magnetic field due to one conductor acts on the other. Hence, deduce the expression for the force acting between the two conductors. Mention the nature of this force.

□□□□□□



Sample Paper 14

Class XII 2024-25

Physics

Time: 3 Hours

Max. Marks: 70

General Instructions:

1. There are 33 questions in all. All questions are compulsory.
 2. This question paper has five sections: Section A, Section B, Section C, Section D and Section E.
 3. All the sections are compulsory.
 4. Section A contains sixteen questions, twelve MCQ and four assertion reasoning based of 1 mark each, Section B contains five questions of 2 marks each, Section C contains seven questions of 3 marks each, Section D contains two case study based questions of 4 marks each and Section E contains three long questions of 5 marks each.
 5. There is no overall choice. However, an internal choice has been provided in one question in Section B, one question in Section C, one question in each CBQ in Section D and all three questions in Section E. You have to attempt only one of the choices in such questions
 6. Use of calculators is not allowed.
 7. You may use the following values of physical constants where ever necessary
 - i. $c = 3 \times 10^8$ m/s
 - ii. $m_e = 9.1 \times 10^{-31}$ kg
 - iii. $e = 1.6 \times 10^{-19}$ C
 - iv. $\mu_0 = 4\pi \times 10^{-7}$ TmA⁻¹
 - v. $h = 6.63 \times 10^{-34}$ Js
 - vi. $\epsilon_0 = 8.854 \times 10^{-12}$ C²N⁻¹m⁻²
 - vii. Avogadro's number = 6.023×10^{23} per gram mole
-

SECTION-A

1. Which element is used in electric heater?
 - (a) Copper
 - (b) Platinum
 - (c) Tungsten
 - (d) Nichrome
2. S.I. unit of magnetic moment is
 - (a) JT⁻²
 - (b) Am²
 - (c) JT
 - (d) Am⁻¹
3. Which of the following ratios is constant for an isolated conductor?
 - (a) $\frac{\text{Total charge}}{\text{Potential}}$
 - (b) $\frac{\text{Charge added}}{\text{Potential difference}}$
 - (c) $\frac{(\text{Total charge})^2}{\text{Potential}}$
 - (d) none of these
4. If the kinetic energy of an electron doubles, its de-Broglie's wavelength changes by a factor
 - (a) 2
 - (b) $\sqrt{2}$
 - (c) $\frac{1}{2}$
 - (d) $\frac{1}{\sqrt{2}}$

[CLICK HERE TO SEE ANSWERS](#)



5. Which of the following rays are not electromagnetic waves ?
(a) γ -rays (b) β -rays
(c) X-rays (d) heat rays
6. The electrostatic field is
(a) conservative (b) non-conservative
(c) both (a) and (b) (d) none of these
7. In Young's double slit experiment, if one slit is covered with red filter and the other slit is covered by green filter, then their interference pattern will be
(a) red (b) green
(c) yellow (d) invisible
8. In an AC circuit containing only capacitor, the current
(a) leads the voltage by 90° (b) leads the voltage by 180°
(c) lags behind the voltage by 90° (d) remains in phase with the voltage
9. An object is placed at a distance f in the front of a convex mirror. If focal length of the mirror is f , then distance of image from pole of the mirror is
(a) f (b) $2f$
(c) $\frac{f}{2}$ (d) $\frac{f}{4}$
10. The Lenz's law gives
(a) direction of induced E.M.F. (b) magnitude of induced E.M.F.
(c) direction of induced current (d) magnitude of induced current
11. For an electron in the second orbit of Bohr's hydrogen atom, the moment of linear momentum is
(a) πh (b) $2\pi h$
(c) $\frac{h}{\pi}$ (d) $\frac{2h}{\pi}$
12. Two equal electric currents are flowing perpendicular to each other as shown in the figure. AB and CD are perpendicular to each other and symmetrically placed with respect to the currents. Where do we expect the resultant magnetic field to be zero ?

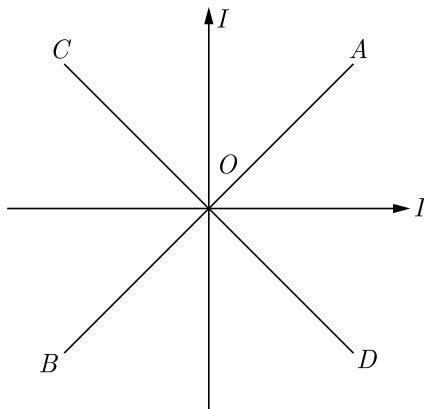

- (a) on AB (b) on CD
(c) on both AB and CD (d) on both OD and BO



13. **Assertion :** Microwaves are better carrier of signals than optical waves.
Reason : Microwaves move faster than optical waves.
(a) Both Assertion and Reason are correct and Reason is the correct explanation of Assertion.
(b) Both Assertion and Reason are correct, but Reason is not the correct explanation of Assertion.
(c) Assertion is correct but Reason is incorrect.
(d) Assertion is incorrect but Reason is correct.
14. **Assertion :** By roughening the surface of a glass sheet its transparency can be reduced.
Reason : Glass sheet with rough surface absorbs more light.
(a) Both Assertion and Reason are correct and Reason is the correct explanation of Assertion.
(b) Both Assertion and Reason are correct, but Reason is not the correct explanation of Assertion.
(c) Assertion is correct but Reason is incorrect.
(d) Assertion is incorrect but Reason is correct.
15. **Assertion :** No interference pattern is detected when two coherent sources are infinitely close to each other.
Reason : The fringe width is inversely proportional to the distance between the two slits.
(a) Both Assertion and Reason are correct and Reason is the correct explanation of Assertion.
(b) Both Assertion and Reason are correct, but Reason is not the correct explanation of Assertion.
(c) Assertion is correct but Reason is incorrect.
(d) Assertion is incorrect but Reason is correct.
16. **Assertion (A) :** The whole charge of a conductor cannot be transferred to another isolated conductor.
Reason (R) : The total transfer of charge from one to another is not possible.
(a) Both Assertion and Reason are correct and Reason is the correct explanation of Assertion.
(b) Both Assertion and Reason are correct, but Reason is not the correct explanation of Assertion.
(c) Assertion is correct but Reason is incorrect.
(d) Assertion is incorrect but Reason is correct.

SECTION-B

17. Identify the part of the electromagnetic spectrum which is
(a) suitable for radar system used in aircraft navigation.
(b) produced by bombarding a metal target by high speed electrons
18. In a certain 0.5 cm^3 of space, electric potential is found to be 7 V throughout. What is the electric field in this region ?
19. Plot a graph showing variation of photoelectric current with collector plate potential at a given frequency and intensity of incident radiation. What does the intercept of the graph with potential axis signify?

OR

What is meant by work function of a metal? How does the value of work function influence the kinetic energy of electrons liberated during photoelectron emission?

20. The relative magnetic permeability of a magnetic material is 800. Identify the nature of magnetic material and state its two properties.

[CLICK HERE TO SEE ANSWERS](#)



21. The charging current for a capacitor is 0.25 A. What is the displacement current across its plates?

SECTION-C

22. (a) Why are coherent sources necessary to produce a sustained interference pattern ?
 (b) In Young's double slit experiment using monochromatic light of wavelength λ , the intensity of light at a point on the screen where path difference is λ is K units. Find out the intensity of light at a point where path difference is $\lambda/3$.
23. Define ionization energy. How would the ionization energy change when electron in hydrogen atom is replaced by a particle of mass 200 times that of the electron but having the same charge?
24. The $V-I$ characteristic of a silicon diode is as shown in the figure. Calculate the resistance of the diode at
 1. $I = 15 \text{ mA}$
 2. $V = -10 \text{ V}$.

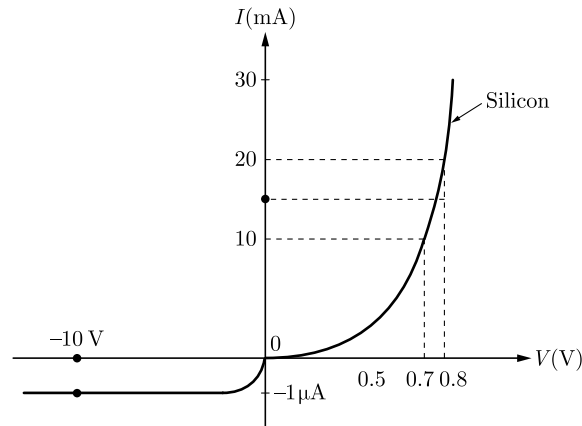

25. (a) State clearly how a microwave oven works to heat up a food item containing water molecules.
 (b) Why are microwaves found useful for the RADAR systems in aircraft navigation ?

OR

- (i) Which segment of electromagnetic waves has highest frequency ? How are these waves produced ? Give one use of these waves.
 (ii) Which electromagnetic waves lie near the high frequency one of visible part of electromagnetic spectrum ? Give its one use. In what way this component of light has harmful effects on human ?
26. Show with the help of a diagram, how the force between the two conductors would change when the currents in them flow in the opposite directions.
27. State Faraday's laws of electromagnetic induction. Express them mathematically.
28. Derive an expression for the torque experienced by electric dipole in external electric field.



SECTION-D

Case Study Based Questions.

Read the following paragraph and answer the questions that follow.

- 29.** The electron mobility characterises how quickly an electron can move through a metal of semiconductor when pulled by an electric field. There is an analogous quality for holes, called hole mobility. A block of pure silicon at 300 K has a length of 10 cm and an area of 1.0 cm^2 . A battery of emf 2 V is connected across it. The mobility of electron is $0.14 \text{ m}^2\text{V}^{-1}\text{s}^{-1}$ and their number density is $1.5 \times 10^{16} \text{ m}^{-3}$. The mobility of holes is $0.05 \text{ m}^2\text{V}^{-1}\text{s}^{-1}$.

- (i) The electron current is
 (a) $6.72 \times 10^{-4} \text{ A}$ (b) $6.72 \times 10^{-5} \text{ A}$
 (c) $6.72 \times 10^{-6} \text{ A}$ (d) $6.72 \times 10^{-7} \text{ A}$
- (ii) The hole current is
 (a) $2.0 \times 10^{-7} \text{ A}$ (b) $2.2 \times 10^{-7} \text{ A}$
 (c) $2.4 \times 10^{-7} \text{ A}$ (d) $2.6 \times 10^{-7} \text{ A}$
- (iii) The number density of donor atoms which are to be added up to pure silicon semiconductor to produce an *n*-type semiconductor of conductivity $6.4 \Omega^{-1}\text{cm}^{-1}$ is approximately (neglect the contribution of holes to conductivity)
 (a) $3 \times 10^{22} \text{ m}^{-3}$ (b) $3 \times 10^{23} \text{ m}^{-3}$
 (c) $3 \times 10^{24} \text{ m}^{-3}$ (d) $3 \times 10^{21} \text{ m}^{-3}$
- (iv) When the given silicon semiconductor is doped with indium, the hole concentration increases to $4.5 \times 10^{23} \text{ m}^{-3}$. The electron concentration in doped silicon is
 (a) $3 \times 10^9 \text{ m}^{-3}$ (b) $4 \times 10^9 \text{ m}^{-3}$
 (c) $5 \times 10^9 \text{ m}^{-3}$ (d) $6 \times 10^9 \text{ m}^{-3}$

OR

- (v) Pick out the statement which is not correct.
 (a) At a low temperature, the resistance of a semiconductor is very high.
 (b) Movement of holes is restricted to the valence band only.
 (c) Width of the depletion region increases as the forward bias voltage increases in case of a *p-n* junction diode.
 (d) In a forward bias condition, the diode heavily conducts.
- 30.** A prism is a portion of a transparent medium bounded by two plane faces inclined to each other at a suitable angle. A ray of light suffers two refractions on passing through a prism and hence deviates through a certain angle from its original path. The angle of deviation of a prism is, $\delta = (\mu - 1)A$, through which a ray deviates on passing through a thin prism of small refracting angle *A*. If μ is refractive index of the material of the prism, then prism formula is, $\mu = \frac{\sin(A + \delta_m)/2}{\sin A/2}$
- (i) For which colour, angle of deviation is minimum?
 (a) Red (b) Yellow
 (c) Violet (d) Blue
- (ii) When white light moves through vacuum
 (a) all colours have same speed (b) different colours have different speeds
 (c) violet has more speed than red (d) red has more speed than violet.

CLICK HERE TO SEE ANSWERS



- (iii) The deviation through a prism is maximum when angle of incidence is
 (a) 45° (b) 70°
 (c) 90° (d) 60°
- (iv) What is the deviation produced by a prism of angle 6° ? (Refractive index of the material of the prism is 1.644).
 (a) 3.864° (b) 4.595°
 (c) 7.259° (d) 1.252°
- (v) A ray of light falling at an angle of 50° is refracted through a prism and suffers minimum deviation. If the angle of prism is 60° , then the angle of minimum deviation is
 (a) 45° (b) 75°
 (c) 50° (d) 40°

SECTION-E

31. State the working of AC generator with the help of a labelled diagram. The coil of an AC generator having N turns, each of area A , is rotated with a constant angular velocity ω . Deduce the expression for the alternating emf generated in the coil. What is the source of energy generation in this device?

OR

Draw a labelled diagram of a step-down transformer. State the principle of its working. Express the turn ratio in terms of voltages.

Find the ratio of primary and secondary currents in terms of turn ratio in an ideal transformer.

How much current is drawn by the primary of a transformer connected to 220 V supply when it delivers power to a 100 V - 500 W refrigerator?

32. For a nuclear reaction $A + b \rightarrow c + d$, the Q -value is defined as $Q[m_A - m_b - m_d]c^2$. A radioactive nuclear ${}_{6}^{11}\text{C} \rightarrow {}_{5}^{11}\text{B} + e^+ + \nu$; $T_{1/2} = 20.3$ minutes. The maximum energy emitted by positron is 0.960 MeV. following values are given-
 $m({}_{6}^{11}\text{C}) = 11.011434u$, $m({}_{5}^{11}\text{B}) = 11.009305u$, $m_e = 0.000548u$. Evaluate Q -value of this reaction and compare it with maximum Energy Emitted by Positron.

OR

- (i) Write three characteristic properties of nuclear force.
 (ii) Draw a plot of potential energy of a pair of nucleons as a function of their separation. Write two important conclusions that can be drawn from the graph.

33. 1. Obtain the formula for the power loss (i.e. power dissipated) in a conductor of resistance R carrying a current.
 2. Two heating elements of resistances R_1 and R_2 when operated at a constant supply of voltage V , consume powers P_1 and P_2 , respectively. Deduce the expressions for the power of their combination when they are in turn, connected in
 (a) Series and
 (b) Parallel across their same voltage supply.

OR

Use Kirchoff's laws to determine the value of current I_1 in the given electrical circuit.

□□□□□□

CLICK HERE TO INSTALL NODIA APP



Sample Paper 15

Class XII 2024-25

Physics

Time: 3 Hours

Max. Marks: 70

General Instructions:

1. There are 33 questions in all. All questions are compulsory.
2. This question paper has five sections: Section A, Section B, Section C, Section D and Section E.
3. All the sections are compulsory.
4. Section A contains sixteen questions, twelve MCQ and four assertion reasoning based of 1 mark each, Section B contains five questions of 2 marks each, Section C contains seven questions of 3 marks each, Section D contains two case study based questions of 4 marks each and Section E contains three long questions of 5 marks each.
5. There is no overall choice. However, an internal choice has been provided in one question in Section B, one question in Section C, one question in each CBQ in Section D and all three questions in Section E. You have to attempt only one of the choices in such questions
6. Use of calculators is not allowed.
7. You may use the following values of physical constants where ever necessary
 - i. $c = 3 \times 10^8$ m/s
 - ii. $m_e = 9.1 \times 10^{-31}$ kg
 - iii. $e = 1.6 \times 10^{-19}$ C
 - iv. $\mu_0 = 4\pi \times 10^{-7}$ TmA⁻¹
 - v. $h = 6.63 \times 10^{-34}$ Js
 - vi. $\epsilon_0 = 8.854 \times 10^{-12}$ C²N⁻¹m⁻²
 - vii. Avogadro's number = 6.023×10^{23} per gram mole

SECTION-A

1. A wire of magnetic dipole moment M and L is bent into shape of a semicircle of radius r . What will be its new dipole moments?
 - (a) M
 - (b) $\frac{M}{2\pi}$
 - (c) $\frac{M}{\pi}$
 - (d) $\frac{2M}{\pi}$
2. A charged ball B hangs from a silk thread S , which makes an angle θ with a large charged conducting sheet P , as shown in the figure. The surface charge density σ of the sheet is proportional to

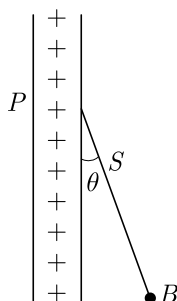

- (a) $\sin \theta$
- (b) $\cos \theta$
- (c) $\tan \theta$
- (d) $\cot \theta$

[CLICK HERE TO SEE ANSWERS](#)



3. Magnetic field due to a long straight conductor of length l , carrying current I , at a point, distance d from it, is given by

(a) $B = \frac{\mu_0}{4\pi} \times \frac{2I}{d}$

(b) $B = \frac{\mu_0}{4\pi} \times \frac{I}{d}$

(c) $B = \frac{\mu_0}{4\pi} \times \frac{2I}{d^2}$

(d) $B = \frac{\mu_0}{\pi} \times \frac{2I}{d}$

4. A rectangular coil $ABCD$ is rotated anticlockwise with a uniform angular velocity about the axis shown in the figure. Initially, the axis of rotation of the coil as well as the magnetic field B were horizontal. The induced E.M.F. in the coil would be maximum when plane of the coil

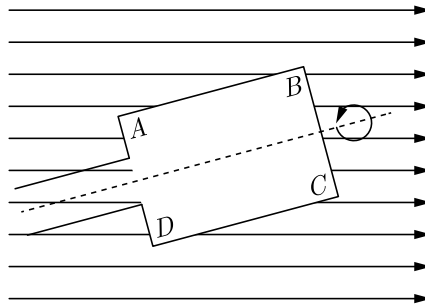

- (a) is horizontal.
 (b) is at right angle to the magnetic field.
 (c) makes an angle of 30° with the horizontal.
 (d) makes an angle of 45° with the direction of magnetic field.
5. The variation of voltage V and current I in a conductor is given below. The resistance of the conductor is

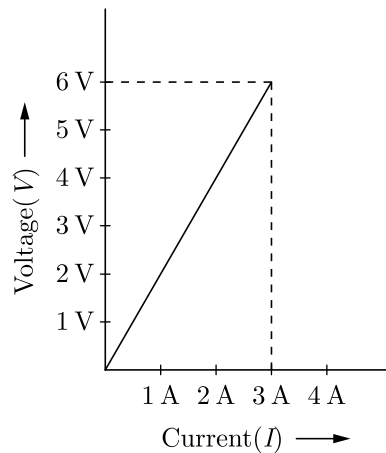

- (a) 1Ω
 (b) 2Ω
 (c) 3Ω
 (d) 4Ω
6. The unit of ratio of magnetic field, B and electrical field, $E(B/E)$ is
- (a) ms^{-1}
 (b) sm^{-1}
 (c) ms
 (d) m^{-2}



7. A current passing through a circular coil of two turns produces a magnetic field of 8 T at its centre. The coil is then rewound, so as to have four turns and current is passed through it is doubled. Now magnetic field at the centre of the coil will be
- (a) 64 T (b) 32 T
(c) 16 T (d) 8 T
8. A diffraction pattern is obtained by using a beam of red light. What happens, if the red light is replaced by blue light?
- (a) no change
(b) diffraction bands disappear
(c) diffraction bands become broader and farther apart
(d) diffraction bands become narrower and crowded together
9. The energy E of a hydrogen atom with principal quantum no. n is given by $E = -\frac{13.6}{n^2}$ eV. The energy ejected when the electron jumps from $n = 3$ state to $n = 2$ state of hydrogen is approximately
- (a) 0.85 eV (b) 1.5 eV
(c) 1.9 eV (d) 3.4 eV
10. If 125 water drops of equal radius and equal capacitance C , coalesce to form a single drop of capacitance C' the relation between C and C' is
- (a) $C' = C$ (b) $C' = 5C$
(c) $C' = 125C$ (d) $C' = 250C$
11. The magnetic flux through a circuit of resistance R changes by an amount $\Delta\phi$ in a time Δt . The total electric charge Q that passes any point in the circuit during the time Δt is represented by
- (a) $Q = \frac{\Delta\phi}{\Delta t}$ (b) $Q = \frac{\Delta\phi}{R}$
(c) $Q = R \cdot \frac{\Delta\phi}{\Delta t}$ (d) $Q = \frac{1}{R} \cdot \frac{\Delta\phi}{\Delta t}$
12. A parallel plate capacitor is made by stacking n equally spaced plates connected alternatively. If capacitance between any two adjacent plates is C , then the resultant capacitance is
- (a) C (b) nC
(c) $(n - 1)C$ (d) $(n + 1)C$
13. **Assertion :** The resistivity of a semi-conductor increases with temperature.
Reason : The atoms of semi-conductor vibrate with larger amplitude as higher temperatures thereby increasing its resistivity.
- (a) Both Assertion and Reason are correct and the Reason is a correct explanation of the Assertion.
(b) Both Assertion and Reason are correct but Reason is not a correct explanation of the Assertion.
(c) The Assertion is correct but Reason is incorrect.
(d) Both the Assertion and Reason are incorrect.



14. **Assertion :** Kinetic energy of photo electrons emitted by a photosensitive surface depends upon the intensity of incident photon.
Reason : The ejection of electrons from metallic surface is possible with frequency of incident photon below the threshold frequency.
- (a) Both Assertion and Reason are correct and the Reason is a correct explanation of the Assertion.
 - (b) Both Assertion and Reason are correct but Reason is not a correct explanation of the Assertion.
 - (c) The Assertion is correct but Reason is incorrect.
 - (d) Both the Assertion and Reason are incorrect.
15. **Assertion :** When tiny circular obstacle is placed in the path of light from some distance, a bright spot is seen at the centre of the shadow of the obstacle.
Reason : Destructive interference occurs at the centre of the shadow.
- (a) Both Assertion and Reason are correct and the Reason is a correct explanation of the Assertion.
 - (b) Both Assertion and Reason are correct but Reason is not a correct explanation of the Assertion.
 - (c) The Assertion is correct but Reason is incorrect.
 - (d) Both the Assertion and Reason are incorrect.
16. **Assertion :** The depletion layer in the $p-n$ junction is free from mobile charge carriers.
Reason : There is no electric field across the junction barrier.
- (a) Both Assertion and Reason are correct and the Reason is a correct explanation of the Assertion.
 - (b) Both Assertion and Reason are correct but Reason is not a correct explanation of the Assertion.
 - (c) The Assertion is correct but Reason is incorrect.
 - (d) Both the Assertion and Reason are incorrect.

SECTION-B

17. The radii of curvature of both the surfaces of a lens are equal. If one of the surfaces is made plane by grinding then will the focal length of lens change? Will the power change?
18. Alloys of metals have greater resistivity than their constituent metals. Why?
19. Write any two properties of X -rays.
20. What happens when a forward bias is applied to a $p-n$ -junctions

OR

Draw energy band diagram of n -typed and p -typed semiconductor at temperature $T > 0\text{ K}$. Mark the donor and acceptor energy level with their energies.

21. Explain briefly how electromagnetic waves are produced by an oscillating charge. How is the frequency of electromagnetic waves produced related to that of the oscillating charge?

[CLICK HERE TO INSTALL NODIA APP](#)



SECTION-C

22. Compare the electric fields due to a monopole (single charge) and dipole.
23. The ground state energy of hydrogen atom is -13.6 eV . If an electron makes a transition from an energy level -0.85 eV to -3.4 eV , calculate the wavelength of the spectral line emitted. To which series of hydrogen spectrum does this wavelength belong?
24. Define magnetic field in terms of the force on a moving charge. Hence define one tesla.
25. Define resolving power of an optical instrument. How does it depend on wavelength?
26. Write down the equation of induced current at any instant in L-C-R circuit when $X_L > X_C$ or circuit is inductive.
27. Explain briefly the reasons why wave theory of light is not able to explain the observed features of photoelectric effect.

OR

The following graph shows the variation of stopping potential V_s with the frequency (ν) of the incident radiation for two photosensitive metals X and Y .

- (i) Which of the metals has larger threshold wavelength? Give reason.
- (ii) Explain giving reason which metal gives out electrons having larger kinetic energy, for the same wavelength of the incident radiation.
- (iii) If the distance between the light source and metal X is halved, what will be the kinetic energy of electrons emitted due to this change? Give reason.

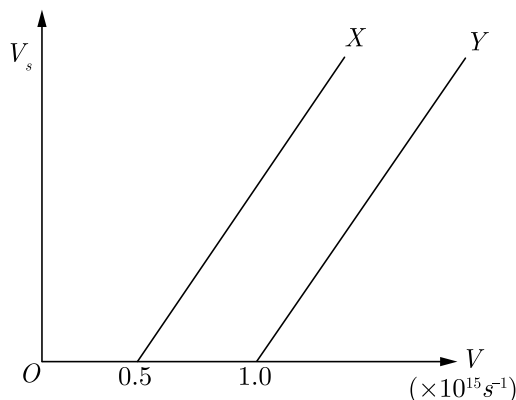

28. There are two coils A and B separated by some distance. If a current of 2 A flows through A , a magnetic flux of 10^{-2} Wb passes through B (no current through B). If no current passes through A and a current of 1 A passes through B , What is the flux through A ?

[CLICK HERE TO SEE ANSWERS](#)



SECTION-D

Case Study Based Questions.

Read the following paragraph and answer the questions that follow.

- 29.** Solar cell is a p - n junction diode which converts solar energy into electric energy. It is basically a solar energy converter. The upper layer of solar cell is of p -type semiconductor and very thin so that the incident light photons may easily reach the p - n junction. On the top face of p -layer, the metal finger electrodes are prepared in order to have enough spacing between the fingers for the lights to reach the p - n junction through p -layer.

- (i) The schematic symbol of solar cell is

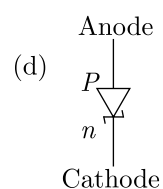
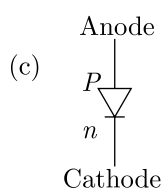
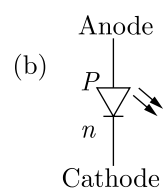
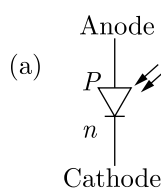

- (ii) The p - n junction which generates an emf when solar radiations fall on it, with no external bias applied, is a
- | | |
|--------------------------|-------------------|
| (a) light emitting diode | (b) photo-diode |
| (c) solar cell | (d) None of these |
- (iii) For satellites the source of energy is
- | | |
|-----------------|-------------------|
| (a) Solar cell | (b) Fuel cell |
| (c) Edison cell | (d) None of these |
- (iv) Which of the following material is used in solar cell?
- | | |
|------------|--------------|
| (a) Barium | (b) Silicon |
| (c) Silver | (d) Selenium |

OR

The efficiency of a solar cell may be in the range

- | | |
|---------------|---------------|
| (a) 2 to 5% | (b) 10 to 15% |
| (c) 30 to 40% | (d) 70 to 80% |



30. Power (P) of a lens is given by reciprocal of focal length (f) of the lens *i.e.*, $P = \frac{1}{f}$, where f is in metre and P is in dioptre. For a convex lens, power is positive and for a concave lens, power is negative. When a number of thin lenses of powers P_1, P_2, P_3, \dots are held in contact with one another, the power of the combination is given by algebraic sum of the powers of all the lenses *i.e.*, $P = P_1 + P_2 + P_3 + \dots$
- (i) A convex and a concave lens separated by distance d are then put in contact. The focal length of the combination
- (a) becomes (b) remains the same
(c) decreases (d) increases
- (ii) If two lenses of power +1.5 D and +1.0 D are placed in contact, then the effective power of combination will be
- (a) 2.5 D (b) 1.5 D
(c) 0.5 D (d) 3.25 D
- (iii) If the power of a lens is +5 dioptre, what is the focal length of the lens ?
- (a) 10 cm (b) 20 cm
(c) 15 cm (d) 5 cm
- (iv) Two thin lenses of focal lengths +10 cm and -5 cm are kept in contact. The power of the combination is
- (a) -10 D (b) -20 D
(c) 10 D (d) 15 D

OR

A convex lens of focal length 25 cm is placed coaxially in contact with a concave lens of focal length 20 cm. The system will be

- (a) converging in nature (b) diverging in nature
(c) can be converging or diverging (d) None of the above

SECTION-E

31. In a metre bridge experiment, null point is contained at 20 cm from one end of the wire when resistance X is balanced against another resistance Y . If $X < Y$, then where will be the new position of the null point from the same end, if one decides to balance a resistance of $4X$ against Y ?

OR

- (i) Define the term drift velocity.
- (ii) On the basis of electron drift, derive an expression for resistivity of a conductor in terms of number density of free electrons and relaxation time. On what factors does resistivity of a conductor depend?
- (iii) Why alloys like constantan and manganin are used for making standard resistors?



32. Find an expression for capacity of a parallel plate capacitor with compound dielectric.

OR

Derive an expression for the capacitance of a parallel plate capacitor. If a compound dielectric medium is introduced between the plates of the capacitor, how will the capacitance of the capacitor change?

33. How are wavefront and secondary wavelets defined? Verify laws of reflection or laws of refraction on the basis of Huygen's wave theory.

OR

Explain Huygens principle of secondary wavelets and on the basis of this principle establish the law of Refraction 'OR' reflection.

□□□□□□



Sample Paper 16

Class XII 2024-25

Physics

Time: 3 Hours

Max. Marks: 70

General Instructions:

1. There are 33 questions in all. All questions are compulsory.
2. This question paper has five sections: Section A, Section B, Section C, Section D and Section E.
3. All the sections are compulsory.
4. Section A contains sixteen questions, twelve MCQ and four assertion reasoning based of 1 mark each, Section B contains five questions of 2 marks each, Section C contains seven questions of 3 marks each, Section D contains two case study based questions of 4 marks each and Section E contains three long questions of 5 marks each.
5. There is no overall choice. However, an internal choice has been provided in one question in Section B, one question in Section C, one question in each CBQ in Section D and all three questions in Section E. You have to attempt only one of the choices in such questions
6. Use of calculators is not allowed.
7. You may use the following values of physical constants where ever necessary
 - i. $c = 3 \times 10^8$ m/s
 - ii. $m_e = 9.1 \times 10^{-31}$ kg
 - iii. $e = 1.6 \times 10^{-19}$ C
 - iv. $\mu_0 = 4\pi \times 10^{-7}$ TmA⁻¹
 - v. $h = 6.63 \times 10^{-34}$ Js
 - vi. $\epsilon_0 = 8.854 \times 10^{-12}$ C²N⁻¹m⁻²
 - vii. Avogadro's number = 6.023×10^{23} per gram mole

SECTION-A

1. If a circuit consists of inductance L , capacitance C and resistance R , then the resonant frequency of an LCR-circuit is
 - (a) $\pi\sqrt{LC}$
 - (b) $2\pi\sqrt{LC}$
 - (c) $2\pi\sqrt{\frac{1}{LC}}$
 - (d) $\frac{1}{2\pi\sqrt{LC}}$
2. When a charged particle moves perpendicular to a magnetic field, then
 - (a) Speed of the particle is changed
 - (b) Speed of the particle remains unchanged
 - (c) Direction of the particle remains unchanged
 - (d) Acceleration of the particle remains unchanged
3. A parallel plate capacitor with oil between the plates (dielectric constant of oil $K = 2$) has a capacitance C . If the oil is removed, then capacitance of the capacitor becomes
 - (a) $\sqrt{2}C$
 - (b) $2C$
 - (c) $\frac{C}{\sqrt{2}}$
 - (d) $\frac{C}{2}$

Continue on next page.....

CLICK HERE TO SEE ANSWERS



4. If red and violet light rays are of focal lengths f_R and f_V , then which of the following is true relationship?
(a) $\lambda_R < \lambda_V$ (b) $\alpha_R < \alpha_V$
(c) $\alpha_R > \alpha_V$ (d) $\lambda_R \leq \lambda_V$
5. Huygen's wave theory of light can not explain
(a) Diffraction (b) Interference
(c) Polarisation (d) Photoelectric effect
6. Which series comes in visible region of hydrogen spectrum?
(a) Lyman series (b) Balmer series
(c) Paschen series (d) Bracket series
7. The mutual inductance, when the magnetic flux changes by 5×10^{-2} Wb and current change by 0.01 A, is
(a) 0.2 H (b) 2.5 H
(c) 5 H (d) 10 H
8. The electric field at a point near an infinite thin sheet of charged conductor is
(a) $\varepsilon_0 \sigma$ (b) $\frac{\sigma}{\varepsilon_0}$
(c) $\frac{\sigma}{2\varepsilon_0}$ (d) $\frac{1}{2}\sigma\varepsilon_0$
9. Which radiation in sunlight, causes heating effect?
(a) Ultra violet (b) Infra-red
(c) Visible light (d) All of these
10. Which of the following is an example for diamagnetic substances?
(a) Copper (b) Nickel
(c) Aluminum (d) Iron
11. A 100 W, 200 V bulb is connected to a 160 volts supply. The actual power consumption would be
(a) 64 W (b) 80 W
(c) 100 W (d) 125 W
12. Which one of following is charge less?
(a) Alpha particle (b) Beta particle
(c) Photon particle (d) Proton
13. **Assertion :** Thin films such a soap bubble or a thin layer of oil on water show beautiful colours when illuminated by white light.
Reason : It happens due to the interference of light reflected from the upper surface of the thin film.
(a) Both Assertion and Reason are correct and Reason is the correct explanation of Assertion.
(b) Both Assertion and Reason are correct, but Reason is not the correct explanation of Assertion.
(c) Assertion is correct but Reason is incorrect.
(d) Assertion is incorrect but Reason is correct.



14. **Assertion :** Diamond glitters brilliantly.
Reason : Diamond does not absorb sunlight.
- (a) Both Assertion and Reason are correct and Reason is the correct explanation of Assertion.
(b) Both Assertion and Reason are correct, but Reason is not the correct explanation of Assertion.
(c) Assertion is correct but Reason is incorrect.
(d) Assertion is incorrect but Reason is correct.
15. **Assertion :** The true geographic north direction is found by using a compass needle.
Reason : The magnetic meridian of the earth is along the axis of rotation of the earth.
- (a) Both Assertion and Reason are correct and Reason is the correct explanation of Assertion.
(b) Both Assertion and Reason are correct, but Reason is not the correct explanation of Assertion.
(c) Assertion is correct but Reason is incorrect.
(d) Assertion is incorrect but Reason is correct.
16. **Assertion (A) :** If the distance between parallel plates of a capacitor is halved and dielectric constant is made three times, then the capacitance becomes six times.
Reason (R) : Capacitance of the capacitor does not depend upon the nature of the material of the plates.
- (a) Both Assertion and Reason are correct and Reason is the correct explanation of Assertion.
(b) Both Assertion and Reason are correct, but Reason is not the correct explanation of Assertion.
(c) Assertion is correct but Reason is incorrect.
(d) Assertion is incorrect but Reason is correct.

SECTION-B

17. Define Capacitor reactance. Write its SI units.
18. Define potential gradient. Give its units.
19. Why is ferromagnetism not found in liquids and gases?
20. How does focal length of a lens change when red light incident on it is replaced by violet light? Give reason for your answer.

OR

Explain the brilliance of a diamond.

Continue on next page.....

[CLICK HERE TO SEE ANSWERS](#)



21. Define the dielectric constant of a medium. What is its unit?

SECTION-C

22. State the law of conservation of charge. Give two examples to illustrate it.
23. Write an expression for the maximum kinetic energy acquired by charged particles accelerated by a cyclotron.
24. A ray PQ incident on the refracting face BA is refracted in the prism BAC as shown in the figure and emerges from the other refracting face AC as RS such that $AQ = AR$. If angle of prism $A = 60^\circ$ and refractive index of material of prism is $\sqrt{3}$, calculate angle θ .

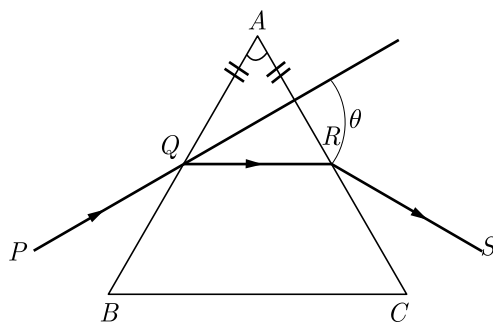

25. What is the ratio of radii of the orbits corresponding to first excited state and ground state, in a hydrogen atom?
26. (i) What characteristic property of nuclear force explains the constancy of binding energy per nucleon (BE/A) in the range of mass number. 'A'....lying $30 < A < 170$?
- (ii) Show that the density of nucleus over a wide range of nuclei is constant independent of mass number A.
27. Define resolving power of a telescope. On what factors does it depend?

OR

Show that maximum intensity in interference pattern is four times the intensity due to each slit. Hence show that interference involves only redistribution of energy.

28. Distinguish between 'Intrinsic' and 'extrinsic' semiconductors?

Continue on next page.....

CLICK HERE TO INSTALL NODIA APP



SECTION-D

Case Study Based Questions.

Read the following paragraph and answer the questions that follow.

29. **Motion of Charged Particle in Uniform Electric Field.** When a charged particle is placed in an electric field, it experiences an electrical force. If this is the only force on the particle, it must be the net force. The net force will cause the particle to accelerate according to Newton's second law. So

$$\vec{F}_e = q\vec{E} = m\vec{a}$$

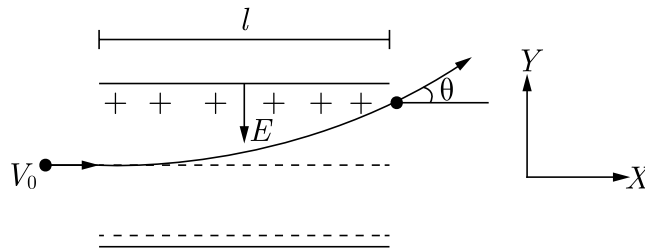

If \vec{E} is uniform, then \vec{a} is constant and $\vec{a} = q\vec{E}/m$. If the particle has a positive charge, its acceleration is in the direction of the field. If the particle has a negative charge, its acceleration is in the direction opposite to the electric field. Since the acceleration is constant, the kinematic equations can be used.

- (i) An electron of mass m , charge e falls through a distance h metre in a uniform electric field E . Then time of fall,
- (a) $t = \sqrt{\frac{2hm}{eE}}$
- (b) $t = \frac{2hm}{eE}$
- (c) $t = \sqrt{\frac{2eE}{hm}}$
- (d) $t = \frac{2eE}{hm}$
- (ii) An electron moving with a constant velocity v along X-axis enters a uniform electric field applied along Y-axis. Then the electron moves
- (a) with uniform acceleration along Y-axis
- (b) without any acceleration along Y-axis
- (c) in a trajectory represented as $y = ax^2$
- (d) in a trajectory represented as $y = ax$
- (iii) Two equal and opposite charges of masses m_1 and m_2 are accelerated in an uniform electric field through the same distance. What is the ratio of their accelerations if their ratio of masses is $\frac{m_1}{m_2} = 0.5$?

CLICK HERE TO SEE ANSWERS



- (a) $\frac{a_1}{a_2} = 2$
 (b) $\frac{a_1}{a_2} = 0.5$
 (c) $\frac{a_1}{a_2} = 3$
 (d) $\frac{a_1}{a_2} = 1$

(iv) A particle of mass m carrying charge q is kept at rest in a uniform electric field E and then released. The kinetic energy gained by the particle, when it moves through a distance y is

- (a) $\frac{1}{2} qEy^2$
 (b) qEy
 (c) qEy^2
 (d) qE^2y

OR

A charged particle is free to move in an electric field. It will travel

- (a) always along a line of force
 (b) along a line of force, if its initial velocity is zero
 (c) along a line of force, if it has some initial velocity in the direction of an acute angle with the line of force
 (d) none of these.

30. Huygen's principle is the basis of wave theory of light. Each point on a wavefront acts as a fresh source of new disturbance, called secondary waves or wavelets. The secondary wavelets spread out in all directions with the speed light in the given medium. An initially parallel cylindrical beam travels in a medium of refractive index $\propto(I) = \alpha_0 + \alpha_2 I$, where μ_0 and μ_2 are positive constants and I is the intensity of the light beam. The intensity of the beam is decreasing with increasing radius.

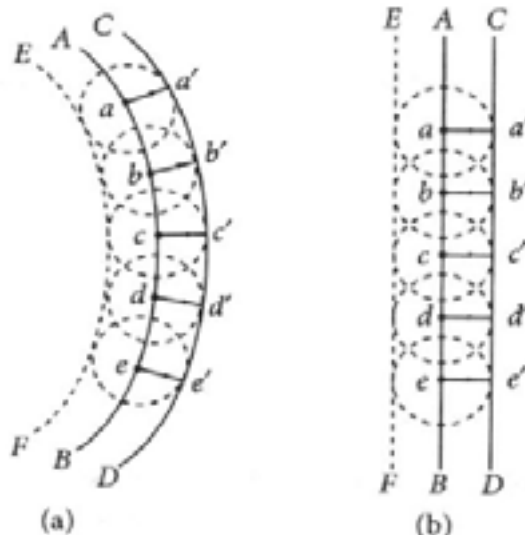

- (i) The initial shape of the wavefront of the beam is
- (a) planar
 - (b) convex
 - (c) concave
 - (d) convex near the axis and concave near the periphery
- (ii) According to Huygens Principle, the surface of constant phase is
- (a) called an optical ray
 - (b) called a wave
 - (c) called a wavefront
 - (d) always linear in shape
- (iii) As the beam enters the medium, it will
- (a) travel as a cylindrical beam
 - (b) diverge
 - (c) converge
 - (d) diverge near the axis and converge near the periphery.
- (iv) Two plane wavefronts of light, one incident on a thin convex lens and another on the refracting face of a thin prism. After refraction at them, the emerging wavefronts respectively become
- (a) plane wavefront and plane wavefront
 - (b) plane wavefront and spherical wavefront
 - (c) spherical wavefront and plane wavefront
 - (d) spherical wavefront and spherical wavefront

OR

Which of the following phenomena support the wave theory of light?

1. Scattering
 2. Interference
 3. Diffraction
 4. Velocity of light in a denser medium is less than the velocity of light in the rarer medium
- (a) 1, 2, 3
 - (b) 1, 2, 4
 - (c) 2, 3, 4
 - (d) 1, 3, 4

Continue on next page.....

CLICK HERE TO SEE ANSWERS



SECTION-E

31. What are energy bands in solids ? How are semiconductors, insulators and conductors classified on the basis of band theory?

OR

Using Kirchhoff's rule in the given circuit, determine (i) the voltage drop across the unknown resistor R and (ii) the current I in the arm EF .

32. Describe the various experiments performed by Faraday and Henry which ultimately led to the discovery of the phenomenon of electromagnetic induction.

OR

A rectangular coil of 300 turns has an area of 25 cm. The coil rotates with a speed of 50 c.p.s. in a uniform magnetic field of 4×10^{-2} T, about an axis perpendicular to the field. What is the value of peak induced E.M.F. in it?

33. What is an electromagnetic wave? How can we express mathematically a plane electromagnetic wave propagating along X-axis? Also represent it graphically.

OR

What is electromagnetic spectrum? Draw a sketch of electromagnetic spectrum indicating the frequency and wavelength ranges of its different parts.

□□□□□□



Sample Paper 17

Class XII 2024-25

Physics

Time: 3 Hours

Max. Marks: 70

General Instructions:

1. There are 33 questions in all. All questions are compulsory.
 2. This question paper has five sections: Section A, Section B, Section C, Section D and Section E.
 3. All the sections are compulsory.
 4. Section A contains sixteen questions, twelve MCQ and four assertion reasoning based of 1 mark each, Section B contains five questions of 2 marks each, Section C contains seven questions of 3 marks each, Section D contains two case study based questions of 4 marks each and Section E contains three long questions of 5 marks each.
 5. There is no overall choice. However, an internal choice has been provided in one question in Section B, one question in Section C, one question in each CBQ in Section D and all three questions in Section E. You have to attempt only one of the choices in such questions
 6. Use of calculators is not allowed.
 7. You may use the following values of physical constants where ever necessary
 - i. $c = 3 \times 10^8$ m/s
 - ii. $m_e = 9.1 \times 10^{-31}$ kg
 - iii. $e = 1.6 \times 10^{-19}$ C
 - iv. $\mu_0 = 4\pi \times 10^{-7}$ TmA⁻¹
 - v. $h = 6.63 \times 10^{-34}$ Js
 - vi. $\epsilon_0 = 8.854 \times 10^{-12}$ C²N⁻¹m⁻²
 - vii. Avogadro's number = 6.023×10^{23} per gram mole
-

SECTION-A

1. Which nature of the wave-front is associated with a parallel beam of light?
 - (a) Plane
 - (b) Spherical
 - (c) Cylindrical
 - (d) All of these
2. A sheet of aluminium foil of negligible thickness is introduced between the plates of a capacitor. The capacitance of the capacitor
 - (a) Increases
 - (b) Decreases
 - (c) Becomes infinite
 - (d) Remains unchanged
3. In a series LCR-circuit, resistance $R = 10 \Omega$ and the impedance $Z = 20 \Omega$. The phase difference between the current and the voltage is
 - (a) 30°
 - (b) 45°
 - (c) 60°
 - (d) 90°
4. Which series of hydrogen spectrum does not lie in infrared region?
 - (a) Humphreys series
 - (b) Pfund series
 - (c) Bracket series
 - (d) Lyman series

[CLICK HERE TO SEE ANSWERS](#)



5. A point object is placed at the centre of a glass sphere of radius 6 cm and refractive index 1.5. The distance of the virtual image from the surface of the sphere is
- (a) 2 cm (b) 4 cm
(c) 6 cm (d) 12 cm
6. A toroid has a core of inner radius 20 cm and outer radius 22 cm around which 4200 turns of a wire are wound. If current in the wire is 10 A, then magnetic field inside the core of toroid is
- (a) 0.01 T (b) 0.02 T
(c) 0.04 T (d) 0.08 T
7. Which of the following is/are not electromagnetic waves?
- (a) β -rays (b) X-rays
(c) cosmic rays (d) both a and b
8. The current flowing through a lamp, marked as 60 W and 240 V is
- (a) 0.25 A (b) 1 A
(c) 2.5 A (d) 5 A
9. The mutual inductance of two coils can be increased by
- (a) increasing the length of coils (b) increasing the no. of turns in the coils
(c) winding the coils on wooden cores (d) decreasing the no. of turns in the coils
10. If a material, placed in a magnetic field is thrown out of it, then the material is
- (a) Diamagnetic (b) Paramagnetic
(c) Ferromagnetic (d) Non-magnetic
11. The energy of emitted photo electron depends upon
- (a) Intensity of light (b) Wavelength of light
(c) Work-function of metal (d) None of these
12. The S.I. unit of electric field \vec{E} is
- (a) Cm^{-2} (b) NC^{-1}
(c) Am (d) Vm^{-1}
13. **Assertion :** In a movie, ordinarily 24 frames are projected per second from one end to the other of the complete film.
Reason : The image formed on retina of eye is sustained upto 1/10 second after the removal of stimulus.
- (a) Both Assertion and Reason are correct and Reason is the correct explanation of Assertion.
(b) Both Assertion and Reason are correct, but Reason is not the correct explanation of Assertion.
(c) Assertion is correct but Reason is incorrect.
(d) Assertion is incorrect but Reason is correct.

Continue on next page.....

CLICK HERE TO INSTALL NODIA APP

14. **Assertion :** When tiny circular obstacle is placed in the path of light from some distance, a bright spot is seen at the centre of the shadow of the obstacle.
Reason : Destructive interference occurs at the centre of the shadow.
- (a) Both Assertion and Reason are correct and Reason is the correct explanation of Assertion.
 - (b) Both Assertion and Reason are correct, but Reason is not the correct explanation of Assertion.
 - (c) Assertion is correct but Reason is incorrect.
 - (d) Assertion is incorrect but Reason is correct.
15. **Assertion :** In high latitudes one sees colourful curtains of light hanging down from high altitudes.
Reason : The high energy charged particles from the sun are deflected to polar regions by the magnetic field of the earth.
- (a) Both Assertion and Reason are correct and Reason is the correct explanation of Assertion.
 - (b) Both Assertion and Reason are correct, but Reason is not the correct explanation of Assertion.
 - (c) Assertion is correct but Reason is incorrect.
 - (d) Assertion is incorrect but Reason is correct.
16. **Assertion (A) :** Circuits containing capacitors should be handled cautiously even when there is no current.
Reason (R) : The capacitors are very delicate and so quickly breakdown.
- (a) Both Assertion and Reason are correct and Reason is the correct explanation of Assertion.
 - (b) Both Assertion and Reason are correct, but Reason is not the correct explanation of Assertion.
 - (c) Assertion is correct but Reason is incorrect.
 - (d) Assertion is incorrect but Reason is correct.

SECTION-B

17. Define uniform magnetic field. How is it represented geometrically?
18. Alloys of metals have greater resistivity than their constituent metals. Why?
19. Why is the use of AC voltage preferred over DC voltage? Give two reasons.
20. The refractive index of diamond is much greater than that of glass. How does a diamond cutter make use of that fact?

OR

What do you mean by refraction of light?

21. Distinguish between a dielectric and a conductor.

Continue on next page.....

[CLICK HERE TO SEE ANSWERS](#)



SECTION-C

22. Draw a ray diagram to show the image formation by a concave mirror. When the object is kept between its focus and the pole. Using this diagram. Derive the magnification formula for the image formed.
23. Find the ratio of energies of photons produced due to transition of an electron of hydrogen atom from its
(i) second permitted energy level to the first permitted level and
(ii) the highest permitted energy level to the first permitted level.
24. What happens when a forward bias is applied to a $p-n$ -junctions
25. Write an expression for the maximum kinetic energy acquired by charged particles accelerated by a cyclotron.
26. What do you mean by Nuclear Fission?
27. Two sources of intensity I_1 and I_2 undergo interference in Young's double slit experiment. Show that $\frac{I_{\max}}{I_{\min}} = \left(\frac{a_1 + a_2}{a_1 - a_2}\right)^2$, where a_1 and a_2 are the amplitudes of disturbance of two sources S_1 and S_2 .

OR

What will happen if Young's double slit experiment is performed in water?

28. Distinguish between conductors and insulators. Give examples.

SECTION-D

29. In 1909, Robert Millikan was the first to find the charge of an electron in his now-famous oil-drop experiment. In that experiment, tiny oil drops were sprayed into a uniform electric field between a horizontal pair of oppositely charged plates. The drops were observed with a magnifying eyepiece, and the electric field was adjusted so that the upward force on some negatively charged oil drops was just sufficient to balance the downward force of gravity. That is, when suspended, upward force qE just equalled Mg . Millikan accurately measured the charges on many oil drops and found the values to be whole number multiples of 1.6×10^{-19} C the charge of the electron. For this, he won the Nobel prize.

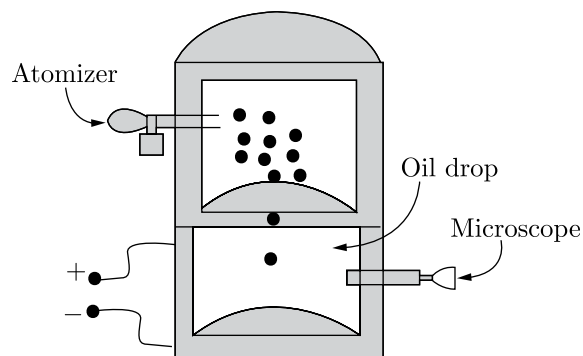

[CLICK HERE TO INSTALL NODIA APP](#)



- (i) If a drop of mass 1.08×10^{-14} kg remains stationary in an electric field of $1.68 \times 10^5 \text{ NC}^{-1}$, then the charge of this drop is
- $6.40 \times 10^{-19} \text{ C}$
 - $3.2 \times 10^{-19} \text{ C}$
 - $1.6 \times 10^{-19} \text{ C}$
 - $4.8 \times 10^{-19} \text{ C}$
- (ii) Extra electrons on this particular oil drop (given the presently known charge of the electron) are
- 4
 - 3
 - 5
 - 8
- (iii) A negatively charged oil drop is prevented from falling under gravity by applying a vertical electric field 100 Vm^{-1} . If the mass of the drop is 1.6×10^{-3} g, the number of electrons carried by the drop is ($g = 10 \text{ m s}^{-2}$)
- 10^{18}
 - 10^{15}
 - 10^{12}
 - 10^9
- (iv) The important conclusion given by Millikan's experiment about the charge is
- charge is never quantized
 - charge has no definite value
 - charge is quantized
 - charge on oil drop always increases.

OR

If in Millikan's oil drop experiment, charges on drops are found to be $8 \mu\text{C}$, $12 \mu\text{C}$, $20 \mu\text{C}$, then quanta of charge is

- $8 \mu\text{C}$
- $20 \mu\text{C}$
- $12 \mu\text{C}$
- $4 \mu\text{C}$

30. Wavefront is a locus of points which vibration in same phase. A ray of light is perpendicular to the wavefront. According to Huygens principle, each point of the wavefront is the source of a secondary disturbance and the wavelets connecting from these points spread out in all directions with the speed of wave. The figure shows a surface XY separating two transparent media, medium -1 and medium -2. The lines ab and cd represent wavefronts of a light wave travelling in medium -1 and incident on XY . The lines ef and gh represent wavefronts of the light wave in medium -2 after refraction.

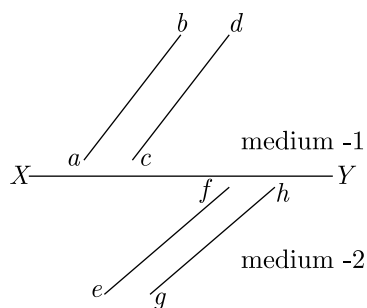

- (i) Light travels as a
- parallel beam in each medium
 - convergent beam in each medium
 - divergent beam in each medium
 - divergent beam in one medium and convergent beam in the other medium.

CLICK HERE TO SEE ANSWERS



- (ii) The phases of the light wave at c , d , e and f are ϕ_c , ϕ_d , ϕ_e and ϕ_f respectively. It is given that $\phi_c \neq \phi_f$
- (a) ϕ_c cannot be equal to ϕ_d
 (b) ϕ_d can be equal to ϕ_e
 (c) $(\phi_d - \phi_f)$ is equal to $(\phi_c - \phi_e)$
 (d) $(\phi_d - \phi_c)$ is not equal to $(\phi_f - \phi_e)$
- (iii) Wavefront is the locus of all points, where the particles of the medium vibrate with the same
 (a) phase (b) amplitude
 (c) frequency (d) period
- (iv) A point source that emits waves uniformly in all directions, produces wavefronts that are
 (a) spherical (b) elliptical
 (c) cylindrical (d) planar

OR

What are the types of wavefronts ?

- (a) Spherical (b) Cylindrical
 (c) Plane (d) All of these

SECTION-E

- 31.** Is a displacement current associated with a magnetic field? Or, can a changing electric flux induce a magnetic field? Explain it with the help of an example.

OR

A parallel plate capacitor consists of two circular plates each of radius 2 cm separated by distance of 0.1 mm. If rate of change of potential difference is $5 \times 10^{13} \text{ V-s}^{-1}$, Find out the value of displacement current ?

- 32.** What is rectifier ? How a p - n junction diode can be used in (1) forward biased and (2) reverse biased mode ? Draw a labelled V - I characteristic of p - n junction diode on a graph.

OR

Draw the necessary energy band diagrams to distinguish between conductors, semiconductors and insulators. How does the change in temperature affect the behaviour of these materials? Explain briefly.

- 33.** Define self-inductance of a coil. Obtain the expression for the energy stored in an inductor L connected across a source of emf.

OR

A circular ring of area of 0.5 m^2 is situated in a non-uniform magnetic field of 4T changing in 2 s and making an angle of 60° with the magnetic field. What is the magnitude of the induced E.M.F.?

□□□□□□

CLICK HERE TO INSTALL NODIA APP



Sample Paper 18

Class XII 2024-25

Physics

Time: 3 Hours

Max. Marks: 70

General Instructions:

1. There are 33 questions in all. All questions are compulsory.
 2. This question paper has five sections: Section A, Section B, Section C, Section D and Section E.
 3. All the sections are compulsory.
 4. Section A contains sixteen questions, twelve MCQ and four assertion reasoning based of 1 mark each, Section B contains five questions of 2 marks each, Section C contains seven questions of 3 marks each, Section D contains two case study based questions of 4 marks each and Section E contains three long questions of 5 marks each.
 5. There is no overall choice. However, an internal choice has been provided in one question in Section B, one question in Section C, one question in each CBQ in Section D and all three questions in Section E. You have to attempt only one of the choices in such questions
 6. Use of calculators is not allowed.
 7. You may use the following values of physical constants where ever necessary
 - i. $c = 3 \times 10^8$ m/s
 - ii. $m_e = 9.1 \times 10^{-31}$ kg
 - iii. $e = 1.6 \times 10^{-19}$ C
 - iv. $\mu_0 = 4\pi \times 10^{-7}$ TmA⁻¹
 - v. $h = 6.63 \times 10^{-34}$ Js
 - vi. $\epsilon_0 = 8.854 \times 10^{-12}$ C²N⁻¹m⁻²
 - vii. Avogadro's number = 6.023×10^{23} per gram mole
-

SECTION-A

1. The value of 1 MeV is
 - (a) 1.6×10^{-19} J
 - (b) 1.6×10^{-16} J
 - (c) 1.6×10^{-13} J
 - (d) 1.6×10^{-11} J
2. Absorbed electrical energy is
 - (a) Proportional to the potential difference
 - (b) Inversely proportional to the potential difference
 - (c) Proportional to the square of the potential difference
 - (d) None of these
3. The AC voltage across a resistance can be measured using a
 - (a) Potentiometer
 - (b) Hot-wire voltmeter
 - (c) Moving-coil galvanometer
 - (d) Moving-magnet galvanometer

Continue on next page.....

CLICK HERE TO SEE ANSWERS



4. An increase in the conduction band increases conductivity of the metal. A proton moving with a velocity $2.5 \times 10^7 \text{ ms}^{-1}$, enters a magnetic field of intensity 2.5 T at an angle 30° with the magnetic field. The force on the proton is
- (a) $3 \times 10^{-12} \text{ N}$ (b) $5 \times 10^{-12} \text{ N}$
(c) $6 \times 10^{-12} \text{ N}$ (d) $9 \times 10^{-12} \text{ N}$
5. The best material for the core of a transformer is
- (a) soft iron (b) mild steel
(c) hard steel (d) stainless steel
6. A bar magnet is equivalent to a current-carrying
- (a) torroid (b) solenoid
(c) circular oil (d) straight conductor
7. Which of the following electromagnetic waves have the smallest wavelength?
- (a) γ -rays (b) X-rays
(c) UV waves (d) infra-red rays
8. Faraday's laws are the consequence of the conservation of
- (a) charge (b) energy
(c) magnetic field (d) both (b) and (c)
9. Three capacitors each of capacity C are connected in series. The resultant capacity will be
- (a) $3C$ (b) $3/C$
(c) $C/3$ (d) $1/3C$
10. The state of energy of the valence electrons, when the temperature is raised or when electric field is applied, is called
- (a) valence band (b) conduction band
(c) forbidden band (d) none of these
11. Which of the following is/are not electromagnetic waves?
- (a) β -rays (b) X-rays
(c) cosmic rays (d) both a and b
12. The specific charge of electron is
- (a) $1.8 \times 10^{-11} \text{ C/kg}$ (b) $1.8 \times 10^{-19} \text{ C/kg}$
(c) $1.9 \times 10^{-19} \text{ C/kg}$ (d) none of these

Continue on next page.....

CLICK HERE TO INSTALL NODIA APP

13. **Assertion :** In electric circuits, wires carrying currents in opposite directions are often twisted together.
Reason : If the wires are not twisted together, the combination of the wires forms a current loop, the magnetic field generated by the loop might affect adjacent circuits or components.
- (a) Both Assertion and Reason are correct and Reason is the correct explanation of Assertion.
 - (b) Both Assertion and Reason are correct, but Reason is not the correct explanation of Assertion.
 - (c) Assertion is correct but Reason is incorrect.
 - (d) Assertion is incorrect but Reason is correct.
14. **Assertion :** Diamagnetic materials can exhibit magnetism.
Reason : Diamagnetic materials have permanent magnetic dipole moment.
- (a) Both Assertion and Reason are correct and Reason is the correct explanation of Assertion.
 - (b) Both Assertion and Reason are correct, but Reason is not the correct explanation of Assertion.
 - (c) Assertion is correct but Reason is incorrect.
 - (d) Assertion is incorrect but Reason is correct.
15. **Assertion :** In series LCR circuit resonance can take place.
Reason : Resonance takes place if inductance and capacitive resistances are equal and opposite.
- (a) Both Assertion and Reason are correct and Reason is the correct explanation of Assertion.
 - (b) Both Assertion and Reason are correct, but Reason is not the correct explanation of Assertion.
 - (c) Assertion is correct but Reason is incorrect.
 - (d) Assertion is incorrect but Reason is correct.
16. **Assertion (A) :** If optical density of a substance is more than that of water, then the mass density of substance can be less than water.
Reason (R) : Optical density and mass density are not related.
- (a) Both Assertion and Reason are correct and Reason is the correct explanation of Assertion.
 - (b) Both Assertion and Reason are correct, but Reason is not the correct explanation of Assertion.
 - (c) Assertion is correct but Reason is incorrect.
 - (d) Assertion is incorrect but Reason is correct.

SECTION-B

17. If the horizontal and Vertical components of the earth's magnetic field are equal at a certain place, what would be the angle of dip at the place?
18. Explain briefly how electromagnetic waves are produced by an oscillating charge. How is the frequency of electromagnetic waves produced related to that of the oscillating charge?
19. For the same value of angle of incidence, the angles of refraction in three media A , B and C are 15° , 25° and 35° respectively. In which medium, would the velocity of light be minimum?

[CLICK HERE TO SEE ANSWERS](#)



20. Draw the magnetic field lines due to a current carrying loop.
21. State the principle of superposition of waves.

OR

What happens to fringe width, when the separation between the slits as well as distance of the screen from the slit are halved?

SECTION-C

22. Give two advantages of LED's over the conventional incandescent lamps.
23. Explain, with the help of a circuit diagram, the working of a $p - n$ junction diode as a half-wave rectifier.
24. Two copper spheres of radii r_1 and r_2 having charges q_1 and q_2 are connected by means of a wire. What is the electric conditions that no charge flows between them?
25. Conduction and displacement currents are individually discontinuous, but their sum is continuous.
26. How does the surface of the earth appear to a fish or a person sitting inside clear water?
27. Briefly describe proton-neutron hypothesis of nuclear composition.

OR

Explain how is fission an enormous source of energy per nuclear fission is about 200 MeV.

28. What is the ratio of radii of the orbits corresponding to first excited state and ground state, in a hydrogen atom?

Continue on next page.....

CLICK HERE TO INSTALL NODIA APP



SECTION-D

Case Study Based Questions.

Read the following paragraph and answer the questions that follow.

29. The potential barrier in the p - n junction diode is the barrier in which the charge requires additional force for crossing the region. In other words, the barrier in which the charge carrier stopped by the obstructive force is known as the potential barrier.

When a p -type semiconductor is brought into a close contact with n -type semiconductor, we get a p - n junction with a barrier potential 0.4 V and width of depletion region is $4.0 \times 10^{-7}\text{ m}$. This p - n junction is forward biased with a battery of voltage 3 V and negligible internal resistance, in series with a resistor of resistance R , ideal millimeter and key K as shown in figure. When key is pressed, a current of 20 mA passes through the diode.

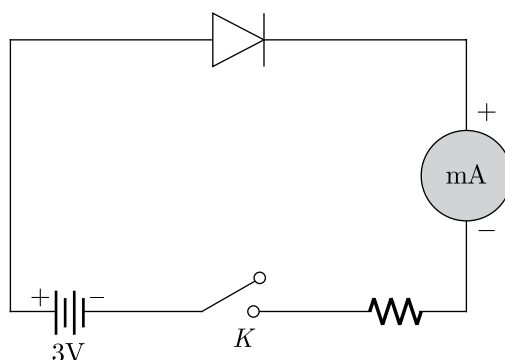

- (i) The intensity of the electric field in the depletion region when p - n junction is unbiased is
- (a) $0.5 \times 10^6\text{ Vm}^{-1}$
 - (b) $1.0 \times 10^6\text{ Vm}^{-1}$
 - (c) $2.0 \times 10^6\text{ Vm}^{-1}$
 - (d) $1.5 \times 10^6\text{ Vm}^{-1}$
- (ii) The resistance of resistor R is
- (a) $150\ \Omega$
 - (b) $300\ \Omega$
 - (c) $130\ \Omega$
 - (d) $180\ \Omega$
- (iii) In a p - n junction, the potential barrier is due to the charges on either side of the junction, these charges are
- (a) majority carriers
 - (b) minority carriers
 - (c) both (a) and (b)
 - (d) fixed donor and acceptor ions

CLICK HERE TO SEE ANSWERS



- (iv) If the voltage of the potential barrier is V_0 . A voltage V is applied to the input, at what moment will the barrier disappear?
- $V < V_0$
 - $V = V_0$
 - $V > V_0$
 - $V \ll V_0$

OR

If an electron with speed $4.0 \times 10^5 \text{ ms}^{-1}$ approaches the p - n junction from the n -side, the speed with which it will enter the p -side is

- $1.39 \times 10^5 \text{ ms}^{-1}$
 - $2.78 \times 10^5 \text{ ms}^{-1}$
 - $1.39 \times 10^6 \text{ ms}^{-1}$
 - $2.78 \times 10^6 \text{ ms}^{-1}$
- 30.** If double slit apparatus is immersed in a liquid of refractive index, μ the wavelength of light reduces to λ' and fringe width also reduces to $\beta' = \frac{\beta}{\mu}$. The given figure shows a double-slit experiment in which coherent monochromatic light of wavelength λ from a distant source is incident upon the two slits, each of width $w (w \gg \lambda)$ and the interference pattern is viewed on a distant screen. A thin piece of glass of thickness t and refractive index n is placed between one of the slit and the screen, perpendicular to the light path.

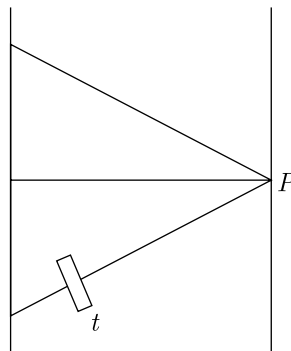

- In Young's double slit interference pattern, the fringe width
 - can be changed only by changing the wavelength of incident light
 - can be changed only by changing the separation between the two slits
 - can be changed either by changing the wavelength or by changing the separation between two sources
 - is a universal constant and hence cannot be changed

Continue on next page.....

CLICK HERE TO INSTALL NODIA APP



- (ii) If the width w of one of the slits is increased to $2w$, the become the amplitude due to slit
- (a) $1.5a$
 - (b) $a/2$
 - (c) $2a$
 - (d) no change
- (iii) In $YDSE$, let A and B be two slits. Films of thicknesses t_A and t_B and refractive indices m_A and m_B are placed in front of A and B , respectively. If $\mu_A t_A = \mu_B t_B$, then the central maxima will
- (a) Not shift
 - (b) Shift towards A
 - (c) Shift towards B
 - (d) Shift towards A if $t_B = t_A$ and shift towards B if $t_B < t_A$
- (iv) In Young's double slit experiment, a third slit is made in between the double slits. Then
- (a) Fringes of unequal width are formed
 - (b) Contrast between bright and dark fringes is reduced
 - (c) Intensity of fringes totally disappears
 - (d) Only bright light is observed on the screen.

OR

In Young's double slit experiment, if one of the slits is covered with a microscope cover slip, then

- (a) Fringe pattern disappears
- (b) The screen just gets illuminated
- (c) In the fringe pattern, the brightness of the bright fringes will decreases and the dark fringes will become more dark
- (d) Bright fringes will be more bright and dark fringes will become more dark.

SECTION-E

- 31.**
1. State and explain Superposition Principle.
 2. Find an expression for the total force acting on a given charge due to a number of other charges, when the source charges are point charges.

OR

A thin metallic spherical shell of radius R carries a charge Q on its surface. A point charge $\frac{Q}{2}$ is placed at the centres C and other charge $+2Q$ is placed outside the shell at A at a distance X from the centre as shown in the figure.

CLICK HERE TO SEE ANSWERS



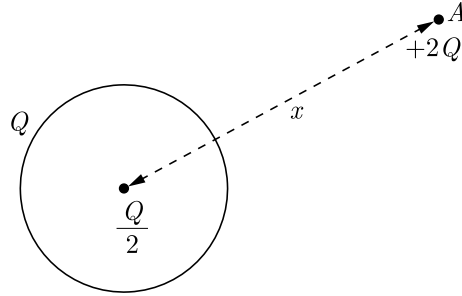

- (i) Find the electric flux through the shell.
 - (ii) State the law used.
 - (iii) Find the force on the charges at the centre C of the shell and at the point A .
- 32.** What is the energy level diagram for an atom? Calculate the energies of the various energy levels of a hydrogen atom and draw an energy level diagram for it.

OR

In the ground state of hydrogen atom, its Bohr radius is given as $5.3 \times 10^{-11}\text{m}$. The atom is excited such that the radius becomes $21.2 \times 10^{-11}\text{m}$. Find:

1. The value of the principal quantum number.
 2. Total energy of the atom in this excited state.
- 33.** Sketch the magnetic lines of force of straight current carrying conductor. State the rules used to find the direction of this magnetic field.

OR

Derive an expression for the force per unit length between two long straight parallel current carrying conductors. Hence define SI unit of current (ampere).

□□□□□□



Sample Paper 19

Class XII 2024-25

Physics

Time: 3 Hours

Max. Marks: 70

General Instructions:

1. There are 33 questions in all. All questions are compulsory.
 2. This question paper has five sections: Section A, Section B, Section C, Section D and Section E.
 3. All the sections are compulsory.
 4. Section A contains sixteen questions, twelve MCQ and four assertion reasoning based of 1 mark each, Section B contains five questions of 2 marks each, Section C contains seven questions of 3 marks each, Section D contains two case study based questions of 4 marks each and Section E contains three long questions of 5 marks each.
 5. There is no overall choice. However, an internal choice has been provided in one question in Section B, one question in Section C, one question in each CBQ in Section D and all three questions in Section E. You have to attempt only one of the choices in such questions
 6. Use of calculators is not allowed.
 7. You may use the following values of physical constants where ever necessary
 - i. $c = 3 \times 10^8$ m/s
 - ii. $m_e = 9.1 \times 10^{-31}$ kg
 - iii. $e = 1.6 \times 10^{-19}$ C
 - iv. $\mu_0 = 4\pi \times 10^{-7}$ TmA⁻¹
 - v. $h = 6.63 \times 10^{-34}$ Js
 - vi. $\epsilon_0 = 8.854 \times 10^{-12}$ C²N⁻¹m⁻²
 - vii. Avogadro's number = 6.023×10^{23} per gram mole
-

SECTION-A

1. If a current of 300 mA is flowing in a conductor, then the number of electrons passed through the conductor in 4 min. is (Charge on an electron = 1.6×10^{-19} C)
 - (a) 4.5×10^{20}
 - (b) 9.0×10^{20}
 - (c) 4.5×10^{18}
 - (d) 9.0×10^{18}
2. Two point charge Q and $-2Q$ are placed at some distance apart. If the electric field at the location of Q is E , then the electric field at the location of $-2Q$ will be
 - (a) $-\frac{E}{2}$
 - (b) $-\frac{3E}{2}$
 - (c) $-E$
 - (d) $-2E$
3. The total energy of an electron in the first excited state of hydrogen atom is about -3.4 eV. Its kinetic energy in this state is
 - (a) -3.4 eV
 - (b) 3.4 eV
 - (c) -6.8 eV
 - (d) 6.8 eV
4. The direction of null points are on the equatorial line of a bar magnet, when the north pole of the magnet is pointing towards

[CLICK HERE TO SEE ANSWERS](#)



- (a) north (b) south
(c) east (d) west
5. The electric potential due to a small electric dipole at a large distance r from the center of the dipole is proportional to
(a) r (b) $\frac{1}{r}$
(c) $\frac{1}{r^2}$ (d) $\frac{1}{r^3}$
6. Two thin, long, parallel wires, separated by a distance d carry a current of (i) A in the same direction. They will
(a) attract each other with a force of $\mu_0 i^2 / (2\pi d)$ (b) repel each other with a force of $\mu_0 i^2 / (2\pi d)$
(c) attract each other with a force of $\mu_0 i^2 / (2\pi d^2)$ (d) repel each other with a force of $\mu_0 i^2 / (2\pi d^2)$
7. When a compact disc is illuminated by a source of white light, coloured lanes are observed. This is due to
(a) dispersion (b) diffraction
(c) interference (d) refraction
8. If a wire of length 2 m is moving with a velocity of $1 \text{ m}\cdot\text{s}^{-1}$ perpendicular to a magnetic field of 0.5 T, then E.M.F. induced in the wire will be
(a) 0.2 V (b) 0.5 V
(c) 1 V (d) 2 V
9. There are n_1 photons of frequency ν_1 in a beam of light. In an equally energetic beam, there are n_2 photons of frequency ν_2 . Their correct relation is
(a) $\frac{n_1}{n_2} = 1$ (b) $\frac{n_1}{n_2} = \frac{\nu_1}{\nu_2}$
(c) $\frac{n_1}{n_2} = \frac{\nu_2}{\nu_1}$ (d) $\frac{n_1}{n_2} = \frac{\nu_1^2}{\nu_2^2}$
10. Two long straight parallel conductors separated by a distance of 0.5 m carry currents of 5 A and 8 A in the same direction. The force per unit length experienced by each other is
(a) $1.6 \times 10^{-5} \text{ N}$ (attractive) (b) $1.6 \times 10^{-5} \text{ N}$ (repulsive)
(c) $16 \times 10^{-5} \text{ N}$ (attractive) (d) $16 \times 10^{-5} \text{ N}$ (repulsive)
11. An electromagnetic wave of frequency 3 MHz passes from vacuum into a medium with dielectric constant $k = 4$. Then
(a) both wavelength and frequency remain unchanged
(b) wavelength is doubled and frequency becomes half
(c) wavelength is halved and frequency remains unchanged
(d) wavelength is doubled and the frequency remains unchanged
12. A conducting rod of length $2l$ is rotating with a constant angular speed ω about its perpendicular bisector as shown in the figure. A uniform magnetic field B exists parallel to the axis of rotation. The E.M.F. induced between two ends of the rod is



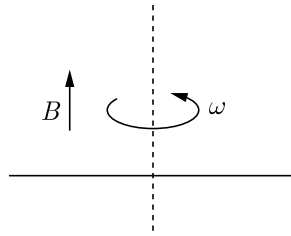

- (a) zero
- (b) $B\omega l^2$
- (c) $\frac{1}{2}B\omega l^2$
- (d) $\frac{1}{8}B\omega l^2$

13. **Assertion :** Thin films such a soap bubble or a thin layer of oil on water show beautiful colours when illuminated by white light.

Reason : It happens due to the interference of light reflected from the upper surface of the thin film.

- (a) Both Assertion and Reason are correct and the Reason is a correct explanation of the Assertion.
- (b) Both Assertion and Reason are correct but Reason is not a correct explanation of the Assertion.
- (c) The Assertion is correct but Reason is incorrect.
- (d) Both the Assertion and Reason are incorrect.

14. **Assertion :** Mass of moving photon varies inversely as the wavelength.

Reason : Energy of the particle = mass \times (speed of light)²

- (a) Both Assertion and Reason are correct and the Reason is a correct explanation of the Assertion.
- (b) Both Assertion and Reason are correct but Reason is not a correct explanation of the Assertion.
- (c) The Assertion is correct but Reason is incorrect.
- (d) Both the Assertion and Reason are incorrect.

15. **Assertion (A) :** No two electric lines of force can intersect each other.

Reason (R) : Tangent at any point of electric line of force gives the direction of electric field.

- (a) Both Assertion and Reason are correct and the Reason is a correct explanation of the Assertion.
- (b) Both Assertion and Reason are correct but Reason is not a correct explanation of the Assertion.
- (c) The Assertion is correct but Reason is incorrect.
- (d) Both the Assertion and Reason are incorrect.

16. **Assertion :** The value of current through $p - n$ junction in the given figure will be 10 mA.

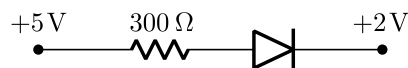

Reason : In the above figure, p -side is at higher potential than n -side.

- (a) Both Assertion and Reason are correct and the Reason is a correct explanation of the Assertion.
- (b) Both Assertion and Reason are correct but Reason is not a correct explanation of the Assertion.
- (c) The Assertion is correct but Reason is incorrect.
- (d) Both the Assertion and Reason are incorrect.

Continue on next page.....

CLICK HERE TO SEE ANSWERS



SECTION-B

17. State two characteristic properties distinguishing behaviour of paramagnetic and diamagnetic materials.
18. A ray of light passes through an equilateral glass prism such that the angle of incidence is equal to angle of emergence and each of these angles is equal to $\frac{3}{4}$ of angle of prism. What is the value of deviation?
19. What are isotones and isomers? Give suitable examples.
20. Distinguish between *n*-type and *p*-type semiconductors.

or

The graph shown in the figure represents a plot of current versus voltage for a given semiconductor. Identify the region at which the semiconductor has a negative resistance.

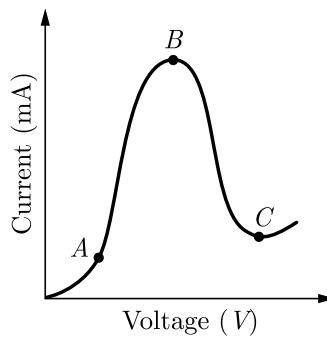

21. How are electromagnetic waves produced? What is the source of energy of these waves? Write mathematical expressions for electric and magnetic fields of an electromagnetic wave propagating along the *z*-axis. Write any two important properties of electromagnetic waves.

SECTION-C

22. A metal rod makes contact and completes the circuit as shown in the figure. The direction of motion of rod is perpendicular to the magnetic field of 0.5 T. If the resistance *R* is 2 Ω. What is the force needed to move the rod as indicated with a constant velocity of 8 m·s⁻¹ ?

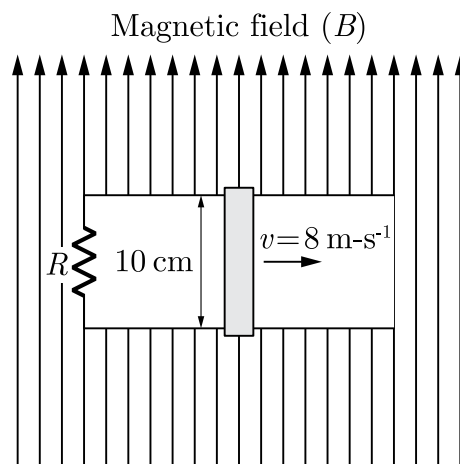

23. An applied voltage signal consists of a superposition of a DC voltage of high frequency. The circuit consists of an inductor and a capacitor in series. Show the DC signal will appear across C and the AC voltage across L .
24. Draw the circuit diagram of a full-wave rectifier using $p-n$ junction diode. Explain its working and show the output input waveforms.
25. A hydrogen atom initially in its ground absorbs a photon and is in the excited state with energy 12.5 eV. Calculate the longest wavelength of the radiation emitted and identify the series to which it belongs. [Take Rydberg constant $R = 1.1 \times 10^7 \text{m}^{-1}$]
26. How does a combination of lenses affect the size, position and nature of the image?
27. Describe the construction and work of a photocell (or photo-emissive cell).

OR

The given graph shows the variation of photoelectric current I versus applied voltage V for two different photosensitive materials and for two different intensities of the incident radiations. Identify the pairs of curves that corresponds to different materials but same intensity of incident radiation.

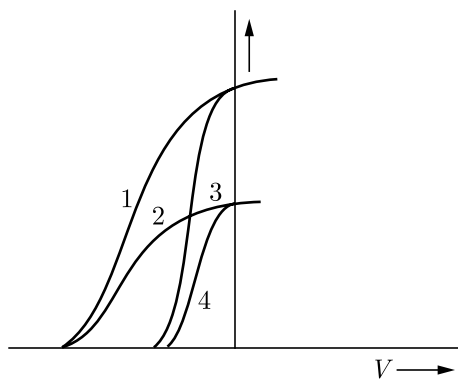

28. State the factors on which the force acting on a charge moving in a magnetic field depends. Write the expression for this force. When is this force minimum and maximum?

SECTION-D

Case Study Based Questions.

Read the following paragraph and answer the questions that follow.

29. Rectifier is a device which is used for converting alternating current or voltage into direct current or voltage. Its working is based on the fact that the resistance of $p-n$ junction becomes low when forward biased and becomes high when reverse biased. A half-wave rectifier uses only a single diode while a full wave rectifier uses two diodes as shown in figures (a) and (b).

[CLICK HERE TO SEE ANSWERS](#)



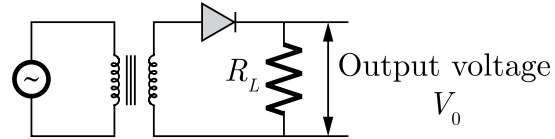

(a) Half wave rectifier

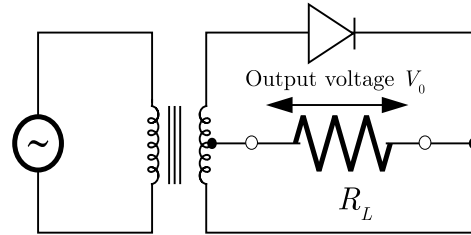

(b) Full Wave rectifier

- (i) If the rms value of sinusoidal input to a full wave rectifier is $\frac{V_0}{\sqrt{2}}$ then the rms value of the rectifier's output is
- (a) $\frac{V_0}{\sqrt{2}}$ (b) $\frac{V_0^2}{\sqrt{2}}$
 (c) $\frac{V_0^2}{2}$ (d) $\sqrt{2} V_0^2$
- (ii) In the diagram, the input ac is across the terminals A and C . The output across B and D is

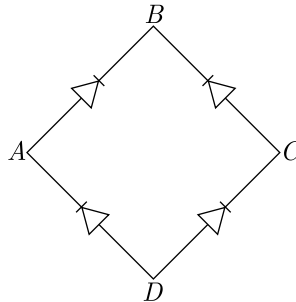

- (a) same as the input (b) half wave rectified
 (c) zero (d) full wave rectified
- (iii) A bridge rectifier is shown in figure. Alternating input is given across A and C . If output is taken across BD , then it is

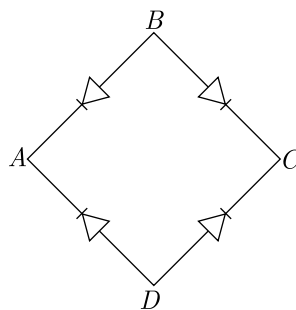

- (a) zero (b) same as input
 (c) half wave rectified (d) full wave rectified



- (iv) A $p-n$ junction (D) shown in the figure can act as a rectifier. An alternating current source (V) is connected in the circuit. The current (I) in the resistor (R) can be shown by

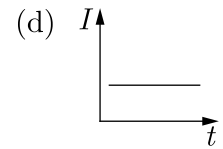
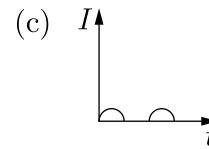
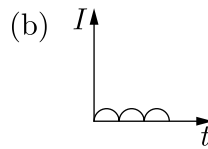
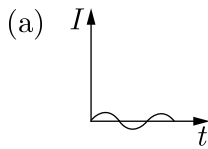
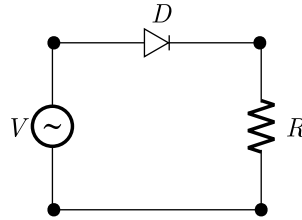

OR

With an ac input from 50 Hz power line, the ripple frequency is

- (a) 50 Hz in the dc output of half wave as well as full wave rectifier
 (b) 100 Hz in the dc output of half wave as well as full wave rectifier
 (c) 50 Hz in the dc output of half wave and 100 Hz in dc output of full wave rectifier
 (d) 100 Hz in the dc output of half wave and 50 Hz in the dc output of full wave rectifier.
30. Total internal reflection is the phenomenon of reflection of light into denser medium at the interface of denser medium with a rarer medium. For this phenomenon to occur necessary condition is that light must travel from denser to rarer and angle of incidence in denser medium must be greater than critical angle (C) for the pair of media in contact. Critical angle depends on nature of medium and wavelength of light. We can show that $\mu = \frac{1}{\sin C}$
- (i) Critical angle for glass air interface, where μ , of glass is $3/2$, is
 (a) 41.8° (b) 60°
 (c) 30° (d) 15°
- (ii) Critical angle for water air interface is 48.6° . What is the refractive index of water?
 (a) 1 (b) $3/2$
 (c) $4/3$ (d) $3/4$
- (iii) Critical angle for air water interface for violet colour is 49° . Its value for red colour would be
 (a) 49° (b) 50°
 (c) 48° (d) cannot say
- (iv) Which of the following is not due to total internal reflection?
 (a) Working of optical fibre.
 (b) Difference between apparent and real depth of a pond.
 (c) Mirage on hot summer days.
 (d) Brilliance of diamond.



OR

Critical angle of glass is θ_1 and that of water is θ_2 . The critical angle for water and glass surface would be ($\mu_g = 3/2$, $\mu_w = 4/3$).

- (a) less than θ_2 (b) between θ_1 and θ_2
 (c) greater than θ_2 (d) less than θ_1

SECTION-E

31. Two uniformly large parallel thin plates having charge densities $+\sigma$ and $-\sigma$ are kept in the $X-Z$ plane at a distance d apart. Sketch and equipotential surface due to electric field between the plates. If a particle of mass m and charge $-q$ remains stationary between the plates, what is the magnitude and direction of this field ?

or

Find the electric potential and then electric field due to an electric dipole by differential relationship between field and potential.

32. Two wavelengths of sodium light 590 nm and 596 nm are used, in turn, to study the diffraction taking place at a single slit of aperture 2×10^{-4} m. The distance between the slit and the screen is 1.5 m. Calculate the separation between the positions of the first maxima of the diffraction pattern obtained in the two cases.

or

- (i) State the essential conditions for diffraction of light.
 (ii) Explain diffraction of light due to a narrow single slit and the formation of pattern of fringes on the screen.
 (iii) Find the relation for width of central maximum in terms of wavelength λ , width of slit a , and separation between slit and screen D .
 (iv) If the width of the slit is made double the original width, how does it affect the size and intensity of the central band?

33.

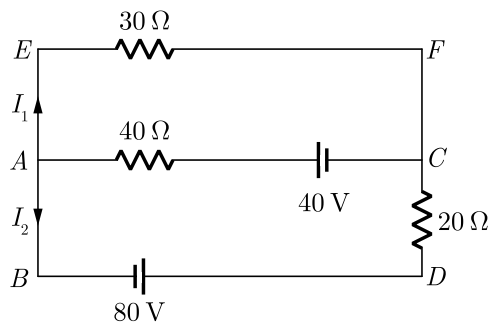

- (i) Using Kirchhoff's rules, calculate the current in the arm AC of the given circuit.
 (ii) On what principle does the meter bridge work? Why are the metal strips used in the bridge?

or

Define the terms drift velocity and relaxation time. Establish the relation between drift velocity of electrons and electric field applied to the conductor.

□□□□□□□□



Sample Paper 20

Class XII 2024-25

Physics

Time: 3 Hours

Max. Marks: 70

General Instructions:

1. There are 33 questions in all. All questions are compulsory.
 2. This question paper has five sections: Section A, Section B, Section C, Section D and Section E.
 3. All the sections are compulsory.
 4. Section A contains sixteen questions, twelve MCQ and four assertion reasoning based of 1 mark each, Section B contains five questions of 2 marks each, Section C contains seven questions of 3 marks each, Section D contains two case study based questions of 4 marks each and Section E contains three long questions of 5 marks each.
 5. There is no overall choice. However, an internal choice has been provided in one question in Section B, one question in Section C, one question in each CBQ in Section D and all three questions in Section E. You have to attempt only one of the choices in such questions
 6. Use of calculators is not allowed.
 7. You may use the following values of physical constants where ever necessary
 - i. $c = 3 \times 10^8$ m/s
 - ii. $m_e = 9.1 \times 10^{-31}$ kg
 - iii. $e = 1.6 \times 10^{-19}$ C
 - iv. $\mu_0 = 4\pi \times 10^{-7}$ TmA⁻¹
 - v. $h = 6.63 \times 10^{-34}$ Js
 - vi. $\epsilon_0 = 8.854 \times 10^{-12}$ C²N⁻¹m⁻²
 - vii. Avogadro's number = 6.023×10^{23} per gram mole
-

SECTION-A

1. Two coils are placed close to each other. The mutual inductance of the pair of coils depends upon
 - (a) currents in the coils
 - (b) materials of the wires of the coils
 - (c) relative position and orientation of the coils
 - (d) rates at which the currents are changing in the coils
2. Mass of a photon of frequency ν is given by
 - (a) $m = \frac{h}{\lambda}$
 - (b) $m = \frac{h\nu}{c}$
 - (c) $m = \frac{h\nu}{c}$
 - (d) $m = \frac{h\nu}{c^2}$
3. At the magnetic poles of the earth, a compass needle will be
 - (a) vertical
 - (b) horizontal
 - (c) inclined at 10° with the vertical
 - (d) inclined at 45° with the horizontal
4. If the length of a conductor is halved, then its conductance will be
 - (a) halved
 - (b) doubled
 - (c) quadrupled
 - (d) unchanged

[CLICK HERE TO SEE ANSWERS](#)



5. A proton is moving in a space with constant velocity in an electric field E and magnetic field B . The angle between electric field and magnetic field should be
- (a) 0° (b) 30°
(c) 45° (d) 90°
6. In some substances, charge can flow at ordinary temperature, but not at very low temperatures. These substances are called
- (a) conductors (b) insulators
(c) dielectrics (d) semiconductors
7. The ratio of no. of turns of primary coil to secondary coil in a transformer is 2:3. If a cell of 6 V is connected across the primary coil, then voltage across the secondary coil will be
- (a) 3 V (b) 6 V
(c) 9 V (d) 12 V
8. The electrostatic energy stored in a capacitor is
- (a) $\frac{1}{2} QV$ (b) $\frac{1}{QV}$
(c) $\frac{2}{QV}$ (d) QV
9. Reactance of a capacitor of capacitance C for an alternating current of frequency $\frac{400}{\pi}$ Hz is 25Ω . The value of C is
- (a) $25 \mu\text{F}$ (b) $50 \mu\text{F}$
(c) $75 \mu\text{F}$ (d) $100 \mu\text{F}$
10. Two charged spheres separated by a distance d exert some force F on each other. If they are immersed in a liquid of dielectric constant 4, then what is the force exerted, if all other conditions are same?
- (a) $2F$ (b) $4F$
(c) $\frac{F}{2}$ (d) $\frac{F}{4}$
11. Which of the following electromagnetic waves have the smallest wavelength?
- (a) γ -rays (b) X-rays
(c) UV waves (d) infra-red rays
12. When two converging lenses of same focal f are placed in contact, the focal length of the combination is
- (a) f (b) $2f$
(c) $\frac{f}{2}$ (d) $3f$

Continue on next page.....

CLICK HERE TO INSTALL NODIA APP

13. **Assertion :** The ferromagnetic substance do not obey Curie's law.
Reason : At Curie point a ferromagnetic substance start behaving as a paramagnetic substance.
- (a) Both Assertion and Reason are correct and Reason is the correct explanation of Assertion.
(b) Both Assertion and Reason are correct, but Reason is not the correct explanation of Assertion.
(c) Assertion is correct but Reason is incorrect.
(d) Assertion is incorrect but Reason is correct.
14. **Assertion (A) :** The whole charge of a conductor cannot be transferred to another isolated conductor.
Reason (R) : The total transfer of charge from one to another is not possible.
- (a) Both Assertion and Reason are correct and Reason is the correct explanation of Assertion.
(b) Both Assertion and Reason are correct, but Reason is not the correct explanation of Assertion.
(c) Assertion is correct but Reason is incorrect.
(d) Assertion is incorrect but Reason is correct.
15. **Assertion :** The magnetic field at the centre of the circular coil in the following figure due to the currents I_1 and I_2 is zero.

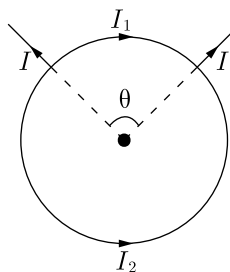

Reason : $I_1 = I_2$ implies that the fields due to the current I_1 and I_2 will be balanced.

- (a) Both Assertion and Reason are correct and Reason is the correct explanation of Assertion.
(b) Both Assertion and Reason are correct, but Reason is not the correct explanation of Assertion.
(c) Assertion is correct but Reason is incorrect.
(d) Assertion is incorrect but Reason is correct.
16. **Assertion :** Long distance power transmission is done at high voltage.
Reason : At high voltage supply power losses are less.
- (a) Both Assertion and Reason are correct and Reason is the correct explanation of Assertion.
(b) Both Assertion and Reason are correct, but Reason is not the correct explanation of Assertion.
(c) Assertion is correct but Reason is incorrect.
(d) Assertion is incorrect but Reason is correct.

Continue on next page.....

CLICK HERE TO SEE ANSWERS



SECTION-B

17. Find the wavelength of electromagnetic waves of frequency 6×10^{12} Hz in free space. Give its two applications.
18. The focal length of a equiconvex lens is equal to the radius of curvature of either face. What is the value of refractive index of the material of the lens ?
19. Write the expression, in a vector form, for the Lorentz magnetic force \vec{F} due to a charge moving with velocity \vec{v} in a magnetic field \vec{B} . What is the direction of the magnetic force ?
20. Light from two coherent sources is reaching the screen. If the path difference at a point on the screen for the yellow light be $\frac{3\lambda}{2}$, then what will be the colour of the fringe at that point?

OR

What will be the effect of interference fringes if red light is replaced by blue light ?

21. Why cannot two magnetic lines of forces due to a bar magnet cross each other?

SECTION-C

22. Draw the circuit diagram of a full-wave rectifier using $p - n$ junction diode. Explain its working and show the output input waveforms.
23. Atomic radius of first orbit of hydrogen atom is 0.53 \AA . What is the radius of its fifth orbit?
24. The $V - I$ characteristic of a silicon diode is as shown in the figure. Calculate the resistance of the diode at
 (i) $I = 15 \text{ mA}$
 (ii) $V = -10 \text{ V}$.

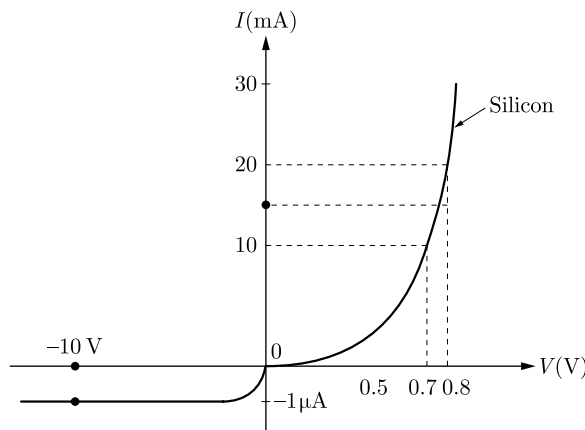

Continue on next page.....

CLICK HERE TO INSTALL NODIA APP



25. What is polarization of charge? With the help of a diagram show why the electric field between the plates of capacitor reduces on introducing a dielectric slab. Define the dielectric constant on the basis of these fields.
26. When an ideal capacitor is charged AC by a DC battery, no current flows. However, when an AC source is used, the current flows continuously. How does one explain this, based on the concept of displacement current ?
27. How does a combination of lenses affect the size, position and nature of the image?
28. State the important properties of neutrons.

OR

Answer the following:

- (i) Why is the binding energy per nucleon found to be constant for nuclei in the range of mass number A lying between 30 and 170?
- (ii) When a heavy nucleus with mass number $A = 240$ breaks into two nuclei, $A = 120$, energy is released in the process.

SECTION-D

29. Electric field strength is proportional to the density of lines of force *i.e.*, electric field strength at a point is proportional to the number of lines of force cutting a unit area element placed normal to the field at that point. As illustrated in the given figure, the electric field at P is stronger than at Q .

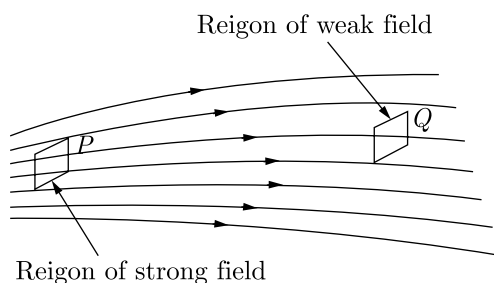

- (i) Electric lines of force about a positive point charge are
- radially outwards
 - circular clockwise
 - radially inwards
 - parallel straight lines.
- (ii) Which of the following is false for electric lines of force?
- They always start from positive charges and terminate on negative charges.
 - They are always perpendicular to the surface of a charged conductor.
 - They always form closed loops.
 - They are parallel and equally spaced in a region of uniform electric field.

[CLICK HERE TO SEE ANSWERS](#)



(iii) Which one of the following pattern of electric line of force is not possible in field due to stationary charges ?

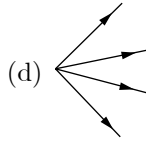
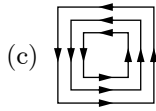
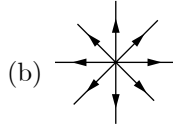
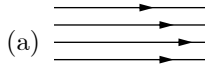

(iv) Electric lines of force are curved

- (a) in the field of a single positive or negative charge
- (b) in the field of two equal and opposite charges
- (c) in the field of two like charges
- (d) both (b) and (c)

OR

The figure below shows the electric field lines due to two positive charges. The magnitudes E_A , E_B and E_C of the electric fields at points A , B and C respectively are related as

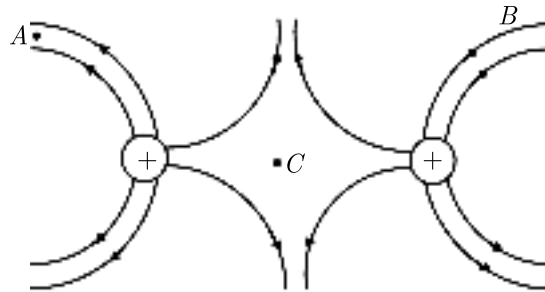

- (a) $E_A > E_B > E_C$
- (b) $E_B > E_A > E_C$
- (c) $E_A = E_B > E_C$
- (d) $E_A > E_B = E_C$

30. A narrow tube is bent in the form of a circle of radius R , as shown in figure. Two small holes S and D are made in the tube at the positions at right angle to each other. A source placed at S generates a wave of intensity I_0 which is equally divided into two parts: one part travels along the longer path, while the other travels along the shorter path. Both the waves meet at point D where a detector is placed.

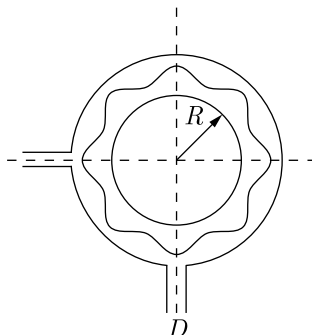

- (i) If a maxima is formed at a detector, then the magnitude of wavelength λ of the wave produced is given by
- (a) πR (b) $\frac{\pi R}{2}$
(c) $\frac{\pi R}{4}$ (d) all of these
- (ii) If the intensity ratio of two coherent sources used in Young's double slit experiment is 49 : 1, then the ratio between the maximum and minimum intensities in the interference pattern is
- (a) 1 : 9 (b) 9 : 16
(c) 25 : 16 (d) 16 : 9
- (iii) The maximum intensity produced at D is given by
- (a) $4I_0$ (b) $2I_0$
(c) I_0 (d) $3I_0$
- (iv) In a Young's double slit experiment, the intensity at a point where the path difference is $\lambda/6$ (λ – wavelength of the light) is I . If I_0 denotes the maximum intensity, then I/I_0 is equal to
- (a) $\frac{1}{2}$ (b) $\frac{\sqrt{3}}{2}$
(c) $\frac{1}{\sqrt{2}}$ (d) $\frac{3}{4}$

OR

Two identical light waves, propagating in the same direction, have a phase difference d . After they superpose the intensity of the resulting wave will be proportional to

- (a) $\cos \delta$ (b) $\cos(\delta/2)$
(c) $\cos^2(\delta/2)$ (d) $\cos^2 \delta$

SECTION-E

31. (i) State Gauss theorem.
(ii) Apply this to obtain the expression for the electric field intensity at a point due to an infinitely long, thin, uniformly charged straight wire.

OR

Two spherical conductors of radii 4 cm and 5 cm are charged to the same potential. If σ_1 and σ_2 be the respective values of the surface density of charge on both the conductors, What is the ratio of $\frac{\sigma_1}{\sigma_2}$?

32. (i) State Bohr's quantization condition for defining stationary orbits. How does the Broglie hypothesis, explain the stationary orbits?
(ii) Find the relation between the three wavelengths λ_1 , λ_2 and λ_3 from the energy level diagram shown below.

CLICK HERE TO SEE ANSWERS



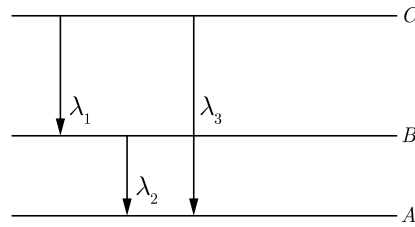

OR

- (i) The radius of the innermost electron orbit of a hydrogen atom is 5.3×10^{-11} m. Calculate its radius in $n = 3$ orbit.
- (ii) The total energy of an electron in the first excited state of the hydrogen atom, is -3.4 eV. Find out its (a) kinetic energy and (b) potential energy in this state.

- 33.** Two long straight parallel conductors carrying steady currents I_1 and I_2 are separated by a distance r . Explain briefly, with the help of a suitable diagram, how the magnetic field due to one conductor acts on the other. Hence deduce the expression for the force acting between the two conductors. Mention the nature of the force.

OR

- (i) Explain principle and working of a moving coil galvanometer. Derive an expression for current sensitivity.
- (ii) Compare between moving coil galvanometer and moving magnet galvanometer.

□□□□□□

