

# **General Development Rules 2023 for Daman District of Union Territory of Dadra and Nagar Haveli and Daman and Diu**

## **CHAPTER 14 – Fire Rules**

### **PART 3 (II)**

**Framed under Section 30, 140 (y) and 141 of  
The Dadra and Nagar Haveli and Daman and Diu Town & Country  
Planning Act, 1974 (Amended from time to time).**

**Daman Planning and Development Authority  
Union Territory Administration of Dadra and Nagar Haveli,  
Daman & Diu**

# **General Development Rules 2023 for Daman District of Union Territory of Dadra and Nagar Haveli and Daman and Diu**

## **CHAPTER 14 – Fire Rules**

### **PART 3 (II)**

**Framed under Section 30, 140 (y) and 141 of  
The Dadra and Nagar Haveli and Daman and Diu Town & Country  
Planning Act, 1974 (Amended from time to time).**

**Daman Planning and Development Authority  
Union Territory Administration of Dadra and Nagar Haveli,  
Daman & Diu**



## 14 Fire Prevention, Life Safety and Fire Protection Requirements

### 14.1 General

14.1.1 Scope

14.1.2 Definitions

- 1 Fire Detection and Alarm System
- 2 Combustible Material
- 3 Down-comer
- 4 Dry Riser
- 5 Emergency Lighting
- 6 Emergency Lighting System
- 7 Escape Lighting
- 8 Evacuation Lift
- 9 Exit
- 10 Fire Barrier (or Fire Resisting Barrier)
- 11 Fire Compartment
- 12 Fire Door / Fire Resistant door
- 13 Fire Exit
- 14 Firefighting Shaft (Fire Tower)
- 15 Fire Load
- 16 Fire Load Density
- 17 Fire/Fireman's Lift
- 18 Fire Resistance
- 19 Fire Resistance Rating
- 20 Fire Resistant Wall
- 21 Fire Separation
- 22 Fire Stop
- 23 Fire Suppression Systems
- 24 Fire Wall or Fire Separating Wall
- 25 Fire Exit Hardware
- 26 Lift Lobby
- 27 Means of Egress
- 28 Occupant Load
- 29 Place of Comparative Safety
- 30 Pressurization:
- 31 Pressurization Level
- 32 Ramp
- 33 Refuge Area
- 34 Roof Exits
- 35 Smoke Barrier
- 36 Smoke Compartment
- 37 Stack Pressure
- 38 Travel Distance
- 39 Venting Fire
- 40 Visual Strobes/Flashing
- 41 Water Based Systems
- 42 Wet Riser

14.1.3 Procedure for Clearance from Fire and Emergency Services for Development  
Permission and Occupancy Certificate

14.1.4 (*Deleted*)

14.1.5 Fees

14.1.6 Penalties

## **14.2 Fire Prevention**

- 14.2.1 Classification of Buildings Based on Occupancy
- 14.2.2 Fire Divisions
- 14.2.3 Types of Building Construction
- 14.2.4 General Requirements of All individual Occupancies

## **14.3 Life Safety**

- 14.3.1 General
- 14.3.2 General Exit Requirements
- 14.3.3 Occupant Load
- 14.3.4 Egress Components
- 14.3.5 Compartmentation
- 14.3.6 Smoke Control
- 14.3.7 Gas Supply
- 14.3.8 Hazardous Areas, Gaseous, Oil Storage Yard, etc
- 14.3.9 Fire Detection and Alarm
- 14.3.10 Fire Officer
- 14.3.11 Fire Drills and Fire Orders

## **14.4 Fire Protection**

- 14.4.1 Fire Extinguishers/ Fixed Firefighting Installations
- 14.4.2 Fire Detection and Alarm System

## **14.5 Additional Occupancy wise Requirements**

- 14.5.1 Residential Buildings (Group A)
- 14.5.2 Hospitality Buildings (Group B)
- 14.5.3 Educational Buildings (Group C)
- 14.5.4 Health and Public Buildings (Group D)
- 14.5.5 Assembly Buildings (Group E)
- 14.5.6 Transportation (Group F)
- 14.5.7 Storage Buildings (Group G)
- 14.5.8 Mercantile Buildings (Group H)
- 14.5.9 Business Buildings (Group I)
- 14.5.10 Industrial Buildings (Group J)

## **Annexures**

Annexure A: Calorific Value of Common Materials

Annexure B: Broad Classification of Industrial Occupancies

Annexure C: Available Data regarding Fire Resistance Rating of various Building Components

Annexure D: Guidelines for Fire Drill and Evacuation procedures for High Rise Buildings

Annexure E: Additional Requirements for High Rise Buildings

Annexure F: Atrium

Annexure G: Commercial Kitchens

Annexure H: Car Parking Facilities

Annexure J: Fire Protection Considerations for Venting in Industrial Buildings

Annexure K: List of Standards

## Table

Table No. 14.1	Classification of Buildings Based on Occupancy and Fire Division
Table No. 14.2	Fire Divisions
Table No. 14.3	Fire Resistance Ratings of Structural and Non-Structural Elements (minutes)
Table No. 14.4	Surface Material details for various uses as per class
Table No. 14.4A:	Staircase Details
Table No. 14.5	Pressurization of Staircases and Lift Lobbies
Table No. 14.6	Maximum Compartmentation Area of Sprinklered Basement/ Buildings
Table No. 14.7	Minimum Requirements for Fire Fighting Installations
Table No. 14.8	Size of the Mains

## Annexure

Table No. AA-1:	Calorific Values of Common Materials
Table No. AB-1:	Classification of Industries as per Degree of Hazard
Table No. AC-1:	Masonry Walls: Solid (Required to Resist Fire from One Side at a Time)
Table No. AC-2:	Masonry Walls: Hollow (Required to Resist Fire from One Side at a Time)
Table No. AC-3:	Framed Construction, Load Bearing (Required to Resist Fire from One Side at a Time)
Table No. AC-4:	Framed Construction, Non Load Bearing (Required to Resist Fire from One Side at a Time)
Table No. AC-5:	Framed External Walls Load Bearing (Required to Resist Fire from One Side at a Time)
Table No. AC-6:	Framed External Walls Non-Load Bearing [Required to Resist Fire from Inside the Building (A)]
Table No. AC-7:	Framed External Walls Non-Load Bearing [Required to Resist Fire from Inside the Building (B)]
Table No. AC-8:	Framed External Walls Non-Load Bearing [Required to Resist Fire from Inside the Building (C)]
Table No. AC-9:	Reinforced Concrete Columns
Table No. AC-10:	Concrete Beams
Table No. AC-11:	Concrete Floors
Table No. AC-12:	Concrete Floors: Ribbed Open Soffit
Table No. AC-13:	Encased Steel Columns, 203 mm x 203 mm
Table No. AC-14:	Encased Steel Beams, 406 mm x 176 mm (Protection Applied on Three Sides)
Table No. AC-15:	Timber Floors – Tongued and Grooved Boarding, or Sheets of Tongued and Grooved Plywood or Wood Chipboard, of not Less than 21 mm Finished Thickness
Table No. AC-16:	Timber Floors – Tongued and Grooved Boarding, or Sheets of Tongued and Grooved Plywood or Wood Chipboard, of not Less than 15 mm Finished Thickness
Table No. AC-17:	Timber Floors – Any Structurally suitable flooring of Timber or Lignocellulose Boards

## **Figure**

- Figure No. 14.1 Components of Means of Egress
- Figure No. 14.2 Typical Fire Fighting Shaft
- Figure No. 14.3 ( *Deleted* )
- Figure No. 14.4 Sprinklers around Escalator Opening
- Figure No. 14.5 Door Locations at Landing in Fire Exists
- Figure No. 14.6 Minimum Head Room Measurement
- Figure No. 14.7 Dead End Corridor
- Figure No. 14.8 Unacceptable Arrangement for Enclosing a Stair Serving as a Required Exit
- Figure No. 14.9 Minimum Clear Door Width
- Figure No. 14.10 Star Marking and Requirement in Exit
- Figure No. 14.11 Opening Restrictions
- Figure No. 14.12 Typical System of Pumping with One Electric, One Diesel Fire Pump
- Figure No. 14.13 Typical System of Pumping with Two Electric, One Diesel Fire Pump
- Figure No. 14.14 Typical Arrangement of Wet Riser and Total Sprinkler System of Building
- Figure No. 14.15 Part Plan Indicating Concept of Horizontal Exit in Hospital
- Figure No. 14.16 Minimum of Two Exits Accessible from all Parts of Floor

## **Annexure**

- Figure No. AF-1: Sprinkler protection of glass for floor open to Atrium





## 14.1 General

This section, which has been framed in accordance with National Building Code 2016, covers the requirement for fire prevention, life safety in relation to fire and fire protection of buildings. Notwithstanding anything contained anywhere else, this section shall be followed by the fire department and all the authorities required to issue fire and safety permissions. Notwithstanding anything else contained anywhere else in proposed or finalised 'Dadra and Nagar Haveli and Daman & Diu Fire and Emergency Service Regulation, 2022' or in any other such law, these bye-laws shall be deemed to be Bye-Law within the meaning of 2(e) of the draft Dadra and Nagar Haveli and Daman & Diu Fire and Emergency Service Regulation, 2022 and the fire department shall follow the provisions of this part of GDR in supersession of anything contained anywhere else in NBC or any other law. In case there is any confusion regarding any provision in this Part the same may be referred to the Planning and Development Authority whose decision in this regard shall be final. A certificate of the fire department to the effect shall be sufficient proof that all requirements of this chapter have been met.

### 14.1.1 Scope

The provisions are applicable to:

- 1 All multi storeyed buildings (High-rise)
- 2 All of the following:
  - a) Hospitality, education, public offices, mercantile, industrial, storage, hazardous and mixed occupancies, where any of these buildings have floor area more than 500 sq. m on any one or more floors.
  - b) educational buildings having height 9 m and above.
  - c) public offices, health buildings having height 9 m and above.
  - d) all assembly buildings.
  - e) buildings, having area more than 300 sq m of incidental assembly occupancy on any floor; and
  - f) buildings with two basements or more, or with one basement of area more than 500 sq m.

NOTE The owner of the building and parties to agreement, may however, decide to apply the provisions of this rule to buildings other than those given above.

### 14.1.2 Definitions

- 1 *Fire Detection and Alarm System*: A system comprising components and sub-systems required for automatically detecting smoke, heat or fire initiating an alarm and other actions as appropriate. This system also includes manually operated electronic fire alarm (MOEFA<sup>1</sup>) system.
- 2 *Combustible Material*: A material which either burns itself or adds heat to a fire, when tested for non-combustibility in accordance with accepted standard.
- 3 *Down-comer*: An arrangement of firefighting within the building by means of down-comer pipe connected to terrace tank through terrace pump, gate valve and non-return valve and having mains not less than 100 mm internal diameter with landing valves on each floor/landing. It is also fitted with inlet connections at ground level for charging with water by pumping from fire service appliances and air release valve at roof level to release trapped air inside.

---

<sup>1</sup> MOEFA system (with or without automatic fire detection and alarm system) includes all or some of the components such as manual call stations (initiating an alarm for fire and other actions as required), talk-back system and public address system.

- 4 *Dry Riser*: An arrangement of firefighting within the building by means of vertical rising mains not less than 100 mm internal diameter with landing valves on each floor/landing which is normally dry but is capable of being charged with water usually by pumping from fire service appliances.
- 5 *Emergency Lighting*: Lighting provided for use when the supply to the normal lighting fails.
- 6 *Emergency Lighting System*: A complete but discrete emergency lighting installation also fed from the standby power source to the emergency lighting lamp(s), for example, self-contained emergency luminaire or a circuit from central battery (with or without monitoring system) connected through wiring to several escape lighting luminaries.
- 7 *Escape Lighting*: That part of the emergency lighting which is provided to ensure that the escape route is illuminated at all material times, for example, at all times when persons are on the premises, or at times the main lighting is not available, either for the whole building or for the means of egress.
- 8 *Evacuation Lift*: Lift that can be used, during an emergency, for self- evacuation.
- 9 *Exit*: means a passage, channel or means of egress from any building, storey or floor area to a street or other open space of safety. Exit components include exterior exit doors at the level of exit discharge, interior exit stairways, exit passageways, exterior exit stairways and exterior exit ramps.
  - a) *Exit Access*: That portion of a means of egress that leads to an exit (for example, doorways, staircase lobby, ramps, Veranda, corridor, or passageway leading to an exit. (Refer Figure No. 14.1).
  - b) *Exit Access Corridor*: A corridor in exit access which may not necessarily have the requirement of exits being met.
  - c) *Exit Discharge*: The component of a means of egress between the termination of an exit and a public way (Refer Figure. No. 14.1).
  - d) *Horizontal exit*: A defend in place or a staging arrangement, providing safety from fire and smoke originating from the area of incidence, by allowing alternative egress from a compartment to an area of refuge or another compartment at or near the same level. This also includes such egress from a compartment to an adjoining building. A horizontal exit shall be through a fire door of 120 min rating in a fire-resistant wall. Horizontal exits require separation with the refuge area or adjoining compartment through 120 min fire barrier. The adjoining compartment of the horizontal exit should allow unlocked and ease of egress and exits for the occupants using defend in place strategy.
  - d) *Vertical Exit*: means an exit used for ascending or descending between two or more levels, including stairways. smoke-proof towers, ramps, escalators, and fire escapes.

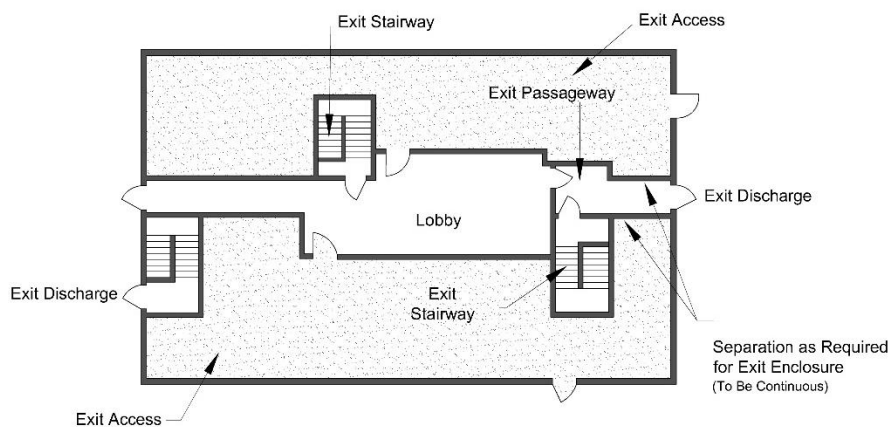

Figure No. 14.1: Components of Exit

- 10 **Fire Barrier (or Fire Resisting Barrier):** A fire barrier is a vertically or horizontally aligned member such as a wall or a fire curtain, or a floor. These may be with discontinuities created by openings with a specified fire resistance rating, where such members are designed and constructed with a specified fire resistance rating to limit the spread of fire that also restricts the movement of smoke.
- 11 **Fire Compartment:** A space within a building that is enclosed by fire barrier or fire-resistant walls on all sides, including the top and bottom.
- 12 **Fire Door / Fire Resistant Door<sup>2</sup>:** Any combination of fire door, frame, hardware, and other accessories that together provide a specific fire-resistant rating to the opening in terms of its stability, integrity, and insulation properties, when installed in the openings in fire separation walls.
- 13 **Fire Exit:** A way out leading from exit access with or without panic bar provided on the door.
- 14 **Firefighting Shaft (Fire Tower):** An enclosed shaft having protected area of 120 min fire resistance rating comprising protected lobby, staircase, and fireman's lift, connected directly to exit discharge or through exit passageway with 120 min fire resistant wall at the level of exit discharge to exit discharge. These shall also serve the purpose of exit requirement/ strategy for the occupants. The respective floors shall be approachable from fire-fighting shaft enabling the fire fighters to access the floor and also enabling the fire fighters to assist in evacuation through fireman's lift. The firefighting shaft shall be equipped with 120 min fire doors. The firefighting shaft shall be equipped with firemen talk back, wet riser and landing valve in its lobby, to fight fire by fire fighters. (see Figure 14.2 for a typical firefighting shaft).

<sup>2</sup> NOTES

- 1 Fire doors in exits shall have fire rating as required in this Part/ these Rules to meet the requirement of integrity and stability; and the insulation criteria shall be 20 min.
- 2 Fire doors in exits shall be provided with intumescent seal.
- 3 Fire doors in exits shall not be allowed to be on hold open position and kept closed and to close by 'door closure — spring mechanism'.
- 4 Fire curtains shall not be allowed as fire exits. If so provided for compartmentation, independent fire door shall be provided meeting the requirement for fire door in exits as above (of the width as required) within the prescribed travel distance requirement.

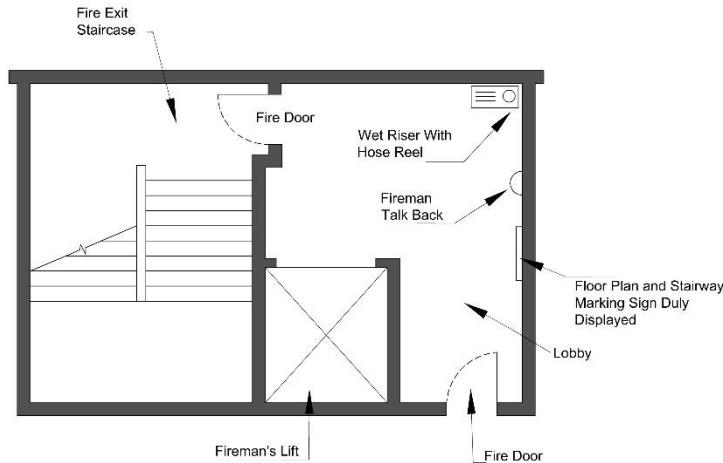

Figure No 14.2: Typical Fire Fighting Shaft

- 15 **Fire Load:** Calorific energy, of the whole contents contained in a space, including the facings of the walls, partitions, floors and ceilings.
- 16 **Fire Load Density:** Fire load divided by floor area.
- 17 **Fire/Fireman's Lift:** A lift or a group of lifts invariably associated with all the features and requirements of a fire-fighting shaft. Such lift(s) are installed to enable fire services personnel to reach different floors with minimum delay and shall meet the additional features as required in accordance with these Rules. This lift also serves the purpose of meeting the requirement of evacuation lift for assisted evacuation.
- 18 **Fire Resistance:** Fire resistance is a property of an element of building construction and is the measure of its ability to satisfy for a stated period, some or all of the following criteria:
  - a) **Load bearing capacity (Stability) (R)** — The ability of a load bearing element to withstand fire exposure without any loss of structural stability.
  - b) **Integrity (E)** — Resistance to penetration of flame and hot gases (minimum 2 hours).
  - c) **Insulation (I)** — Resistance to temperature rise on the unexposed face up to a maximum of 180°C at any single point and average temperature of 140°C.

The fire resistance test of structures shall be done in accordance with IS: 3809-1966 Fire Resistance Test of Structure.

- 19 **Fire Resistance Rating**<sup>3</sup>— The time that a material or construction will withstand the standard fire exposure as determined by fire test done in accordance with the standard methods of fire tests of materials/ structures as per the accepted standard (Refer Annexure K (2)).
- 20 **Fire Resistant Wall:** Fire resistance rated wall, having opening(s) with specified fire-resistant rating, which restricts the spread of fire from one part of a building to another part of the same building.

<sup>3</sup> NOTES

- 1 The requirement of rating of various building elements as given in this Part shall be applicable in accordance with the provisions given in the accepted standard (Refer Annexure K (2))
- 2 The fire resistance rating shall be specified in terms of minutes.
- 3 Fire resistance rating for non-structural material/assembly shall bear a label of compliance to such rating as per the approval of competent authority based on testing and evaluation. The label shall be permanently affixed to the material/assembly and may carry other relevant details such as name and type of the product, and manufacturer's details.

- 21 *Fire Separation*: The distance in metre, measured from the external wall of the building concerned to the external wall of any other building on the site, or from other site, or from the opposite side of street or other public space for the purpose of preventing the spread of fire.
- 22 *Fire Stop*<sup>4</sup>: A fire resistant material, or construction, having a fire resistance rating of not less than the fire separating elements, installed in concealed spaces or between structural elements of a building to prevent the spread/propagation of fire and smoke through walls, ceilings and the like as per the laid down criteria.
- 23 *Fire Suppression Systems*
  - a) *Gas based systems*: Systems that use gaseous agents as fire suppression media, such as, all agents alternate to Halon gases, listed and approved for use by relevant Indian Standards; other methods/types of gas-based systems where their protection is equal to or better than what is suggested above for the type of application subject to the acceptance of Authorities concerned may also fall under such systems.
  - b) *Water based systems*: Systems that use mainly water as firefighting media such as hydrant system, sprinkler system, water spray system, foam system and water mist system.
- 24 *Fire Wall or Fire Separating Wall*: A fire resistance rated wall having fire protected openings, which restricts the spread of fire and extends continuously from the foundation to the roof (and through the roof at least 1m above the roof in case of combustible roof), with sufficient structural stability under fire conditions to allow collapse of construction on one side or either side without collapse of the wall.
- 25 *Fire Exit Hardware*: A door-latching assembly incorporating an actuating member or panic bar that releases the latch bolt upon the application of a force in the direction of egress travel, provided on exits.
- 26 *Lift Lobby*: A space from which people directly enter a lift car(s) and into which people directly enter upon exiting a lift car(s).
- 27 *Means of Egress*: A continuous way of travel from any point in a building or structure to a public way, consisting of three separate and distinct parts, that is, exit access, exit, and exit discharge.
- 28 *Occupant Load*: Maximum number of persons that might occupy a building or portion thereof at any one time.
- 29 *Place of Comparative Safety*: Places within a building where people can stay little longer until evacuation, for example, refuge areas, terrace, fire/ smoke separated compartments, etc.
- 30 *Pressurization*: The establishment of a pressure difference across a barrier to protect exit, stairway, lobby, exit passageway or room of a building from smoke penetration.
- 31 *Pressurization Level*: The pressure difference between the pressurized space and the adjoining area served by the pressurized space expressed in Pascal (Pa).

---

<sup>4</sup> Fire stop assembly for through penetrations is a combination of firestop compatible for use with the penetrant, penetration items such as cables, cable tray, conduits, ducts, pipes, etc, and their means of support through the wall or opening that together restores the fire resistance rating of the fire separating elements in terms of its integrity and/or insulation properties.

Fire stop assembly for joints is the one where fire stop with movement capability is used to seal the linear joints between adjacent fire separating elements, to maintain the fire resistance of the separating elements, which should be installed within its tested design limits with regard to size of the joint, type of assembly, and anticipated compression and extension of the joint.

- 32 *Ramp*: The construction, in the form of an inclined plane that is steeper than or equal to 1: 20 (5 percent) from the horizontal, together with any intermediate landing, that makes it possible to pass from one level to another.
- 33 *Refuge Area*: An area within the building for a temporary use during egress. It generally serves as a staging area which is protected from the effect of fire and smoke.
- 34 *Roof Exits*: A means of escape on to the roof of a building, where the roof has access to it from the ground through alternative staircase or adjacent building.
- 35 *Smoke Barrier*: A continuous membrane, or a membrane, where such membrane is designed and constructed to restrict the movement of smoke.
- 36 *Smoke Compartment*: A space within a building enclosed by smoke barriers on all sides.
- 37 *Stack Pressure*: Pressure difference caused by a temperature difference creating an air movement within a duct, chimney or enclosure.
- 38 *Travel Distance*: The distance to be travelled from any point in a building to a protected exit or external escape route or final exit measured along the line of travel.

*Figure No. 14.3: (Deleted )*

- 39 *Venting Fire*: The process of facilitating heat and smoke to leave a building as quickly as possible by such paths so that lateral spread of fire and heat is checked, firefighting operations are facilitated and minimum fire damage is caused.
- 40 *Visual Strobes/Flashing*: <sup>5</sup>It is an audio-visual fire alarm for alerting persons with hearing impairment with flashing light. The strobe frequency should be from 0.5 Hz to 4.0 Hz.
- 41 *Water Based Systems*
- a) *Hydrant System*: A distribution system having a network of piping installed underground/aboveground around and/or through inside of a building with internal and/or external hydrants fitted with landing valves at regular intervals according to the occupancy. The distribution system is connected to water supply system for firefighting.
  - b) *Automatic Sprinkler System*: A system of water pipes fitted with sprinkler heads at suitable intervals and heights and designed to actuate automatically, control and extinguish a fire by the discharge of water.
  - c) *Automatic Water Spray Systems*: A special fixed pipe system connected to a reliable source of fire protection water supply and equipped with water spray nozzles for specific water discharge and distribution over the surface or area to be protected. The piping system is connected to the water supply through an automatically actuated deluge valve which initiates flow of water. Automatic actuation is achieved by operation of automatic detecting equipment installed along with water spray nozzles. There are two types of systems namely high velocity and medium velocity systems.
  - d) *Water Mist Systems*: A distribution system connected to a pumping and water supply system that is equipped with nozzles capable of delivering water mist to the part/entire enclosure or area, intended to control, suppress, or extinguish fire and is capable of meeting the specified performance requirements.

---

<sup>5</sup> NOTE — Care should be taken to ensure that overlapping strobes do not combine to result in a higher frequency of flashing.

e) *Foam Protection System*: Firefighting systems where foam is made by mechanically mixing air with a solution consisting of fresh water to which a foaming agent (liquid concentrate) has been added. Firefighting foam is a stable aggregation of small bubbles of density lower than oil or water and shows tenacious qualities for covering horizontal surfaces. There are three types of foam applications that is, low, medium and high expansion foams depending upon the application.

42 *Wet Riser*: An arrangement for firefighting within the building by means of vertical rising mains not less than 100 mm nominal diameter with landing valves on each floor/landing for firefighting purposes and permanently charged with water from a pressurized supply.

### **14.1.3 Procedure for Clearance from Fire and Emergency Service for Development Permission and Occupancy Certificate**

- 1 The buildings as mentioned in the 'The Dadra and Nagar Haveli and Daman & Diu Fire and Emergency Service Regulation, 2021' (*Refer Clause 24(1)*) shall obtain 'Fire Safety Certificate' from Fire and Emergency Service.
- 2 Owners of such Buildings, shall ensure that they are equipped with such fire prevention and life safety measures to prevent or extinguish fire, as may be prescribed under these Rules.
- 3 The owner or occupier, as the case may be, shall furnish to the Fire Officer, a certificate in the prescribed form issued by a Fire Protection Consultant on Record (FPCOR) regarding the compliance of the fire prevention and life safety measures in his building or part thereof, as required by or under the provisions of these Rules. This shall be accompanied by plans that clearly mark and indicate the complete fire protection arrangements and the means of access/escape for the proposed building with suitable legend along with standard signs and symbols on the drawings.
- 4 The Fire Officer shall scrutinize the compliances with regard to the requirements made by owners or occupiers or applicant, as the case may be, either independently or jointly, after making necessary inquiry, if any, issue fire safety certificate within a month of the application subject to the condition that all necessary documents, designs, maps, completion certificates etc. shall be submitted by the owner or occupier or applicant.
- 5 If the owner or occupier, as the case may be, fails to comply with the directions issued by the Fire Officer, the fire safety certificate, shall be cancelled after giving owner or occupier an opportunity of hearing to show-cause.
- 6 The owner or occupier of the building or premises, whose fire safety certificate has been cancelled due to default on his part, shall not be entitled to occupy the building or premises on the ground of non-compliance of fire prevention and life safety measures.

### **14.1.4 Renewal of Fire Clearance**

The owner or occupier, as the case may be, shall furnish to the Fire Officer, a certificate in the prescribed form issued by such agency and at such intervals as may be mentioned in applicable Fire and Emergency Service Regulation

### **14.1.5 Fees**

For augmentation of fire service facilities fee payable to Fire Officer by the owner/ occupier along with sets of plans for obtaining the No Objection Certificate shall be as prescribed by the Authority.



#### **14.1.6 Penalties**

Whoever fails without reasonable cause to comply with the necessary fire safety measures shall be punishable with fine which may extend to Ten thousand rupees or with imprisonment for a term which may extend to three months or with both (*Refer Section 35 Dadra and Nagar Haveli and Daman & Diu Fire and Emergency Services Regulation, 2021*).

## **14.2 Fire Prevention**

### **14.2.1 Classification of Buildings based on Occupancy**

- 1 All buildings/uses, whether existing or hereafter erected shall be classified according to use or the character of occupancy in one of the following groups as indicated in the table below. The table also summarizes the types of examples of buildings:

Table No. 14.1: Classification of Buildings based on Occupancy and Fire Divisions

No	Main	Sub	Use Group as per proposed ODP GDR	Detailed Uses As per proposed ODP GDR	Fire Divisions	Occupant Load Factor (sqm/person) As per NBC**	Capacity Factors (Width Per Person in mm) As per NBC		Maximum Travel Distance (Based on Occupancy and Construction Type in m) As per NBC***		Final Remarks
							Stairways	Level Components and Ramps	Types 1 and 2	Types 3 and 4	
(1)	(2)	(3)	(4)	(5)	(6)	(7)	(8)	(9)	(10)	(11)	(12)
1	A	A-1	Dwelling 1	Detached dwelling unit. Clinic not having indoor treatment facility.	Fire Division 1	12.50	10.00	6.50	30.00	22.50	Firefighting installations in Table No. 14.7
			Agriculture 1 (Part)	Farmhouse.							
			Dwelling 1a	Detached dwelling unit – affordable Housing							
			Dwelling 2	Semi-detached dwelling unit Row House Tenement Cottage Industry							
			Dwelling 2a	Semi Detached dwelling unit – affordable Housing							
			Agriculture 1 (Part)	Farmhouse							
2		A-2	Dwelling 3 (Part)	Old Age Home Orphanage		7.5	15	13	30.00	22.50	Firefighting Installation in Table No. 14.7, vary with Height of the Building.
3		A-3	Dwelling 3 (Part) Dormitory	Hostels Dormitories Dharamshala Homestay Night Shelter		12.50	10.00	6.50	30.00	22.50	Firefighting Installation in Table No. 14.7, vary with Height of the Building.
			Dwelling 3 (Part)	Flats Apartment (mixed, serviced)		12.50	10.00	6.50	30.00	22.50	
			Dwelling 3a	Affordable Housing							
			Dwelling 3s	Chawls Labour Housing Sparsh Housing / Affordable Housing Affordable Rental Housing							

No	Main	Sub	Use Group as per proposed ODP GDR	Detailed Uses As per proposed ODP GDR	Fire Divisions	Occupant Load Factor (sqm/person) As per NBC**	Capacity Factors (Width Per Person in mm) As per NBC		Maximum Travel Distance (Based on Occupancy and Construction Type in m) As per NBC***		Final Remarks	
							Stairways	Level Components and Ramps	Types 1 and 2	Types 3 and 4		
(1)	(2)	(3)	(4)	(5)	(6)	(7)	(8)	(9)	(10)	(11)	(12)	
				Complex Low-Cost Housing Complexes								
4	B	B-1	Hospitality 1	Camping Tents Eco Hotels (Upto Four Star Category)	Fire Division 1	12.50	10.00	6.50	30.00	22.50	Firefighting Installation in Table No 14.7, vary with Height of the Building and Floor Area	
			Hospitality 2	Resort Cottage Houses Spa and Wellness Centre (Upto Four Star Category)								
			Hospitality 3	Bed and Breakfast Guest House Lodging and Boarding Hotel Motel Serviced Apartment (Upto Four Star Category)								
5		B-2	Hospitality 1	Camping Tents Eco Hotels (Five Star and above Category)			12.50	10.00	6.50	30.00	22.50	Firefighting Installation in Table No. 14.7, vary with Height of the Building
			Hospitality 2	Resort Cottage Houses Spa and Wellness Centre (Five Star and above Category)								
			Hospitality 3	Bed and Breakfast Guest House Lodging and Boarding Hotel Motel Serviced Apartment (Five Star and above Category)								
6		B-3	Hospitality 3 (Part)	Bed and Breakfast Guest House Lodging and Boarding		12.50	10.00	6.50	30.00	22.50	Firefighting Installation in Table No. 14.7, vary with the number of rooms	

No	Main	Sub	Use Group as per proposed ODP GDR	Detailed Uses As per proposed ODP GDR	Fire Divisions	Occupant Load Factor (sqm/person) As per NBC**	Capacity Factors (Width Per Person in mm) As per NBC		Maximum Travel Distance (Based on Occupancy and Construction Type in m) As per NBC***		Final Remarks
							Stairways	Level Components and Ramps	Types 1 and 2	Types 3 and 4	
(1)	(2)	(3)	(4)	(5)	(6)	(7)	(8)	(9)	(10)	(11)	(12)
				Motel Serviced Apartment (Non-Starred Category)							
7	C	C-1	Education 1	Anganwadi Day Care Pre School Pre-Primary School	Fire Division 1	4	10.00	6.50	30.00	22.50	Firefighting Installation in Table No. 14.7, vary with Height of the Building
			Education 2	Primary Schools Secondary Schools Higher Secondary Schools							
			Education 3	Polytechnic Industrial Training Institutes (ITI) Vocational Training Centre College University and Ancillary use							
8		C-2	Education 3	Research and Development Establishments/ Centre	Fire Division 2	10	10.00	6.50	30.00	30.00	
9	D	D-1	Health 1	PHC, Clinic without indoor facility Dispensary Health and Wellness Centre Ayushman Bharat	Fire Division 1	10 (Outdoor Patients area)	15	13	30.00	22.50	Firefighting Installation in Table No. 14.7, vary with Height of the Building, area of Building Unit and No. of Beds
			Health 2	Clinic with indoor facility Indoor Hospital facility up to 20 Bed Surgical Hospital, Nursing Home, Maternity Home, Community Health Centre Veterinary Facilities							

No	Main	Sub	Use Group as per proposed ODP GDR	Detailed Uses As per proposed ODP GDR	Fire Divisions	Occupant Load Factor (sqm/person) As per NBC**	Capacity Factors (Width Per Person in mm) As per NBC		Maximum Travel Distance (Based on Occupancy and Construction Type in m) As per NBC***		Final Remarks
							Stairways	Level Components and Ramps	Types 1 and 2	Types 3 and 4	
(1)	(2)	(3)	(4)	(5)	(6)	(7)	(8)	(9)	(10)	(11)	(12)
10			Health 3	Multi-specialty hospital- Upto 100 beds Medical College, Research and Development Centre Hospital- more than 100 beds		15 (see Note 2)	15	13	30.00	22.50	Firefighting Installation in Table No. 14.7, vary with Height of the Building and number of persons
			Health 4	Hospital for infectious diseases Mental Hospital / Asylum							
			Public / Public Office	Custodial and Penal institutions Jails Prison Mental hospitals Houses of Correction Detention Reformatories							
11		D-3	Public / Public Office	Offices for public Government / semi government entities for Health Transport Communication Security Ward Office Law Courts, Police Stations / Chowkis Panchayat Circuit House etc.		10	10	6.5	30.00	30.00	Firefighting Installation in Table No. 14.7, vary with Height of the Building
12	E	E-1	Assembly 1	Community Hall Banquet Hall (No permanent seating and no permanent stage)	Fire Division 1	0.65	10	6.5	30.00	30.00	Firefighting Installation in Table No. 14.7, vary with Height of the Building and number of persons
			Assembly 2	Town Hall Convention Centre Exhibition Hall Studio							

No	Main	Sub	Use Group as per proposed ODP GDR	Detailed Uses As per proposed ODP GDR	Fire Divisions	Occupant Load Factor (sqm/person) As per NBC**	Capacity Factors (Width Per Person in mm) As per NBC		Maximum Travel Distance (Based on Occupancy and Construction Type in m) As per NBC***		Final Remarks
							Stairways	Level Components and Ramps	Types 1 and 2	Types 3 and 4	
(1)	(2)	(3)	(4)	(5)	(6)	(7)	(8)	(9)	(10)	(11)	(12)
				Performing Arts Theatre Gymnasium (without spectator seating) Club (No permanent seating and no permanent stage)							
			Assembly 4	Party Plot (No permanent seating and no permanent stage)							
13		E-2	Assembly 2	Convention Centre Auditorium Planetarium Museum Performing Arts Theatre (with Fixed seatings)		N *1.2 (where N = number of seats)  (see Note 4)	10	6.5	30.00	30.00	Firefighting Installation in Table No. 14.7, vary with Height of the Building and number of persons.
			Assembly 3	Theatre Cinema Multiplex (with Fixed seatings)							
14		E-3	Religious	Temple Shrine Church / Chapel Mosque / Dargah Gurudwara Synagogue Ashram / Upashraya / Math / Sant Niwas Any other Religious Structure. ( No permanent seating and no permanent stage)	Fire Division 1	0.65	10	6.5	30.00	30.00	Firefighting Installation in Table No. 14.7, vary with Height of the Building and number of persons

No	Main	Sub	Use Group as per proposed ODP GDR	Detailed Uses As per proposed ODP GDR	Fire Divisions	Occupant Load Factor (sqm/person) As per NBC**	Capacity Factors (Width Per Person in mm) As per NBC		Maximum Travel Distance (Based on Occupancy and Construction Type in m) As per NBC***		Final Remarks
							Stairways	Level Components and Ramps	Types 1 and 2	Types 3 and 4	
(1)	(2)	(3)	(4)	(5)	(6)	(7)	(8)	(9)	(10)	(11)	(12)
15		E-4	Sports and Leisure	Gymnasium Sports complex Swimming pool Playfield Water sports facilities Theme Amusement Park Aquarium Exhibition Mela Shooting Range	Fire Division 1	1.4 (see Note 3)	10	6.5	30.00	30.00	Firefighting Installation in Table No. 14.7, vary with Height of the Building and number of persons.
			Cremation and Burial	Crematorium							
			Temporary Use	Fair Circus Exhibition Mela Pandal Concrete batching plant for construction Seasonal Market							
16	F	F-1	Transportation	Bus Terminal / station (public / private) Transport Terminal for Passengers	Fire Division 1	30	10	6.5	30.00	30.00	Firefighting Installation in Table No. 14.7, vary with Height of the Building and number of persons
			EP 2	Port Harbour Hover ports for Coast Guards Jetties							
17		F-2	Transportation	Transport Terminal for Goods (Truck)	Fire Division 3	30	10	6.5	30 (see Note 8)	NA	Firefighting Installation in Table No. 14.7, vary with Height of the Building and Covered area



No	Main	Sub	Use Group as per proposed ODP GDR	Detailed Uses As per proposed ODP GDR	Fire Divisions	Occupant Load Factor (sqm/person) As per NBC**	Capacity Factors (Width Per Person in mm) As per NBC		Maximum Travel Distance (Based on Occupancy and Construction Type in m) As per NBC***		Final Remarks
							Stairways	Level Components and Ramps	Types 1 and 2	Types 3 and 4	
(1)	(2)	(3)	(4)	(5)	(6)	(7)	(8)	(9)	(10)	(11)	(12)
18	G	G-1	Agriculture 1 (Part)	Green Houses Dairy Development Animal rearing and breeding/gaushala Poultry Farm	Fire Division 2	1.4	10	6.5	45 (see Note 8)	NA	Firefighting Installation in Table No. 14.7, vary with Height of the Building and Covered area
19		G-2	Agriculture 2 Storage	Animal Shed Agro-Based Storage Warehouse Godown Cold storage Steel stockyard Ice Factory	Fire Division 3	30	10	6.5	30 (see Note 8)	NA	Firefighting Installation in Table No. 14.7, vary with Height of the Building and Covered area
20	H	H-1	Mercantile 1	Office	Fire Division 1	10	10	6.5	30.00	30.00	Firefighting Installation in Table No. 14.7, vary with Height of the Building and Area
			Mercantile 2	Business Offices Corporate Offices							
21		H-2	Mercantile 2	Shopping mall Shopping complex Cineplex			1.8	10	6.5	30.00	30.00
22		H-3	Mercantile 1	Retail shop Shopping Centre Office Restaurant Café		6	10	6.5	30.00	30.00	Firefighting Installation in Table No. 14.7, vary with Height of the Building and Area
23		H-4	Mercantile 2	Vegetable Fish Market Agriculture Horticulture Produce	Fire Division 1	3	10	6.5	30.00	30.00	Firefighting Installation in Table No. 14.7, vary with Height of the Building and Area
			Mercantile 3	Wholesale Market and ancillary uses Timber mart / Lathi Bazaar							

No	Main	Sub	Use Group as per proposed ODP GDR	Detailed Uses As per proposed ODP GDR	Fire Divisions	Occupant Load Factor (sqm/person) As per NBC**	Capacity Factors (Width Per Person in mm) As per NBC		Maximum Travel Distance (Based on Occupancy and Construction Type in m) As per NBC***		Final Remarks
							Stairways	Level Components and Ramps	Types 1 and 2	Types 3 and 4	
(1)	(2)	(3)	(4)	(5)	(6)	(7)	(8)	(9)	(10)	(11)	(12)
24	I	I	Mercantile 2	Laboratory Research establishments	Fire Division 2	10	10	6.5	30.00	30.00	Firefighting Installation in Table No. 14.7, vary with Height of the Building
			Assembly 2	Library							
			Service Establishment 2	Call Centres Service-related shops Information Technology (IT) Biotechnology (BT) Nano Technology (NT)							
			Utility	Communication Infrastructure – telephone, microwave tower or other means of communication facilities							
25	J	J-1*	Utility	Infrastructure for Water Supply – treatment / purification plant, pumping station.	Fire Division 2	10	10	6.5	45 (see Note 8)	NA	Firefighting Installation in Table No 14.7, vary with Height of the Building and Covered area
			Industrial 1	All White Category of Industries as defined by CPCB in Classification of Industrial Sector (2016)							
			Industrial 2	All Green Category of Industries as defined by CPCB in Classification of Industrial Sector (2016), CETP							
			Industrial 3	All Orange Category of Industries as defined by CPCB in Classification of Industrial Sector (2016), CETP Dumping of Solid Waste Mining and Quarrying Brick Kiln Roof Tiles Tannery Slaughterhouse							

No	Main	Sub	Use Group as per proposed ODP GDR	Detailed Uses As per proposed ODP GDR	Fire Divisions	Occupant Load Factor (sqm/person) As per NBC**	Capacity Factors (Width Per Person in mm) As per NBC		Maximum Travel Distance (Based on Occupancy and Construction Type in m) As per NBC***		Final Remarks
							Stairways	Level Components and Ramps	Types 1 and 2	Types 3 and 4	
(1)	(2)	(3)	(4)	(5)	(6)	(7)	(8)	(9)	(10)	(11)	(12)
				Petroleum Storage Roofing Tiles and Cement Pipes							
26		J-2*	Service Establishment 1	Wood Workshop Service Garage Flour mills Laundry / dry cleaning establishment	Fire Division 2	10	10	6.5	45 (see Note 8)	NA	Firefighting Installation in Table No. 14.7, vary with Height of the Building and Covered area
		Utility	Electric substations								
		Industrial 1	All White Category of Industries as defined by CPCB in Classification of Industrial Sector (2016)								
		Industrial 2	All Green Category of Industries as defined by CPCB in Classification of Industrial Sector (2016), CETP								
			Industrial 3	All Orange Category of Industries as defined by CPCB in Classification of Industrial Sector (2016), CETP Dumping of Solid Waste Mining and Quarrying Brick Kiln Roof Tiles Tannery Slaughterhouse Petroleum Storage Roofing Tiles and Cement Pipes							
27		J-3*	Industrial 1	All White Category of Industries as defined by CPCB in Classification of Industrial Sector (2016)	Fire Division 3	10	10	6.5	22.5 (see Note 8)	NA	Fire fighting Installation in Table No. 14.7, vary with Covered Area
			Industrial 2	All Green Category of Industries as defined by CPCB in							

No	Main	Sub	Use Group as per proposed ODP GDR	Detailed Uses As per proposed ODP GDR	Fire Divisions	Occupant Load Factor (sqm/person) As per NBC**	Capacity Factors (Width Per Person in mm) As per NBC		Maximum Travel Distance (Based on Occupancy and Construction Type in m) As per NBC***		Final Remarks
							Stairways	Level Components and Ramps	Types 1 and 2	Types 3 and 4	
(1)	(2)	(3)	(4)	(5)	(6)	(7)	(8)	(9)	(10)	(11)	(12)
			Industrial 3	Classification of Industrial Sector (2016), CETP All Orange Category of Industries as defined by CPCB in Classification of Industrial Sector (2016), CETP Dumping of Solid Waste Mining and Quarrying Brick Kiln Roof Tiles Tannery Slaughterhouse Petroleum Storage Roofing Tiles and Cement Pipes							

Notes:

\*Detailed uses of Subgroup J-1, J-2 and J-3 will correspond to low hazard, moderate hazard and high hazard respectively as in accordance with Annex B

\*\* Occupant load

- 1 Gross area shall be the floor area. All factors expressed are in gross area unless marked net.
- 2 Occupant load in dormitory portions of homes for the aged, orphanages, insane asylums, etc where sleeping accommodation is provided shall be calculated at not less than 7.5 m<sup>2</sup> gross floor area / person.
- 3 These shall include gymnasium, table tennis room, billiard room and other gaming rooms, library, swimming pool and like.
- 4 In case of assembly occupancy having fixed seats, the occupant load shall be determined by multiplying the number of seats by 1.2.
- 5 Car parking areas under occupancy other than storage shall also be 30 m<sup>2</sup> per person.

\*\*\* Travel Distance

- 6 For fully sprinklered building, the travel distance may be increased by 50 percent of the values specified.
- 7 Ramp shall not be counted as an exit in case of basements below first basement in car parking.
- 8 Construction of Type 3 or Type 4 is not permitted.

## 14.2.2 Fire Divisions

- 1 The above occupancies are grouped in fire divisions, also indicated in the Table No. 14.2. The fire divisions are broadly designated as follows:
- Fire Division No. 1: This division shall comprise all the sub-groups and detailed uses falling under low hazard uses as per these Rules.
  - Fire Division No. 2: This division shall comprise all the sub-groups and detailed uses falling under moderate hazard uses as per these Rules.
  - Fire Division No. 3: This division shall comprise all the sub-groups and detailed uses falling under high hazard uses as per these Rules.

Table No.14.2: Fire Divisions

No	Fire Division	Sub Category	Use Group as per proposed ODP GDR
(1)	(2)	(3)	(4)
1	Fire Division 1	A-1	Dwelling 1
			Agriculture 1 (Part)
			Dwelling 1a
			Dwelling 2
			Dwelling 2a
		A-2	Dwelling 3 (Part)
		A-3	Dwelling 3 (Part)
			Dormitory
			Dwelling 3 (Part)
			Dwelling 3a
			Dwelling 3s
		B-1	Hospitality 1
			Hospitality 2
			Hospitality 3
		B-2	Hospitality 1
			Hospitality 2
			Hospitality 3
		B-3	Hospitality 3 (Part)
		C-1	Education 1
			Education 2
			Education 3
		D-1	Health 1
			Health 2
			Health 3
		D-2	Health 4
			Public / Public Office
		D-3	Public / Public Office
		E-1	Assembly 1
			Assembly 2
			Assembly 4
		E-2	Assembly 2
			Assembly 3
		E-3	Religious
E-4	Sports and Leisure		
	Cremation and Burial		
	Temporary Use		
F-1	Transportation		
	EP 2		
H-1	Mercantile 1		
	Mercantile 2		
H-2	Mercantile 2		
H-3	Mercantile 1		

No	Fire Division	Sub Category	Use Group as per proposed ODP GDR		
(1)	(2)	(3)	(4)		
		H-4	Mercantile 2 Mercantile 3		
2	Fire Division 2	I	Mercantile 2 Assembly 2 Service Establishment 2 Utility		
			J-1	Utility Industrial 1 Industrial 2 Industrial 3	
				J-2	Service Establishment 1 Utility Industrial 1 Industrial 2 Industrial 3
					G-1
		C-2	Education 3		
		3	Fire Division 3	F-2	Transportation
				G-2	Agriculture 2 Storage
					J-3

2 Temporary Buildings or Structures

- a) Temporary buildings and structures shall be put under Fire Division No. 1 as the case may be, according to the purpose for which these are to be used, by special permit from the Authority for a limited period and subject to such conditions as may be imposed in the permit.
- b) Such buildings and temporary structures shall be completely removed on the expiry of the period specified in the permit.
- c) Adequate fire precautionary measures in the construction of temporary structures and Pandals shall be taken in accordance with good practice (*Refer Annexure K (10)*).

3 Restriction on the type of construction for new buildings

These shall be as follows:

- a) Buildings erected in Fire Division No. 1 shall conform to construction of Type 1, 2, 3 or 4.
- b) Buildings erected in Fire Division No. 2 shall conform to construction of Type 1, 2 or 3.
- c) Buildings erected in Fire Division No. 3 shall conform to construction of Type 1 or 2.

4 Restrictions on Existing Buildings

The existing buildings in any fire divisions not be required to comply with the requirements of these Rules unless these are altered, or in the opinion of the Authority, such building constitutes a hazard to the safety of the adjacent property or to the occupants of the building itself or is an unsafe building.

In the event of alteration, it shall be necessary to obtain permission of the Authority for such alteration consistent with fire hazard. Alterations/modifications/renovations shall be accomplished so as to ensure conformity with all the safety requirements of the new buildings. Such alterations shall not in any way bring down level of fire and life safety below that which existed earlier. Any addition or alterations or construction of cubicles or partitioning, for floor area exceeding 500 m<sup>2</sup> for all high-rise buildings shall be with the approval of local fire authority.

### 14.2.3 Types of Building Construction

- 1 The design of any building and the type of materials used in its construction are important factors in making the building resistant to a complete burn-out and in preventing the rapid spread of fire, smoke or fumes, which may otherwise contribute to the loss of lives and property.

The fire resistance of a building or its structural and non-structural elements is expressed in minutes against a specified fire load which is expressed in kcal/m<sup>2</sup>, and against a certain intensity of fire. The fire-resistance test for structural element shall be done in accordance with accepted standards.

Types of construction according to fire resistance shall be classified into four categories:

- a) Type 1 Construction,
- b) Type 2 Construction,
- c) Type 3 Construction
- d) Type 4 Construction.

The minimum fire resistance ratings of structural and non-structural members for various types of construction shall be as given in Table No. 14.3. Non-combustible materials should be used for construction of buildings, and the internal walls of staircase enclosures should be of brick work or reinforced concrete or any other material of construction with minimum of 120 min rating. The walls for the chimney shall be of Type 1 or Type 2 Construction depending on whether the flue gas temperature is above 200°C or less, respectively. Load bearing steel beams and columns of buildings having total covered area of 500 m<sup>2</sup> and above shall be protected against failure/collapse of structure in case of fire.

- 2 It is required that a structural and/or non-structural element/component shall have the requisite fire resistance rating (*Refer Table No. 14.3*). The fire resistance rating for the structural and non-structural elements shall be based on guidelines as per approved and accepted standards. The fire rating shall be validated and certified with a view to meeting the requirements of Table No. 14.3. In the absence of any validated/certified rating, guidance may be obtained from the information available in Annexure C.
- 3 Load bearing steel beams and columns of buildings having total covered area of 500 m<sup>2</sup> and above shall be protected against failure/collapse of structure in case of fire. This could be achieved by use of appropriate methodology using suitable fire resistance rated materials along with suppression system (*Refer Annexure C, Table 25 and Table 26 Timber Floors*).
- 4 The false ceiling, including all fixtures used for its suspension, shall be of non-combustible material and shall provide adequate fire resistance to the ceiling in order to prevent spread of fire across ceiling.

Table No.14.3: Fire Resistance Ratings of Structural and Non-Structural Elements (minutes)

No.	Structural Element	Fire Resistance Ratings (min) for Type of Construction			
		Type 1	Type 2	Type 3	Type 4
(1)	(2)	(3)	(4)	(5)	(6)
i)	Exterior walls:				
	a) Fire less than 3.7 m:				
	1) Bearing	240	120	120	60
	2) Non-bearing	120	90	60	60
	b) Fire separation of 3.7 m or more but less than 9 m				
	1) Bearing	240	120	120	60
	2) Non-bearing separation	90	60	60	60
	c) Fire separation of 9 m or more:				
	1) Bearing	240	120	120	60
	2) Non-bearing	60	60	60	60
ii)	Fire separation assemblies (like fire check doors)	120	120	120	120
iii)	Fire enclosures of exits	120	120	120	120
iv)	Shafts for services, lift hoist way and refuse chutes	120	120	120	120
v)	Vertical separation between adjacent tenant spaces	60	60	60	60
vi)	Dwelling unit separation:				
	a) Load bearing	120	120	60	60
	b) Non-load bearing	60	60	30	30
vii)	Interior bearing walls, bearing partitions, columns, beams, girders, trusses (other than roof trusses) and framing:				
	a) Supporting more than one floor	240	120	120	120
	b) Supporting one floor only	180	90	60	60
	c) Supporting a roof only	180	90	60	60
viii)	Walls supporting structural members	180	90	60	60
ix)	Floor construction	120	90	60	60
x)	Roof construction:				
	a) 5 m or less in height to lowest member	120	90	60	60
	b) More than 5 m but less than 6.7 m in height to lowest member	60	60	60	60
	c) 6.7 m or more in height to lowest member	0	0	0	0
NOTES:					
1 The above fire resistance rating shall be required to achieve the respective type of construction unless otherwise specified in the respective clauses for different applications/use.					
2 In case of lift bank, the partition wall, if any, need not be of fire rating specified in this table.					

#### 14.2.4 General Requirements of All individual Occupancies

##### 1 General

All buildings shall satisfy certain requirements, which contribute, individually and collectively, to the safety of life from fire, smoke, fumes and panic arising from these or similar causes. There are, however, certain general principles and common requirements, which are applicable to all or most of the occupancies.

##### 2 Exceptions and Deviations

Exceptions and deviations to the general provisions of requirements of individual occupancies are given as applicable to each type of occupancy in Rule No. 14.5. In case of practical difficulty or to avoid unnecessary hardship, without sacrificing reasonable safety, local head, fire services may consider exemptions from the Rules.



### 3 Occupation of Buildings under Construction

- a) A building or portion of the building may be occupied during construction, repairs, alterations, or additions only if all means of exit and fire protection measures are in place and continuously maintained for the occupied part of the building.
- b) A high rise building during construction shall be provided with the following fire protection measures, which shall be maintained in good working condition at all the times:
  - i) Dry riser of minimum 100 mm diameter pipe with hydrant outlets on the floors constructed with a fire service inlet to boost the water in the dry riser and maintenance should be in accordance with good practice (*Refer Annexure K (12)*).
  - ii) Drums of 2000 litre capacity filled with water with two fire buckets on each floor;
  - iii) A water storage tank of minimum 20000 litre capacity, which may be used for other construction purposes also.

### 4 Openings in Fire Resistant Walls and Floors

- a) At the time of designing openings in fire resistant walls and floors, particular attention shall be paid to all factors which limit fire spread through these openings and maintain fire rating of the structural members.
- b) For Types 1 to 3 constructions, a doorway or opening in a fire-resistant wall on any floor shall be limited to 5.6 sq m in area with a maximum height/width of 2.75 m. Every wall opening shall be protected with fire-resisting doors, having the fire rating of not less than 120 min. The openings in the floors shall be protected by vertical enclosures extending above and below such openings, such enclosures having a fire resistance of not less than 120 min and all openings therein being protected with a fire-resisting assembly as per Rule No.14.2.4 (4(f)).

For escalator openings, the smoke spill shall be avoided by provision of smoke barrier (of 450-600 mm) thereby creating smoke compartment. Further, the protection shall be ensured through installation of sprinklers on all sides of the cut out opening on each floor (*Refer Figure No. 14.4*).

- c) For Type 4 construction, openings in the fire separating walls or floors shall be fitted with 120 min fire-resistance rated assemblies.
- d) Service ducts and shafts

Openings in walls or floors which are necessary to be provided to allow passages of all building services like cables, electrical wirings, telephone cables, plumbing pipes, etc, shall be protected by enclosure in the form of ducts/shafts having a fire resistance not less than 120 min. The inspection door for electrical shafts/ducts shall be not less than 120 min. Further, medium and low voltage wiring running in shafts/ducts, shall either be armoured type or run through metal conduits.

The space between the electrical cables/conduits and the walls/slabs shall be filled in by a fire stop material having fire resistance rating of not less than 120 min. This shall exclude requirement of fire stop sealing for low voltage services shaft.

For plumbing shafts in the core of the building<sup>6</sup>, with shaft door opening inside the building, the shafts shall have inspection doors having fire resistance rating not less than 30 min.

For plumbing shafts doors which open in wet areas or in naturally ventilated areas or on external wall of the building, the shafts may not require doors having any specified fire rating.

---

<sup>6</sup> NOTE : In the case of buildings where it is necessary to lower or lift heavy machinery or goods from one floor to the other, it may be necessary to provide larger openings in the floor. Such openings shall be provided with removable covers which shall have the same strength and fire resistance as the floor.

e) Refuse chutes

Refuse chutes, if any provided in a building, shall have opening at least 1 m above roof level for venting purpose and they shall have an enclosure wall of non-combustible material with fire resistance of not less than 120 min.

They shall not be located within the staircase enclosure or service shafts, or air conditioning shafts. Refuse chutes inspection panel and doors shall be tight fitting with 60 min fire resistance. Sprinkler protection system shall be provided for the refuse chutes. They shall be at least 6 m away from exits.

f) Vertical Opening

Every vertical opening between the floors of a building shall be suitably enclosed or protected, as necessary, to provide the following:

- i) Reasonable safety to the occupants while using the means of egress by preventing spread of fire, smoke, or fumes through vertical openings from floor to floor to allow occupants to complete their use of the means of egress. Further it shall be ensured to provide a clear height of 2100 mm in the exit access.
- ii) Limitation of damage to the building and its contents.

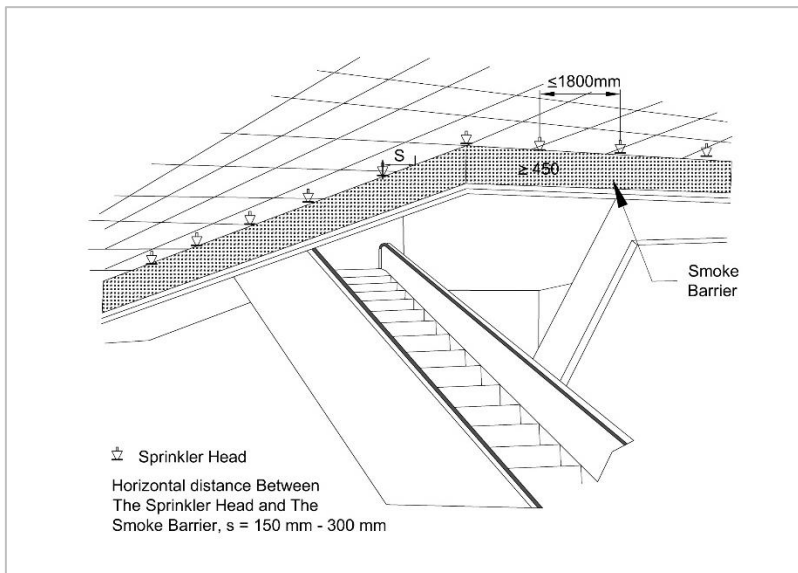

Figure No. 14.4: Sprinklers around Escalator Opening

## 5 Electrical Installation

a) General Requirements

For requirements regarding electrical installations from the point of view of fire safety, reference may be made with the provisions of Part VIII Building Services, Section II Electrical and Allied Installations, National Building Code and Annexure K(6), to the satisfaction of the Competent Authority.

In general, it is desirable that wiring and cable must have flame retardant property. Medium and low voltage wiring running in shafts, and within false ceiling shall run in metal conduit. Any 230 V wiring for lighting or other services, above false ceiling, shall have 660 V grade insulation.

The electric distribution cables/wiring shall be laid in a separate shaft. The shaft shall be sealed at every floor with fire stop materials having the same fire resistance as that of the floor. High, medium and low voltage wiring running in shaft and in false ceiling shall run in separate shaft/conduits.

Water mains, gas pipes, telephone lines, intercom lines or any other service line shall not be laid in the duct for electrical cables; use of bus ducts/solid rising mains instead of cables is preferred.

All metallic items like steel structural members, etc, shall be bonded properly to the earthing system.

b) Emergency Power for Fire and Life Safety Systems

Emergency power supplying distribution system for critical requirement for functioning of fire and life safety system and equipment shall be planned for efficient and reliable power and control supply to the following systems and equipment where provided:

- i) Fire pumps.
- ii) Pressurization and smoke venting; including its ancillary systems such as dampers and actuators.
- iii) Fireman's lifts (including all lifts).
- iv) Exit signage lighting.
- v) Emergency lighting.
- vi) Fire alarm system.
- vii) Public address (PA) system (relating to emergency voice evacuation and annunciation).
- viii) Magnetic doors hold open devices.
- ix) Lighting in fire command centre and security room.

Power supply to these systems and equipment shall be from normal and emergency (standby generator) power sources with changeover facility. If power supply, is from HV source and HV generation, the transformer should be planned in standby capacity to ensure continuity of power to such systems. Wherever transformers are installed at higher levels in buildings and backup DG sets are of higher voltage rating, then dual redundant cables shall be taken to all transformers. The generator shall be capable of taking starting current of all the fire and life safety systems and equipment as above.

Where parallel HV/LV supply from a separate substation fed from different grid is provided with appropriate transformer for emergency, the provision of generator may be waived in consultation with the Authority.

The power supply to the panel/distribution board of these fire and life safety systems shall be through fireproof enclosures or circuit integrity cables or through alternate route in the adjoining fire compartment to ensure supply of power is reliable to these systems and equipment. It shall be ensured that the cabling from the adjoining fire compartment is protected within the compartment of vulnerability. The location of the panel/ distribution board feeding the fire and life safety system shall be in fire safe zone ensuring supply of power to these systems.

Circuits of such emergency system shall be protected at origin by an automatic circuit breaker with its no-volt coil removed. Master switches controlling essential service circuits shall be clearly labelled. Cables for fire alarm and PA system shall be laid in metal conduits or armoured to provide physical segregation from the power cables.

c) Substation/Transformers

Areas in substation shall not be used as storage/dump areas or for other utility purposes other than those required for the functioning of the substation. The substation area should be adequately ventilated.

An independent, ventilated or air conditioned MV panel room shall be provided on the ground level or first basement. This room shall be provided with access from outside (or

through exit passageway accessible from outside). The MV panel room shall be provided with fire resistant walls and doors of fire resistance of not less than 120 min.

If the licensees agree to provide meters on upper floors, the licensees cables shall be segregated from consumers cables by providing a partition in the shaft. Meter rooms on upper floors shall not open into staircase enclosures and should be ventilated directly to open air outside or in electrical room of 120 min fire resistant walls.

Electrical MV main distribution panel and lift panels shall be provided with CO2/inert gas flooding system for all panel compartments with a cylinder located beside the panel.

i) Oil Filled Substation

A substation or a switch-station with oil filled equipment shall be limited to be installed in utility building or in outdoor location. Such substation/utility building shall be at least 7 m away from the adjoining building(s).

Substation equipment (exceeding oil capacity of 2000 litre) in utility building shall have fire rated baffle walls of 240 min rating constructed between such equipment, raised to at least 600 mm above the height of the equipment (including height of oil conservators) and exceeding 300 mm on each side of the equipment.

All transformers where capacity exceeds 10 MVA shall be protected by high velocity water spray systems or nitrogen injection system.

ii) Dry Type Substation

Transformers located inside a building shall be of dry type and all substation/switch room walls, ceiling, floor, opening including doors shall have a fire resistance rating of 120 min. Access to the substation shall be provided from the nearest fire exit/exit staircase for the purpose of electrical isolation.

d) Standby Supply

Diesel generator set(s) shall not be installed at any floor other than ground/first basement. If the same are installed indoors, proper ventilation and exhaust shall be planned. The DG set room shall be separated by 120 min fire resistance rated walls and doors.

The oil tank for the DG sets (if not in the base of the DG) shall be provided with a dyked enclosure having a volumetric capacity of at least 10 percent more than the volume of the oil tank. The enclosure shall be filled with sand for a height of 300 mm.

For detailed information regarding fire safety requirements for hazardous petroleum products, reference may be made to the Petroleum Act, 1934 and the Rules, framed thereunder.

e) Lightning Protection of Buildings

Routing of down conductors (insulated or uninsulated) of lightning protection through electrical or other service shafts are not allowed as it can create fire and explosion during lightning (Refer Part VIII Building Services, Section II Electrical and Allied Installations, National Building Code).

6 Escape Lighting and Exit Signage:

Exit access, exits, and exit discharge shall be properly identified, with adequate lighting maintained in the elements of the egress systems so that all occupants shall be able to leave the facility safely.

a) Lighting

i) The exit, exit access and exit discharge systems shall be illuminated continuously. The floors of the means of egress shall be illuminated at all points, including angles and intersections, in corridors and passageways, stairwells, landings of stairwells and exit.

- ii) Emergency lighting shall be powered from a source independent of that supplying the normal lighting.
  - iii) Escape lighting shall be capable of,
    - indicating clearly and unambiguously the escape routes.
    - providing adequate illumination along such routes to allow safe movement of persons towards and through the exits; and
    - ensuring that fire alarm call points and firefighting equipment provided along the escape routes can be readily located.
  - iv) The horizontal luminance at floor level on the centreline of an escape route shall not be less than 10 lumen/m<sup>2</sup>. In addition, for escape routes up to 2 m wide, 50 percent of the route width shall be lit to a minimum of 5 lumen/m<sup>2</sup>. In auditoriums, theatres, concert halls and such other places of assembly, the illumination of floor exit/access may be reduced during period of performances to values not less than 2 lux.
  - v) Required illumination shall be arranged such that the failure of any single lighting unit, such as the burning out of one luminaire, will not leave any area in darkness and does not impede the functioning of the system further.
  - vi) The emergency lighting shall be provided to be put on within 5s of the failure of the normal lighting supply. Also, emergency lighting shall be able to maintain the required illumination level for a period of not less than 90 min in the event of failure of the normal lighting even for smaller premises.
  - vii) Battery pack emergency lighting, because of its limited duration and reliability, shall not be allowed to be used in lieu of a diesel engine driven emergency power supply.
  - viii) Escape lighting luminaires should be sited to cover the following locations:
    - Near each intersection of corridors,
    - At exits and at each exit door,
    - Near each change of direction in the escape route,
    - Near each staircase so that each flight of stairs receives direct light,
    - Near any other change of floor level,
    - Outside each final exit and close to it,
    - Near each fire alarm call point,
    - Near firefighting equipment, and
    - To illuminate exit and safety signs as required by the enforcing authority.
  - ix) The luminaires shall be mounted as low as possible, but at least 2 m above the floor level.
  - x) Signs are required at all exits, emergency exits and escape routes, which should comply with the graphic requirements of the relevant Indian Standards.
- b) Exit passageway (at ground) and staircase lighting shall also be connected to alternative supply. The alternative source of supply may be provided by battery continuously trickle charged from the electric mains.
- c) Suitable arrangements shall be made by installing double throw switches to ensure that the lighting installed in the staircase and the corridor does not get connected to two sources of supply simultaneously. Double throw switch shall be installed in the service room for terminating the stand-by supply.  
The emergency lighting system shall be well maintained by periodical inspections and tests so as to ensure their perfect serviceability at all times.
- d) Exit Signage  
Where exit access is provided through corridors/paths, the occupants shall be able to easily identify the way to exits. Exit signs shall be provided such that no point in an exit access is more than 30 m from a visible exit directional sign. An exit sign indicating the direction to an exit shall be provided at all changes in direction.  
Exits shall be clearly visible and the route to reach the exits shall be clearly marked and signs posted to guide the occupants of the floor concerned. Signs shall be illuminated and

wired to an independent electrical circuit on an alternative source of supply. The sizes and colours of the exit signs shall be in accordance with good practice (*Refer Annexure K(7)*). The colour of the exit signs shall be green.<sup>7</sup>

The exit sign with arrow indicating the way to the escape route shall be provided at a suitable height from the floor level on the wall and shall be illuminated by electric light connected to corridor circuits. All exit way marking signs should be so installed that no mechanical damage shall occur to them due to moving of furniture or other heavy equipment. Further, all landings of floor shall have floor indicating boards prominently indicating the number of the floor. Photo luminescent markings shall be pasted at internal hydrant boxes.

## 7 Air Conditioning, Ventilation and Smoke Control

- a) Air conditioning and mechanical ventilation requirements of different rooms or areas in any occupancy shall be in accordance with Part VIII 'Building Services Section I Lighting and Natural Ventilation and 'Section III Air conditioning, Heating and Mechanical Ventilation' National Building Code.

Air conditioning and ventilating systems shall be so installed and maintained as to minimise the danger of spread of fire, smoke or fumes from one floor to other or from outside to any occupied building or structure.

Many high-rise buildings integrate smoke management systems into their conventional HVAC systems. In such installation, it requires special design considerations, including safe and adequate controls, acceptable and documented testing, and regular maintenance systems.

Wherever batteries are provided, the same shall be segregated by 120 min fire rated construction. Ventilation to the room shall be provided as per manufacturer's instructions.

### b) Air Handling Unit

- i) From fire safety point of view, Separate air handling units (AHU) for each floor shall be provided so as to avoid the hazards arising from spread of fire and smoke through the air conditioning ducts. The air ducts shall be separate from each AHU to its floor and in no way shall interconnect with the duct of any other floor. Within a floor it would be desirable to have separate air handling unit provided for each compartment.

Air handling unit shall be provided with effective means for preventing circulation of smoke through the system in the case of a fire in air filters or from other sources drawn into the system and shall have smoke sensitive devices for actuation in accordance with the accepted standard and control.

- ii) Shafts or ducts <sup>8</sup>, if penetrating multiple floors, shall be of masonry construction with fire damper in connecting ductwork or shall have fire rated ductwork with fire dampers at floor crossing. Alternatively, the duct and equipment may be installed in room having walls, doors and fire damper in duct exiting/entering the room of 120 min fire resistance rating. Such shafts and ducts shall have all passive fire control meeting 120 min fire resistance rating requirement to meet the objective of isolation of the floor from spread of fire to upper and lower floors through shaft/duct work.
- iii) The air filters of the air handling units shall be made of non-combustible materials.
- iv) The air handling unit room shall not be used for storage of any combustible materials.

---

<sup>7</sup> Note : This provision shall not apply to A-2 and A-4 occupancies less than 15m in height.

<sup>8</sup> Zoned and compartmented HVAC systems are encouraged with and approach to avoid common exhaust shafts and fresh air intake shafts which will limit the requirements of such passive measure and fire rated duct work and dampers.

- c) Duct Work
- i) Air ducts serving main floor areas, corridors, etc, shall not pass through the exits/exit passageway/ exit enclosure. Exits and lift lobbies, etc, shall not be used as return air passage.
  - ii) As far as possible, metallic ducts shall be used even for the return air instead of space above the false ceiling.
  - iii) Wherever the ducts pass through fire walls or floors, the opening around the ducts shall be sealed with materials having fire resistance rating of the compartment. Such duct shall also be provided with fire dampers at all fire walls and floors unless such ducts are required to perform for fire safety operation; and in such case fire damper may be avoided at fire wall and floor while integrity of the duct shall be maintained with 120 min fire resistance rating to allow the emergency operations for fire safety requirements.
  - iv) The ducting within compartment would require minimum fire resistance rating of 30 min. Such ducting material in substantial gauge shall be in accordance. If such duct crosses adjacent compartment/floor and not having fire dampers in such compartment/floor, it will require fire resistance duct work rating of 120 min. The requirements of support of the duct shall meet its functional time requirement as above.
  - v) The materials used for insulating the duct system (inside or outside) shall be of non-combustible type. Any such insulating material shall not be wrapped or secured by any material of combustible nature.
  - vi) Inspection panels shall be provided in the ductwork to facilitate the cleaning accumulated dust in ducts and to obtain access for maintenance of fire dampers.
- d) Fire or Fire/Smoke Dampers
- i) These dampers shall be evaluated to be located in supply air ducts, fresh air and return air ducts/ passages at the following points:
    - At the fire separation wall,
    - Where ducts/passages enter the vertical shaft,
    - Where the ducts pass through floors, and
    - At the inlet of supply air duct and the return air duct of each compartment on every floor.
  - ii) Damper shall be of motorized type/fusible link.  
Damper shall be so installed to provide complete integrity of the compartment with all passive fire protection sealing. Damper should be accessible to maintain, test and also replace, if so required. Damper shall be integrated with Fire Alarm Panel and shall be sequenced to operate as per requirement and have interlocking arrangement for fire safety of the building. Manual operation facilities for damper operation shall also be provided.

## 8 Heating

- a) Installation of Chimney and heating apparatus shall be in accordance with the good practice (*Refer Annexure K (10)*).
- b) Boiler Rooms
  - i) Provisions of boiler and boiler rooms shall conform to The Boilers Act, 1923.
  - ii) Further, the following additional aspects may be taken into account in the location of boiler room:
    - The boilers shall be installed in a fire resisting room of 180 min fire resistance rating.
    - Entry to this room shall be provided with a composite door of 120 min fire resistance rating.
    - The boiler room shall be provided with its dedicated natural or mechanical ventilation system. Mechanical ventilation system for the boiler room would be

accepted with 120 min fire resistance rating ductwork, if it has interface with other mechanical areas. Ventilation system should not be allowed to be routed through electrical room area or through exit corridor/exits.

- The oil tank for the boiler shall be provided with a dyked enclosure having a volumetric capacity of at least 10 percent more than the volume of the oil tank. The enclosure shall be filled with sand for a height of 300 mm.

## 9 Glazing

- a) The glazing shall be in accordance with Part VI Structural Design, Section VIII Glass and Glazing, of the National Building Code. The entire glazing assembly shall be rated to that type of construction as given in Table No. 14.3. The use of glass shall not be permitted for enclosures of exits and exit passageway.

This shall be applicable along with other provisions of this Part related to respective uses as specified therein. The use of glass shall not be permitted for enclosures of exits and exit passageway.

- b) Glass facade shall be in accordance with the following:

- i) For fully sprinklered<sup>9</sup> buildings having fire separation of 9 m or more, tempered glass in a non-combustible assembly, with ability to hold the glass in place, shall be provided. It shall be ensured that sprinklers are located within 600 mm of the glass facade providing full coverage to the glass.

- ii) All gaps between floor-slabs and facade assembly shall be sealed at all levels by approved fire-resistant sealant material of equal fire rating as that of floor slab to prevent fire and smoke propagation from one floor to another.

- iii) Openable panels shall be provided on each floor and shall be spaced not more than 10 m apart measured along the external wall from centre-to-centre of the access openings. Such openings shall be operable at a height between 1.2 m and 1.5 m from the floor and shall be in the form of openable panels (fire access panels) of size not less than 1000 mm X 1000 mm opening outwards.

The wordings, FIRE OPENABLE PANEL OPEN IN CASE OF FIRE, DO NOT OBSTRUCT of at least 25 mm letter height shall be marked on the internal side. Such panels shall be suitably distributed on each floor based on occupant concentration. These shall not be limited to cubicle areas and shall be also located in common areas/corridors to facilitate access by the building occupants and fire personnel for smoke exhaust in times of distress.

## 10 Surface Interior Finishes

- a) The use of combustible surface finishes on walls (including facade of the building) and ceilings affects the safety of the occupants of a building. Such finishes tend to spread the fire and even though the structural elements may be adequately fire resistant, serious danger to life may result. It is, therefore, essential to have adequate precautions to minimise spread of flame on wall, facade of building and ceiling surfaces. The finishing materials used for various surfaces and decor shall be such that it shall not generate toxic smoke/fumes.

- b) The susceptibility of various types of wall surfaces to fire is determined in terms of the rate of spread of flame. Based on the rate of spread of flame, surfacing material shall be considered as divided into four classes as follows:

- i) Class 1 Surfaces of very low flame spread.  
ii) Class 2 Surfaces of low flame spread.

---

<sup>9</sup> In case of all other buildings, fire resistance rating of glass facade shall be in accordance with Table No. 14.3.



- iii) Class 3 Surfaces of medium flame spread.
  - iv) Class 4 Surfaces of rapid flame spread.
- c) The uses for which surface materials falling into various classes shall be adopted in building construction are given below:

Table No. 14.4: Surface Material details for various uses as per class

Class 1 (1)	Class 2 (2)	Class 3 (3)
May be used in any situation	May be used in any situation, except on walls, facade of the building, staircase, and corridors.	May be used only in living rooms and bedrooms (but not in rooms on the roof) and only as a lining to solid walls and partitions <sup>1)</sup> ; not on staircases or corridors or facade of the building.
<sup>1)</sup> Panelling (lining) shall be permitted in a limited area. It shall not be permitted in a vestibule.		

- d) Materials of Class 4 which include untreated wood fibreboards may be used with due fire-retardant treatment as ceiling lining, provided the ceiling is at least, 2.4 m from the top surface of the floor below, and the wall surfaces conform to requirements of class. Class 4 materials shall not be used in kitchens, corridors and staircases. Some materials contain bitumen and, in addition to risk from spread of fire, emit dense smoke on burning; such materials shall be excluded from use under these conditions and shall also not be used for construction of ceiling where the plenum is used for return air in air-conditioned buildings.
- e) When frames, walls, partitions or floors are lined with combustible materials, the surfaces on both sides of the materials shall conform to the appropriate class, because there is considerable danger from fire starting and rapidly spreading within the concealed cavity unknown to the occupants whose escape may be hampered thereby. For detailed information on materials and details of construction with their fire resistance rating, reference may be made to good practice (*Refer Annexure K (12)*).
- 11 Fire Command Centre (FCC)
- a) Fire command centre shall be on the entrance floor of the building having direct access. The control room shall have the main fire alarm panel with communication system (suitable public address system) to aid floors and facilities for receiving the message from different floors.
  - b) Fire command centre shall be constructed with 120 min rating walls with a fire door and shall be provided with emergency lighting. Interior finishes shall not use any flammable materials. All controls and monitoring of fire alarm systems, pressurization systems, smoke management systems shall happen from this room. Monitoring of integrated building management systems, CCTVs or any other critical parameters in building may also be from the same room.
  - c) Details of all floor plans along with the details of firefighting equipment and installations (2 sets laminated and bound) shall be maintained in fire command centre.
  - d) The fire staff in charge of the fire command centre shall be responsible for the maintenance of the various services and firefighting equipment and installations in coordination with security, electrical and civil staff of the building.

## **14.3 Life Safety**

### **14.3.1 General**

Every building shall be so designed, constructed, equipped, maintained and operated as to provide adequate means of egress to avoid undue danger to the life and safety of the occupants from fire, smoke, fumes or panic during the time period necessary for escape.

For high occupancy areas, it may be required to have annunciation, announcements and voice guided/aided system to direct the occupants towards safe egress routes, areas of comparative safety or exits, and to avoid situation of panic during distress.

Every main occupancy may have certain occupancies which may be incidental to the main occupancy. The exit requirements pertaining to such incidental occupancies from the floor of the occupancy to the level of exit discharge shall be calculated to meet the requirement of the actual occupancy of such type, to ensure adequate means of egress of the occupants.

Refer Part III Development Control Rules and General Building Requirements, National Building Code for accessibility for elderly and persons with disabilities, for various requirements for enabling a smooth and safe egress.

### **14.3.2 General Exit Requirements**

- 1 An exit may be a fire exit doorway; an internal staircase, exit passageway, external doorway, external staircase, and these having access to the street or to a veranda or to a refuge area or to the terrace or roof of a building. An exit may also include a horizontal exit leading to an adjoining building/fire compartment having its further access to unlocked/public exit at the same level.
- 2 Unless otherwise specified, lifts, escalators, moving walks and revolving doors shall not be considered as exits and shall not constitute any part of the required exit.
- 3 Every exit, exit passageway and exit discharge shall be continuously maintained free of all obstructions or impediments to full use in the case of fire or other emergency.
- 4 Every building having human occupancy shall be provided with exits sufficient to permit safe egress of occupants, in case of fire or other emergency.
- 5 In every building or structure, exits shall comply with the minimum requirements of this Part, except those not accessible for general public use.
- 6 No building shall be so altered as to reduce the number, width or protection of exits to less than that required.
- 7 For non-naturally ventilated areas, fire doors with 120 min fire resistance rating shall be provided and particularly at the entrance to lift lobby and stair well where a funnel or flue effect may be created, inducing an upward spread of fire, to prevent spread of fire and smoke.
- 8 Exits shall be so arranged that they may be reached without passing through another occupied unit/passage in others control, if they pose challenge or restriction in means of egress.
- 9 Doors in exits shall open in the direction of exit. In case of assembly building (Group E) and Health (Group D-1), exit door shall not open immediately upon a flight of stair and all such entries to the stair shall be through a landing, so that such doors do not impede movement of people descending from a higher floor when fully opened. While for other occupancies, such doors shall not reduce the pathway in the landing by more than half the width of such staircase. Overhead or sliding doors shall not be installed.
- 10 At least half of the required exit stairs from upper floors (rounded to the next higher number) shall discharge directly to the exterior or through exit passageways.
- 11 Unless otherwise specified, all the exits and exit passageways to exit discharge shall have a clear ceiling height of at least 2.4 m. However, the height of exit door shall be at least 2.0 m.
- 12 Where changes in elevation of more than 300 mm are encountered in the exits, ramps or sloped surfaces shall be used with handrails and floor finish materials that contrast with the adjacent finish materials.

- 13 The capacity of the means of egress required from any storey of the building shall not be reduced along the path of egress travel until arrival to the exit discharge.
- 14 The lifts, escalators, moving walks, turnstiles and revolving doors shall not be considered in determining the required capacity of means of egress for the individual floor(s) or the building.
- 15 Turnstiles or similar devices that restrict travel to one direction or that are used to restrict unauthorized entry shall not be so placed as to obstruct any required means of egress. Alternative door openings of required exit width shall be available within 3 m of such devices, if installed.
- 16 Suitable means shall be provided so that all access-controlled exit doors, turnstiles, boom barriers and other such exits shall automatically operate to open mode during emergencies like fire, smoke, acts of terrorism, etc, so that people can safely and quickly egress into safe areas outside. If required, a master controlling device may be installed at a strategic location to achieve this.
- 17 Penetrations into and openings through an exit are prohibited except those necessary like for the fire protection piping, ducts for pressurization and similar life safety services. Such openings as well as vertical passage of shaft through floors shall be protected by passive systems.
- 18 Walking surfaces in exit access shall comply with the following requirements for smooth exit:
  - a) Walking surfaces shall be nominally level.
  - b) The slope of walking surface in the direction of travel shall not exceed 1 in 20 unless the ramp requirements are met.
  - c) Slope perpendicular to the direction of travel shall not exceed 1 in 48.
  - d) Walking surfaces shall be slip-resistant along the entire path of travel.
- 19 Basement
  - a) Basement exits shall be sufficient to provide for the capacity of the basement as determined in accordance with Rule No. 14.3.4(2). In no case shall there be less than two independent basement exits.
  - b) Basements having incidental occupancies to main occupancy shall be planned with exit requirements of the basements for the actual occupancy within the basement.
  - c) Where basement is used for car parking and also there is direct approach from any occupancy above to the basement, door openings leading to the basement shall need to be protected with fire doors with 120 min fire rating, except for exit discharge doors from the basements.

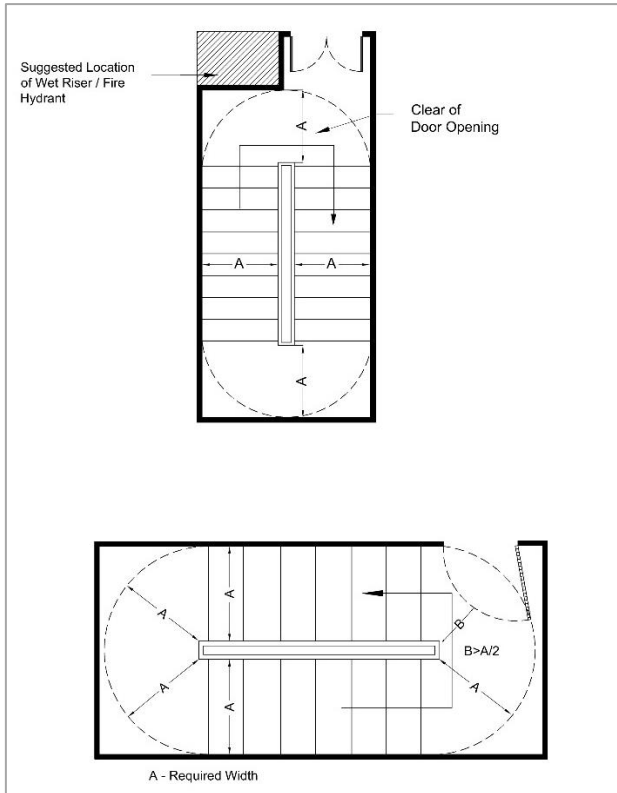

Figure No. 14.5: Door Locations at Landing in Fire Exists

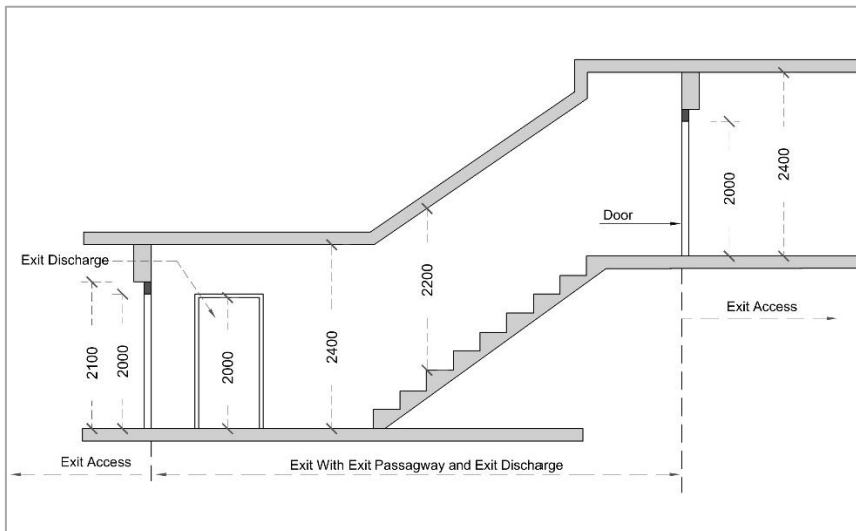

Figure No. 14.6: Minimum Head Room Measurement

### 14.3.3 Occupant Load

For determining the exits required, the number of persons within any floor area or the occupant load shall be based on the actual number of occupants declared, but in no case less than that specified in Table No. 14.1. The occupant load of a mezzanine floor discharging to a floor below shall be added to that floor occupancy and the capacity of the exits shall be designed for the total occupancy load thus established.

The occupant load of each story considered individually shall be required to be used in computing the number of means of egress at each story, provided that the required number of means of egress is not decreased in the direction of egress travel.

The assembly occupancies and call centres shall be required to display, limiting occupant load details positioned in a conspicuous place near the entrance of each of such respective occupancy to avoid possible overcrowding and overloading. The display shall preferably be engraved on a metal plate of not less than 300 mm × 200 mm, with letters of height and width not less than 50 mm, with detail of occupancy, area and occupancy load.

The capacity of any open mezzanine/balcony shall be added to the capacity of the floor below for the purpose of determining exit capacity.

<b>MAXIMUM OCCUPANCY</b>
<b>____ PERSONS PERMITTED WITHIN THIS SPACE/ROOM</b>
IT IS CONFIRMED THAT THE FIRE EXITS ARE PLANNED FOR EGRESS OF THE OCCUPANCY AS MENTIONED ABOVE AND OCCUPANCY MORE THAN THE ABOVE IS NOT PERMITTED IN THE SPACE/ROOM AS FOLLOWS:
SPACE/ROOM DETAIL: _____
FLOOR NO. _____
SIGN: _____ DATE: _____
(MANAGER/AUTHORIZED SIGNATORY)

#### 14.3.4 Egress Components

Egress components to be considered are the number of exits to which access is provided, capacity of exit access, travel distance to an exit, the obviousness of the direction to an exit, and any hindrance including due to security issues involved.

##### 1 Exit Access

- a) A common path of travel is desirable in exit access which leads to two independent directions to separate exits.
- b) Capacity of exit access: The width of corridors, aisles or ramps required for exit access shall be sufficient to ensure a smooth flow of occupants to the exit. Where a corridor is the only way of access to an exit, the corridor width shall not be less than the calculated exit width.
- c) Objects like tables, chairs or any other temporary/permanent structures in exit access corridors shall be avoided as this may result in congestion and impeding smooth flow of personnel during emergencies.
- d) In order to ensure that each element of the means of egress can be effectively utilized, they shall all be properly lit and marked. Lighting shall be provided with emergency power back-up in case of power failures. Also, exit signs of adequate size, marking, location, and lighting shall be provided so that all those unfamiliar with the location of the exits may safely find their way.
- e) Exit access to fireman's lift and refuge area on the floor shall be step free and clearly sign posted with the international symbol of accessibility.
- f) Exit access shall not pass through storage rooms, closets or spaces used for similar purpose.
- g) The calculation of capacity of exit access shall be in accordance with Rule No. 14.3.2(4).

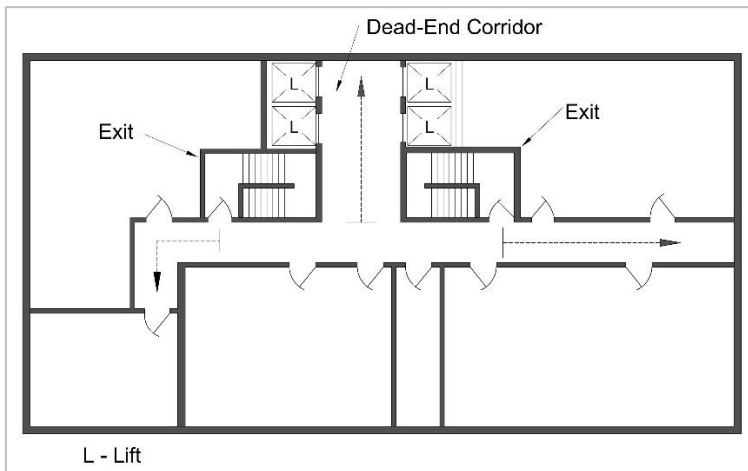

Figure No. 14.7: Dead End Corridor

## 2 Exits

### a) Number of Exits

The minimum required number of exits in a building shall be determined based on occupant load (*Refer Table No. 14.1*) and width required per person (*Refer No. Table 14.1*) as appropriate to the type of exit for respective occupancies, subject to complying with maximum travel distance requirement (*Refer Table No. 14.1*).

### b) Arrangement of Exits

- i) Exits shall be so located that the travel distance on the floor shall not exceed the distance (*Refer Table No. 14.1*).
- ii) Travel distance shall be measured from the most remote point within a storey or a mezzanine floor along the natural and un-obstructed path of horizontal or vertical egress travel to the door to an exit.
- iii) The dead-end corridor length in exit access shall not exceed 6 m for educational, institutional and assembly occupancies. For other occupancies, the same shall be 15 m. (*Refer Figure No. 14.7*).
- iv) Exits shall be placed as remote from each other as possible and shall be arranged to provide direct access in separate directions from any point in the area served.

### c) Capacities of means of egress.

- i) Exit capacity is the number of people that can pass through a stairway, and level components (door and corridor) and ramps. The total capacity of all the respective means of egress serving a floor shall be sufficient to allow egress of the entire population of the floor.
- ii) The unit of exit width, used to measure the capacity of any exit, shall be 500 mm. A clear width of 250 mm shall be counted as an additional half unit. Clear widths less than 250 mm shall not be counted for exit width.
- iii) Width per person for stairways, and level components and ramps shall be determined using the capacity factors in accordance with Table No. 14.1. For example, if an exit doorway measures 1000 mm in clear width, it would be defined as providing exit capacity for  $1000/6.5$  occupants, that is, 153 persons (say 150 persons) and number of such exit doorways can then be calculated depending on the occupant load.
- iv) When calculating stairways, level components and ramps and other exit means, the capacity of the entire system shall have to be based upon the minimum capacity available from any part of the system. The corridor, if so provided shall also to be planned with consideration of exit access adequacy for the number of occupants. Further, consider the situation of doors opening to an exit stairway. If the stairway provides an exit capacity of 150 persons, and the doors leading into the stairway

provide an exit capacity of 153 persons, the overall exit system would be considered to provide the minimum exit capacity of only 150 persons afforded by the stairway. The exit planning will be limited by the most restrictive exit calculation under the means of egress.

- v) In the procedures for determining required egress capacity, the number of required means of egress is based on a floor-by-floor consideration, rather than the accumulation of the occupant loads of all the floors. However, the number of means of egress cannot decrease as an occupant proceeds along the egress path.

d) Types of exit access and exits

Various types of exit access and exits are doorways, corridors and passageways, horizontal exits, internal staircases, exit passageways, external staircases, and ramps.

Requirements for each are as detailed below:

i) Doorways

- Every exit doorway shall open into an enclosed stairway or a horizontal exit of a corridor or passageway providing continuous and protected means of egress (*Refer Figure No. 14.8*).
- No exit doorway shall be less than 1000 mm in width except assembly buildings, where door width shall be not less than 2000 mm (*Refer Figure No. 14.9*). Doorways shall be not less than 2000 mm in height.
- Exit doorways shall be operable from the side which they serve, without the use of a key.
- Mirrors shall not be placed on exit doors and in exits to avoid confusion regarding the direction of exit.
- Revolving doors can be accepted as a component in a means of egress where the following requirements are fully complied with:
  - Doors shall be capable of collapsing to a book fold position with parallel egress paths, of width not less than 1000 mm.
  - Doors shall not be located within 3 m of the foot or top of stairs or escalators. A dispersal area shall be provided between the stairs or escalators and the doors.
  - Each revolving door shall be provided with a hinged door in the same wall within 3 m thereof, with same exiting capacity.
  - Each revolving door shall be considered as capable of exiting only 50 persons.
- All fire rated doors and assembly shall be provided with certificate and labels prominently indicating the manufacturer's identification, door details covering door type, serial/batch number, month and year of manufacture, fire resistance rating, etc. The doors and assembly shall be certified with all prescribed hardware such as hinges, locks, panic bars, door closer, and door viewers.
- Access controlled doors: Access controlled doors and electromagnetic doors shall fall under this category. These shall meet the following requirements:
  - Doors shall have fire rating as per the requirements at the location of installation.
  - Activation of the building automatic sprinkler or fire detection system, if provided, shall automatically unlock the doors in the direction of egress, and the doors shall remain unlocked until the automatic sprinkler system or fire-alarm system has been manually reset.
  - Loss of power to the part of the access control system that locks the doors shall automatically unlock the doors in the direction of egress.
  - A manual release device shall be provided in the readily accessible vicinity of the egress door with a signage PUSH TO EXIT and when the same is operated, it shall result in direct interruption of power to the lock, independent of the access control system electronics.

- Turnstiles: Turnstiles or similar devices that restrict travel to one direction or are used to collect fares or admission charges shall not be placed so as to obstruct any required means of egress unless door openings of required width are available within 3m thereof. Turnstiles or such similar devices shall also be disengaged through automatic or manual intervention to allow egress in the direction of exit.
  - Doors in folding partition shall not be treated as approved means of egress.
- ii) Corridors and passageways of means of egress.
- Corridors and passageways shall be of width not less than the calculated aggregate width of exit doorways leading from them in the direction of travel to the exit (*Refer Table No. 14.1*).
  - In the case of buildings where there is a central corridor, which is part of exit access, the doors of rooms (except for rooms having assembly occupancy) shall open inwards to permit smooth flow of traffic in the corridor.

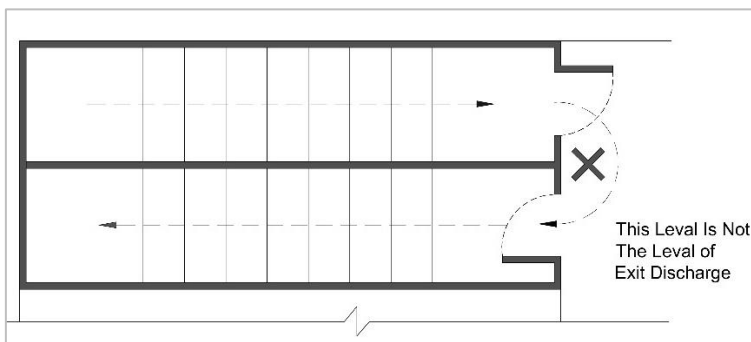

Figure No. 14.8: Unacceptable Arrangement for Enclosing a Stair Serving as a Required Exit

iii) Staircases

- General

The requirements of number of staircases shall supplement the requirement of different occupancies in accordance with Rule No. 14.5.

All buildings, as mentioned in accordance with Rule No. 14.1.1, shall have a minimum of two staircases. The actual number of staircases shall comply with the requirement of Rule No. 14.3.4(2). All exit staircases shall discharge, at the level of exit discharge, to the exit discharge, either,

- directly, or
- through an exit passageway, or
- through a large lobby.

At least 50 percent of the staircases shall discharge directly and/or through an exit passageway.

The minimum width of tread without nosing shall be 250 mm for staircase of residential buildings. This shall be minimum 300 mm for assembly, hotels, educational, institutional, business and other buildings. The treads shall be constructed and maintained in a manner to prevent slipping. The maximum height of riser shall be 190 mm for staircase of residential buildings (A-1) and 150 mm for other buildings. The number of risers shall be limited to 12 per flight. The staircases may be internal staircases or external staircases.



Table No. 14.4A: Staircase Details

No	Use	Staircase		
		Minimum Flight Width (m)	Minimum Tread (mm)	Maximum Riser (mm)
(1)	(2)	(3)	(4)	(5)
1	Residential(A-2) Note- For row housing with 2 storeys, the minimum width shall be 0.75	1	300 <sup>1</sup>	150 <sup>2</sup>
2	Residential (A-1, A-3, and A-4)	1.25		
3	Residential hotel (A-5 and A-6)	1.50		
4	Assembly Note- The width of stairs may be accepted to be 1.50m in case of assembly occupancy having less than 150 persons	2.00		
5	Educational	1.50		
6	Institutional	2.00		
7	All other occupancies	1.50		

\*Note:

1 For one or two family dwelling, it may be reduced to not less than 250mm

2 For one or two family dwelling, it may be increased to not more than 190mm. The number of risers shall be limited to 12 per flight

- Internal staircases  
The internal staircases may be constructed with an external wall, or otherwise, and shall comply with the following:
  - Internal stairs shall be constructed of non-combustible materials throughout, and shall have fire resistant rating of minimum 120 min.
  - A staircase shall not be arranged round a lift shaft.
  - Exits shall not be used as a portion of a supply, return or exhaust air system serving adjoining areas. Any opening(s) shall not be permitted in walls or in doors, separating exits from adjoining areas.
  - No flue chimney, electromechanical equipment, air conditioning units, gas piping, or electrical panels shall be allowed in the stairway.
  - Notwithstanding the detailed provision for exits in accordance with Rule No. 14.3.2 and Rule No. 14.3.3, the minimum width shall be provided for staircases (*Refer Table No. 13.2 of Part 3(I)*).
  - A handrail shall be provided on one side of the staircase of width less than 1500 mm, and on both sides of the staircase of width 1500 mm and more. The projection of handrail(s) in the staircase width shall not be more than 115 mm. All other requirements of handrail shall be in accordance with Part III ‘Development Control Rules and General Building Requirements’, National Building Code.
  - Handrails may project inside the measured width by not more than 90 mm.
  - The design of staircase shall also take into account the following:
    - The minimum headroom in a passage under the landing of a staircase and under the staircase shall be 2.2 m.
    - Access to exit staircase shall be through a fire door of a minimum 120 min fire resistance rating.

- No living space, store or other fire risk shall open directly into staircases.
- The exit (including staircases) shall be continuous from refuge floors or terrace level, as applicable, to the level of exit discharge.
- No electrical shafts/air conditioning ducts or gas pipes, etc, shall pass through or open in the staircases.
- Lifts shall not open in staircase.
- No combustible material shall be used for decoration/wall panelling in the staircase.
- Beams/columns and other building features shall not reduce the head room/ width of the staircase.
- The floor indication board, indicating the location/designated number of staircase, respective floor number and direction to exit discharge shall be placed inside the staircase, on the wall nearest to the fire door. It shall be of size not less than 300 mm × 200 mm.
- Individual floors shall be prominently indicated on the wall outside the staircase and facing it.
- All staircase shall terminate at the level of exit discharge. The access to the basement shall be by a separate staircase.
- Scissors type staircases shall not be treated as part of exit.

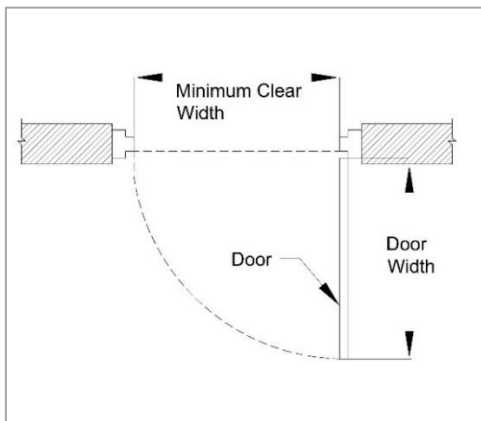

Figure No. 14.9: Minimum Clear Door Width

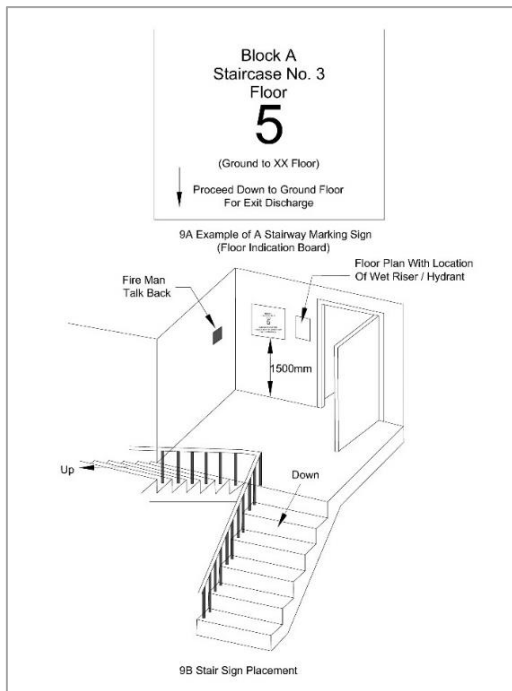

Figure No.14.10: Stair Marking and Requirement in Exit

- **Curved Staircase**  
Curved stairs shall not be treated as part means of egress. However, these may be used as part of exit access provided the depth of tread is not less than 280 mm at a point 350 mm from the narrower end of the tread and the smallest radius is not less than twice the stair width.
- **External staircases**  
The external staircases are the staircases provided on the external wall/facade, and shall comply with the following:
  - External stairs shall always be kept in sound and usable condition.
  - All external stairs shall be directly connected to the ground.
  - Entrance to the external stairs shall be separate and remote from the internal staircase.
  - Where an external staircase is provided, it shall be ensured that the use of it at the time of fire is not prejudiced by smoke and flame from openings (for example, windows, doors) in the external face of the building. Care shall be taken to ensure that no external wall or window opening opens on to or close to an external stair. If such openings exists within 3 m from an external staircase, they shall be protected with fire rated doors/window assemblies with rating of at least 60 min (*Refer Figure No. 14.11*).
  - The external stairs shall be constructed of non-combustible materials, and any doorway leading to it shall have minimum 120 min fire resistance.
  - No external staircase shall be inclined at an angle greater than 45° from the horizontal.
  - External stairs shall have straight flight not less than 1500 mm wide.
  - Handrails, to be provided on both sides, shall be of a height not less than 1000 mm and not exceeding 1200 mm. There shall be provisions of balusters with maximum gap of 150 mm.
  - The use of spiral staircase shall be limited to low occupant load and to a building not exceeding 9 m in height. A spiral staircase shall be not less than 1500 mm in diameter and shall be designed to give adequate headroom.

- Ramps
  - Ramps shall comply with all the applicable requirements for staircases regarding enclosure, capacity (*Refer Table No. 14.1*) and limiting dimensions, except where specified in Rule No. 14.5 for special uses and occupancies.
  - The slope of a ramp shall be in accordance with Rule 13.1.3 of Part 3(I).
  - Ramp(s) shall be surfaced with approved slip resistant materials that are securely attached. No perforations are permissible on ramp floors.
  - Any changes in travel direction in ramp shall be preceded by landings of 1.5 m × 1.5 m size.
  - Ramps and intermediate landings shall continue with no decrease in width along the direction of egress travel.
  - Outside ramps and landings shall be designed to minimise water accumulation on their surfaces.
  - Ramps shall have landings located at the top, at the bottom, and at doors opening onto the ramp.
  - Every landing shall be not less than 1500 mm long in the direction of travel.
  - Where the ramp is not part of an accessible route, the ramp landings shall not be required to exceed 1250 mm in the direction of travel, provided that the ramp has a straight run.
  - Handrails shall be provided on all ramps on both sides.

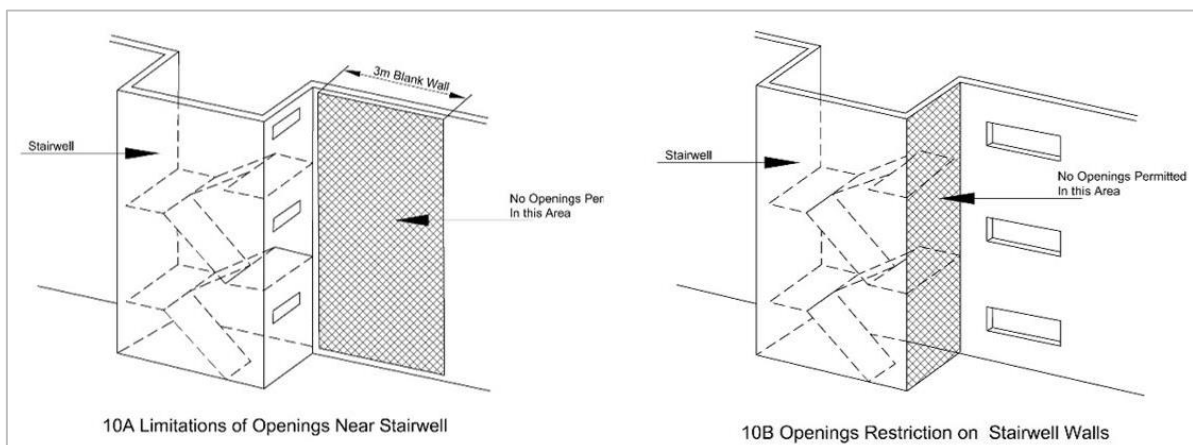

Figure No. 14.11: Opening Restrictions

- e) Smoke Control of Exits
  - i In building design, compartmentation plays a vital part in limiting the spread of fire and smoke. The design should ensure avoidance of spread of smoke to adjacent spaces through the various leakage openings in the compartment enclosure, such as cracks, openings around pipes ducts, airflow grills and doors. In the absence of proper sealing of all these openings, smoke and toxic gases will obstruct the free movement of occupants of the building through the exits. Pressurization of staircases is of great importance for the exclusion of smoke and toxic gases from the protected exit.
  - ii Pressurization is a method adopted for protecting the exits from ingress of smoke, especially in high-rise buildings. In pressurization, air is injected into the staircases, lobbies, etc, as applicable, to raise their pressure slightly above the pressure in adjacent parts of the building. As a result, ingress of smoke or toxic gases into the exits will be prevented. The pressurization of staircases and lift lobbies shall be adopted as given in Table No. 14.5. The pressure difference for staircases shall be 50 Pa.

Pressure differences for lobbies (or corridors) shall be between 25 Pa and 30 Pa. Further, the pressure differential for enclosed staircase adjacent to such lobby (or corridors) shall be 50 Pa. For enclosed staircases adjacent to non-pressurized lobby (or corridors), the pressure differential shall be 50 Pa.

- iii Equipment and ductwork for staircase pressurization shall be in accordance with one of the following:
  - Directly connected to the stairway by ductwork enclosed in non-combustible construction.
  - If ducts used to pressurize the system are passed through shafts and grills are provided at each level, it shall be ensured that hot gases and smoke from the building cannot ingress into the staircases under any circumstances.
- iv The normal air conditioning system and the pressurization system shall be designed and interfaced to meet the requirements of emergency services. When the emergency pressurization is brought into action, the following changes in the normal air conditioning system shall be effected.
  - Any re-circulation of air shall be stopped, and all exhaust air vented to atmosphere.
  - Any air supply to the spaces/areas other than exits shall be stopped.
  - The exhaust system may be continued provided,
    - the positions of the extraction grills permit a general air flow away from the means of egress.
    - the construction of the ductwork and fans is such that, it will not be rendered inoperable by hot gases and smoke; and
    - there is no danger of spread of smoke to other floors by the path of the extraction system which can be ensured by keeping the extraction fans running.
- v For pressurized stair enclosure systems, the activation of the systems shall be initiated by signalling from fire alarm panel.
- vi Pressurization system shall be integrated and supervised with the automatic/manual fire alarm system for actuation.
- vii Wherever pressurized staircase is to be connected to unpressurized area, the two areas shall be segregated by 120 min fire resistant wall.
- viii Fresh air intake for pressurization shall be away (at least 4 m) from any of the exhaust outlets/grille.

Table No. 14.5: Pressurization of Staircases and Lift Lobbies

No	Component <sup>1)</sup>	Width per Person (mm)		
		Less than 15 m	15 m to 30 m	More than 30 m
(1)	(2)	(3)	(4)	(5)
i)	Internal staircase not with external wall	Pressurized except for residential buildings (A-1 and A-3(Apartment houses))	Pressurized	Pressurized
ii)	Internal staircase with external wall	Pressurized except for residential buildings (A-1 and A-3(Apartment houses)) or naturally ventilated	Naturally ventilated or pressurized	Cross-ventilated or pressurized
iii)	Lift lobby	Not required at ground and above However lift lobby segregation and pressurization is required for lift commuting from ground to basement	Naturally ventilated or Pressurized <sup>1)</sup>	Cross-ventilated or Pressurized <sup>1)</sup>

<sup>1)</sup> Lift lobby with fire doors (120 min) at all levels with pressurization of 25-30 Pa is required. However, if lift lobby cannot be provided at any of the levels in air-conditioned buildings or in internal spaces where funnel/flue effect may be created, lift hoist way shall be pressurized at 50 Pa. For building greater than 30 m, multiple point injection air inlets to maintain desired pressurization level shall be provided. If the lift lobby, lift and staircase are part of firefighting shaft, lift lobby necessarily has to be pressurized in such case, unless naturally ventilated.

Notes

- The natural ventilation requirement of the staircase shall be, achieved through opening at each landing, of an area 0.5 m<sup>2</sup> in the external wall. A cross ventilated staircase shall have 2 such openings in opposite/adjacent walls or the same shall be cross ventilated through the corridor.
- Enclosed staircases leading to more than one basement shall be pressurized.

### 14.3.5 Compartmentation

#### 1 General

- It is important to limit the spread of a fire in any building. The usual method is to use fire barriers. In some instances, these barriers need to be penetrated for ductwork, plumbing and electrical systems, and in such cases, use of passive fire protection measures shall be done so that the integrity of these barriers is not compromised.
- Floor(s) shall be compartmented with area as given below.

- All floors shall be compartmented/zoned with area of each compartment being not more than 750 m<sup>2</sup>. The maximum size of the compartment shall be as follows, in case of sprinklered basement/building:

Table No.14.6: Maximum Compartmentation Area of Sprinklered Basement/ Buildings

No.	Use	Compartmentation Area (m <sup>2</sup> )
(1)	(2)	(3)
1	Basement car parking	3000
2	Basements (other than car parking)	2000
3	Health Buildings:	
	Subdivision D-1	1800
4	Public Buildings:	
	Subdivision D-2	1125
5	Mercantile and Assembly building	2000
6	Business building	3000
7	All other building (Excluding low hazard and moderate hazard industrial building and storage building) <sup>1)</sup>	750

<sup>1)</sup> Compartmentation for low hazard and moderate hazard industrial buildings and storage buildings shall be done in consultation with local fire department.

In addition, there shall be requirement of a minimum of two compartments if the floor plate size is equal or less than the areas mentioned above. However, such requirement of minimum two compartments shall not be required, if the floor plate is less than 750 m<sup>2</sup>.

Compartmentation shall be achieved by means of fire barrier having fire resistance rating of 120 min.

#### **14.3.6 Smoke Control**

##### **1 Smoke Exhaust and Pressurization of Areas Above Ground**

- a) Corridors in exit access (exit access corridor) are created for meeting the requirement of use, privacy, and layout in various occupancies. These are most often noted in hospitality, health care occupancies and sleeping accommodations.
- b) Exit access corridors of guest rooms and indoor patient department/areas having patients lacking self-preservation and for sleeping accommodations such as apartments, custodial, penal and mental institutions, etc, shall be provided with 60 min fire resistant wall and 20 min self-closing fire doors along with all fire stop sealing of penetrations.
- c) Smoke exhaust system having make-up air and exhaust air system or alternatively pressurization system with supply air system for these exit access corridors shall be required.
- d) Smoke exhaust system having make-up air and exhaust air system shall also be required for theatres/auditoria. Such smoke exhaust system shall also be required for large lobbies, and which have exit through staircase leading to exit discharge. This would enable eased exit of people through smoke-controlled area to exit discharge.
- e) All exit passageway (from exit-to-exit discharge) shall be pressurized or naturally ventilated. The mechanical pressurization system shall be automatic in action with manual controls in addition. All such exit passageway shall be maintained with integrity for safe means of egress and evacuation. Doors provided in such exit passageway shall be fire rated doors of 120 min rating. Smoke exhaust system where provided, for above areas and occupancies shall have a minimum of 12 air changes per hour smoke exhaust mechanism. Pressurization system where provided shall have a minimum pressure differential of 25-30 Pa in relationship to other areas.
- f) The smoke exhaust fans in the mechanical ventilation system shall be fire rated, that is, 250°C for 120 min. For naturally cross-ventilated corridors or corridors with operable windows, such smoke exhaust system or pressurization system will not be required.

##### **2 Smoke Exhaust and Pressurization of Areas Below Ground**

Each basement shall be separately ventilated. Vents with cross-sectional area (aggregate) not less than 2.5 percent of the floor area spread evenly round the perimeter of the basement shall be provided in the form of grills, or breakable stall board lights or pavement lights or by way of shafts.

Alternatively, a system of mechanical ventilation system may be provided with following requirements:

- a) Mechanical ventilation system shall be designed to permit 12 air changes per hour in case of fire or distress call. However, for normal operation, air changes schedule shall be as given in Part VIII Building Services, Section 3 Air conditioning, Heating and Mechanical Ventilation., National Building Code.
- b) In multi-level basements, independent air intake and smoke exhaust shafts (masonry or reinforced concrete) for respective basement levels and compartments therein shall be planned with its make-up air and exhaust air fans located on the respective level and in the respective compartment. Alternatively, in multi-level basements, common intake masonry (or reinforced cement concrete) shaft may serve respective compartments aligned at all basement levels. Similarly, common smoke exhaust/outlet masonry (or reinforced cement concrete) shafts may also be planned to serve such compartments at all basement levels.

All supply air and exhaust air fans on respective levels shall be installed in fire resisting room of 120 min. Exhaust fans at the respective levels shall be provided with back draft damper connection to the common smoke exhaust shaft ensuring complete isolation and compartmentation of floor isolation to eliminate spread of fire and smoke to the other compartments/floors.

- c) Due consideration shall be taken for ensuring proper drainage of such shafts to avoid insanitation condition. Inlets and extracts may be terminated at ground level with stall board or pavement lights as before. Stall board and pavement lights should be in positions easily accessible to the fire brigade and clearly marked AIR INLET or SMOKE OUTLET with an indication of area served at or near the opening.
- d) Smoke from any fire in the basement shall not obstruct any exit serving the ground and upper floors of the building.
- e) The smoke exhaust fans in the mechanical ventilation system shall be fire rated, that is, 250°C for 120 min.
- f) The smoke ventilation of the basement car parking areas shall be through provision of supply and exhaust air ducts duly installed with its supports and connected to supply air and exhaust fans. Alternatively, a system of impulse fans (jet fans) may be used for meeting the requirement of smoke ventilation complying with the following:
  - i Structural aspects of beams and other down stands/services shall be taken care of in the planning and provision of the jet fans.
  - ii Fans shall be fire rated, that is, 250°C for 120 min.
  - iii Fans shall be adequately supported to enable operations for the duration as above.
  - iv Power supply panels for the fans shall be located in fire safe zone to ensure continuity of power supply.
  - v Power supply cabling shall meet circuit integrity requirement in accordance with accepted standard. The smoke extraction system shall operate on actuation of flow switch actuation of sprinkler system. In addition, a local and/or remote manual start-stop control/switch shall be provided for operations by the fire fighters. Visual indication of the operation status of the fans shall also be provided with the remote control. No system relating to smoke ventilation shall be allowed to interface or cross the transformer area, electrical switchboard, electrical rooms or exits. Smoke exhaust system having make-up air and exhaust air system for areas other than car parking shall be required for common areas and exit access corridor in basements/underground structures and shall be completely separate and independent of car parking areas and other mechanical areas. Supply air shall not be less than 5 m from any exhaust discharge openings.

### **14.3.7 Gas Supply**

#### **1 Town Gas/LPG Supply Pipes**

Where gas pipes run in buildings, the same shall run in separate shafts exclusively for this purpose and these shall be on external walls, away from the staircases.

Gas distribution pipes shall always be below the false ceiling. The length of these pipes shall be as short as possible. In the case of kitchen cooking range area, hood should have grease filters using metallic grill to trap oil vapours escaping into the fume hood.

#### **2 Thermal Detectors**

These shall be installed into fume hoods of large kitchens for hotels, hospitals, and similar areas located in high rise buildings. Arrangements shall be made for automatic tripping of the exhaust fan in case of fire. If gas is used, the same shall be shut off.

The voltage shall be 24 V or 100 V d.c. operated with external rectifier. The valve shall be of the hand re-set type and shall be located in an area segregated from cooking ranges. Valves shall be easily accessible. The hood shall have manual facility for steam or suitable hood extinguishing gas released depending on duty condition.

#### **3 Gas cylinders and manifold shall need to be housed in a detached location with no other occupancy within distances prescribed in good practice (*Refer Annexure K (14)*). There shall be**



an enclosure suitably ventilated. It is desirable to provide medium velocity spray nozzles which can be operated by quick opening valve situated away from the enclosure.

- 4 In the case of gas cylinders, if manifold has to be installed on podium/close to podium, the same shall be away from any air intakes/smoke exhaust openings/ any windows.
- 5 Pressure regulating stations shall be designed and installed at critical locations for excess flow shut off valves. Seismic shut off valve at the main distribution point shall be installed for buildings in D-6 occupancy and institutional occupancy above 15 m.
- 6 Gas meters shall be housed in a suitably constructed metal cupboard located in a well-ventilated space, keeping in view the fact that LPG is heavier than air and town gas is lighter than air.
- 7 Wherever LPG reticulation/cylinders are used in buildings above 100 m, gas leak detectors shall be provided at the usage points and monitored from fire command centre. The cables used for signalling shall be circuit integrity cables.
- 8 The gas lines shall not be installed through any electrical shafts, escape routes, refuge areas/refuge floors.
- 9 Kitchens working on LPG fuel shall not be permitted in basements.

#### **14.3.8 Hazardous Areas, Gaseous, Oil Storage Yard, etc**

Rooms containing high pressure boilers, refrigerating machinery, transformers or other service equipment subject to possible explosion shall not be located directly under or adjacent to exits. All such rooms shall be effectively cut-off from other parts of the building and shall be provided with adequate vents to the outside air. All rooms or areas of high hazard in additions to those hereinbefore mentioned, shall be segregated, or shall be protected with fire resistant walls having fire rating of 120 min as fire, explosion or smoke therefrom is likely to interfere with safe egress from the building. Further,

- 1 Each building shall be provided with an approved outside gas shut-off valve conspicuously marked. The detailed requirements regarding safe use of gas shall be as specified in Part IX Plumbing Services, Section IV Gas Supply, National Building Code; and
- 2 All exterior openings in a boiler room or rooms contain central heating equipment, if located below opening in another storey or if less than 3 m from other doors or windows of the same building shall be protected by a fire assembly (*Refer Rules 14.2.4 (4)*). Such assemblies shall be fixed, automatic or self-closing.

#### **14.3.9 Fire Detection and Alarm**

- 1 The requirements of fire detection and alarm systems are covered for each occupancy in Table No 14.7 and under Rules 14.5 for annunciation to occupants in view of the ensuing vulnerability and to warn occupants early of the existence of fire, so as to facilitate orderly and safe egress.
- 2 Fire detection and alarm systems in buildings shall be so planned and programmed so as to enable operations of various systems and equipment to facilitate requirements leading to life safety, compartmentation and fire protection. These systems and equipment may include electromechanical systems such as air handling units; pressurization systems; smoke management systems; creation of compartmentation through the release of fire barrier, hold-up fire doors, etc; and monitoring of fire water storage tanks and pumps, pressures in hydrant and sprinkler system, etc. These planning and requirements shall be based on building occupancy and other requirements on case-to-case basis.
- 3 Voice evacuation systems shall employ Hindi, English and vernacular language using pre-recorded messages and integrate with fire alarm panels for alerting the zone of fire and surrounding zones/floors as required for annunciation (*Refer Table No. 14.7 and its Note 1*).
- 4 Appropriate visual warning arrangement through visual strobes/beacons may be considered in appropriate situations particularly in public buildings, at required locations to ensure visual as well as alarm for persons with hearing impairment.
- 5 For assembly buildings, Health and Public /Public Office buildings and all buildings above 30 m in height where fire alarm system is provided in accordance to Table 7, detectors shall also be provided inside the electrical shafts, and lift machine rooms, etc, besides occupancy areas.

- 6 Fire alarm panels shall be connected in peer-to-peer network or with redundant cables, run in different shafts. Each panel shall be able to work in standalone mode and master slave architecture may be used where required.
- 7 The fire detection system shall be in accordance with accepted standards (*Refer Annexure K (15)*). Guidelines for selection of various types of fire detectors for different occupancies and their installation and maintenance shall be in accordance with good practice (*Refer Annexure K (16)*) and the Part XII, Asset and Facility Management, National Building Code.
- 8 In buildings where automatic fire alarm system is provided, the following shall be monitored from fire alarm panel:
  - a) Water level in all tanks.
  - b) Hydrant and sprinkler pressures of respective zones as provided.
  - c) Pump ON/OFF status.
  - d) All isolation valves, wherever provided with supervisory switch (non-padlock valves).
  - e) Other requirements to meet electro-mechanical services interface.

#### **14.3.10 Fire Officer**

- 1 A qualified Fire Officer with experience of not less than 3 years shall be appointed who will be available on the premises, for large educational complexes, business buildings with height 30 m and above<sup>10</sup>, Health and Public buildings of 15 m and above, Hospitality buildings B-2 and H-2 occupancy.
- 2 The Fire Officer shall,
  - a) maintain the firefighting equipment in good working condition at all times.
  - b) prepare fire orders and fire operational plans and get them promulgated.
  - c) impart regular training to the occupants of the buildings in the use of firefighting equipment provided on the premises and keep them informed about the fire emergency evacuation plan.
  - d) keep proper liaison with the city fire brigade.
  - e) ensure that all fire precautionary measures are observed at the times.

#### **14.3.11 Fire Drills and Fire Orders**

Fire notices/orders shall be prepared to fulfil the requirements of firefighting and evacuation from the buildings in the event of fire and other emergency. The occupants shall be made thoroughly conversant with their action in the event of emergency, by displaying fire notices at vantage points and also through regular training. Such notices should be displayed prominently in bold lettering. For guidelines for fire drills and evacuation procedures for high rise buildings, see Annexure D.

---

<sup>10</sup> NOTE — Competent authority having jurisdiction may insist on compliance of the above rules in case of buildings having very large areas even if the height is less than 30 m.

Table No.14.7: Minimum Requirements for Fire Fighting Installations

No.	Type of Building Occupancy	Type of Installation							Water Supply (litre)			Pump Capacity (litre/min.)		
		Fire Extinguisher	First Aid Hose Reel	Wet Riser	Down Corner	Yard Hydrant	Automatic Sprinkler system	Manually Operated Electronic Fire alarm system (MOEFA) (See Note 1)	Automatic Detection and alarm system (see note 2)	Under-ground Static Water Strong Tank Combined Capacity for Wet Riser Yard Hydrant and Sprinklers per Set of Pumps	Terrace Tank over Respective Tower Terrace	Pump Near Underground Static Water Tank (Fire Pump) with Minimum Pressure of 3.5 kg/cm <sup>2</sup> at Remotest Location	At the Terrace Tank Level with Minimum Pressure of 3.5 kg/cm <sup>2</sup>	
(1)	(2)	(3)	(4)	(5)	(6)	(7)	(8)	(9)	(10)	(11)	(12)	(13)	(14)	
<b>RESIDENTIAL BUILDING (A)</b>														
a)	One- or two-Family Private Dwellings (A-1)	NR	NR	NR	NR	NR	NR	NR	NR	NR	NR	NR	NR	
b)	Custodial Houses (A-2)													
	1)	Less than 10 m in height												
	i)	Up to 300 persons	R	R	NR	NR	NR	R (see Note 3)	R	NR	NR	10000 (5000) (see Note 5)	NR	450 (450) (see Note 5)
	ii)	More than 300 persons	R	R	NR	R	NR	R (see Note 3)	R	NR	NR	15000 (5000) (see Note 5)	NR	900 (450) (see Note 5)
	2)	10 m and above but not exceeding 15 m in height	R	R	R	NR	R	R (see Note 3)	R	R	100000	5000 (5000) (see Note 5)	(see Note 9)	NR
	3)	15 m and above but not exceeding 24 m in height	R	R	R	NR	R	R	R	R	150000	10000	(see Note 10)	NR
	4)	Above 24 m but not exceeding 30 m in height	R	R	R	NR	R	R	R	R	200000	20000	(see Note 10)	NR
c)	Dormitories and Apartment Houses (A-3)													
	1)	Less than 15 m in height	R	R	NR	NR	NR	R (see Note 3)	NR	NR	NR	5000 (5000) (see Note 5)	NR	450 (450) (see Note 5)
	2)	15 m and above but not exceeding 35 m in height	R	R	NR	R	NR	R (see Note 3)	R (see Note 7)	NR	NR	25000	NR	900
	3)	Above 35 m but not exceeding 45 m in height	R	R	R	NR	NR	R (see Note 3 and Note 8)	R	NR	75000	5000	(see Note 9)	NR
<b>HOSPITALITY BUILDINGS (B)</b>														
a)	Hospitality (B-1)													
	1)	Less than 15 m in height												
	i)	Floor area not exceeding 300 m <sup>2</sup>	R	R	NR	NR	NR	R (see Note 3)	R	NR	NR	5 000 (5000)	NR	450 (450)

No.	Type of Building Occupancy	Type of Installation							Water Supply (litre)			Pump Capacity (litre/min.)	
		Fire Extinguisher	First Aid Hose Reel	Wet Riser	Down Corner	Yard Hydrant	Automatic Sprinkler system	Manually Operated Electronic Fire alarm system (MOEFA) (See Note 1)	Automatic Detection and alarm system (see note 2)	Under-ground Static Water Strong Tank Combined Capacity for Wet Riser Yard Hydrant and Sprinklers per Set of Pumps	Terrace Tank over Respective Tower Terrace	Pump Near Underground Static Water Tank (Fire Pump) with Minimum Pressure of 3.5 kg/cm <sup>2</sup> at Remotest Location	At the Terrace Tank Level with Minimum Pressure of 3.5 kg/cm <sup>2</sup>
(1)	(2)	(3)	(4)	(5)	(6)	(7)	(8)	(9)	(10)	(11)	(12)	(13)	(14)
	on any of the floor						3)				(see Note 5)		(see Note 5)
	ii) Floor area exceeding 300 m <sup>2</sup> but not more 1000 m <sup>2</sup> on any of the floor	R	R	R (see Note7)	NR	NR	R (see Note 3)	R	R	10000 for every 500 m <sup>2</sup> floor area subject to minimum of 50000 (see Note 6)	10000 (5000) (see Note 5)	(see Note 12 in case of provision of wet riser)	450 (450) (see Note 5)
	iii) Floor area exceeding 1000 m <sup>2</sup> on any of the floor	R	R	R (see Note 13)	NR	R	R	R (see Note 1)	R	100000 (see Note 13)	10000 (see Note 3)	(see Note 13 and Note 12)	NR
	2) 15 m and above but not exceeding 30 m	R	R	R	NR	R	R	R	R	150000	20000	(see Note 10)	NR
	3) Above 30 m in height	R	R	R	NR	R	R	R	R	200000	20000	(see Note 10)	NR
b)	Hospitality (B-2)	R	R	R	NR	R	R	R	R	250000	20000	(see Note 11)	NR
c)	Lodging and Rooming Houses (B-3)												
	1) Less than 15 m height												
	i) Up to 15 rooms	R	NR	NR	NR	NR	R (see Note 3)	NR	NR	NR	5000 (see Note 5)	NR	NR
	ii) More than 15 and up to 30 rooms	R	R	NR	NR	NR	R (see Note 3)	NR	NR	NR	5000 (5000) (see Note 5)	NR	450 (450) (see Note 5)
	iii) More than 30 rooms	R	R	NR	NR	NR	R (see Note 3)	R (see Note7)	NR	NR	10000 (5000) (see Note 5)	NR	450 (450) (see Note 5)
<b>EDUCATIONAL BUILDINGS (C)</b>													
	1) Less than 15 m in height												
	i) Ground plus one or more storeys	R	R	NR	NR	NR	R (see Note 3)	NR	NR	NR	10000 (5000) (see Note 5)	NR	450 (450) (see Note 5)
	2) 15 m and above but not exceeding 24 m in height	R	R	NR	R	NR	R (see Note 3)	R	NR	NR	25000	NR	900
	3) Above 24 m but not exceeding 30 m in height	R	R	R	NR	R	R (see Note 3)	R	NR	50000	(5 000) (see Note 5)	(see Note 12)	NR

No.	Type of Building Occupancy	Type of Installation							Water Supply (litre)			Pump Capacity (litre/min.)		
		Fire Extinguisher	First Aid Hose Reel	Wet Riser	Down Corner	Yard Hydrant	Automatic Sprinkler system	Manually Operated Electronic Fire alarm system (MOEFA) (See Note 1)	Automatic Detection and alarm system (see note 2)	Under-ground Static Water Strong Tank Combined Capacity for Wet Riser Yard Hydrant and Sprinklers per Set of Pumps	Terrace Tank over Respective Tower Terrace	Pump Near Underground Static Water Tank (Fire Pump) with Minimum Pressure of 3.5 kg/cm <sup>2</sup> at Remotest Location	At the Terrace Tank Level with Minimum Pressure of 3.5 kg/cm <sup>2</sup>	
(1)	(2)	(3)	(4)	(5)	(6)	(7)	(8)	(9)	(10)	(11)	(12)	(13)	(14)	
HEALTH & PUBLIC BUILDINGS (D)														
a)	Hospitals (D-1)													
	1)	Less than 15 m in height with plot area up to 1000 m <sup>2</sup>												
	i)	Up to ground plus one storey, with no beds	R	NR	NR	NR	NR	R (see Note 3)	R	NR	NR	(5000) (see Note 5)	NR	(450) (see Note 5)
	ii)	Up to ground plus one storey with beds	R	R	NR	NR	NR	R (see Note 3)	R	NR	NR	5000 (5000) (see Note 5)	NR	450 (450) (see Note 5)
	iii)	Ground plus two or more storeys, with no beds	R	R	NR	R	NR	R (see Note 3)	R	R	NR	10000 (5000) (see Note 5)	NR	900 (450) (see Note 5)
	iv)	Ground plus two or more two or more storeys, with beds	R	R	R	NR	NR	R	R (see Note 1)	R	75000	10000	(see Note 12)	NR
	2)	Less than 15 min height with plot area more than 1000 m <sup>2</sup>	R	R	R	NR	R	R	R (see Note 1)	R	100000	10000	(see Note 12)	NR
	3)	15 m and above but not exceeding 24 m in height	R	R	R	NR	R	R	R	R	150000	20000	(see Note 9)	NR
	4)	Above 24 m and not exceeding 45 m in height	R	R	R	NR	R	R	R	R	200000	20000	(see Note 10)	NR
b)	Public (D-2)													
	1)	Less than 10 m in height												
	i)	Up to 300 persons	R	R	NR	NR	NR	R (see Note 3)	R	NR	NR	10000 (5000) (see Note 5)	NR	450 (450) (see Note 5)
	ii)	More than 300 persons	R	R	NR	R	NR	R (see Note 3)	R	NR	NR	15000 (5000) (see Note 5)	NR	900 (450) (see Note 5)
	2)	10 m and above but not exceeding 15 m in height	R	R	R	NR	R	R (see Note 3)	R	R	100000	5000 (5000) (see Note 5)	(see Note 9)	NR
	3)	15 m and above but not	R	R	R	NR	R	R	R	R	150000	10000	(see Note 10)	NR

No.	Type of Building Occupancy	Type of Installation							Water Supply (litre)			Pump Capacity (litre/min.)	
		Fire Extinguisher	First Aid Hose Reel	Wet Riser	Down Corner	Yard Hydrant	Automatic Sprinkler system	Manually Operated Electronic Fire alarm system (MOEFA) (See Note 1)	Automatic Detection and alarm system (see note 2)	Under-ground Static Water Strong Tank Combined Capacity for Wet Riser Yard Hydrant and Sprinklers per Set of Pumps	Terrace Tank over Respective Tower Terrace	Pump Near Underground Static Water Tank (Fire Pump) with Minimum Pressure of 3.5 kg/cm <sup>2</sup> at Remotest Location	At the Terrace Tank Level with Minimum Pressure of 3.5 kg/cm <sup>2</sup>
(1)	(2)	(3)	(4)	(5)	(6)	(7)	(8)	(9)	(10)	(11)	(12)	(13)	(14)
	exceeding 24 m in height												
4)	24 m and above but not exceeding 30 m in height	R	R	R	NR	R	R	R	R	200000	20000	(see Note 10)	NR
c)	Public Office (D-3)												
1)	Less than 10 m in height	R	R	NR	R	NR	R (see Note 3)	R	NR	NR	10000 (5000) (see Note 5)	NR	450 (450) (see Note 5)
2)	Above 10 m but not exceeding 15 m in height	R	R	R	NR	NR	R (see Note 3)	R	R	50000	5000 (5000) (see Note 5)	(see Note 12)	450 (450) (see Note 5)
3)	Above 15 m and up to 24 m in height	R	R	R	NR	R	R	R	R	100000	10000	(see Note 9)	NR
4)	Above 24 m and up to 30 m in height	R	R	R	NR	R	R	R	R	150000	20000	(see Note 10)	NR
5)	Above 30 m in height	R	R	R	NR	R	R	R	R	200000	20000	(see Note 11)	NR
ASSEMBLY BUILDINGS (E)													
a)	Assembly Building (E-1 to E-4)												
1)	Less than 10 m in height												
i)	Up to 300 persons	R	R	NR	R	NR	R (see Note 3)	R	NR	NR	20000 (5000) (see Note 5)	NR	450 (450) (see Note 5)
ii)	More than 300 persons	R	R	NR	R	NR	R (see Note 3)	R	NR	NR	25000 (5000) (see Note 5)	NR	900 (450) (see Note 5)
2)	Above 10 m but not exceeding 15 m in height	R	R	R	NR	NR	R (see Note 3)	R (see Note 1)	R	100000	5000 (5000) (see Note 5)	(see Note 9)	450 (450) (see Note 5)
3)	Above 15 m but not exceeding 24 m in height	R	R	R	NR	R	R	R	R	150000	10000	(see Note 9)	NR
4)	Above 24 m but not exceeding 30 m in height	R	R	R	NR	R	R	R	R	200000	20000	(see Note 10)	NR
TRANSPORTATION (F)													
a)	Transportation (F-1)												
1)	Less than 10 m in height												
i)	Up to 300 persons	R	R	NR	R	NR	R (see Note 3)	R	NR	NR	20000 (5000)	NR	450 (450)

No.	Type of Building Occupancy		Type of Installation						Water Supply (litre)			Pump Capacity (litre/min.)		
			Fire Extinguisher	First Aid Hose Reel	Wet Riser	Down Corner	Yard Hydrant	Automatic Sprinkler system	Manually Operated Electronic Fire alarm system (MOEFA) (See Note 1)	Automatic Detection and alarm system (see note 2)	Under-ground Static Water Strong Tank Combined Capacity for Wet Riser Yard Hydrant and Sprinklers per Set of Pumps	Terrace Tank over Respective Tower Terrace	Pump Near Underground Static Water Tank (Fire Pump) with Minimum Pressure of 3.5 kg/cm <sup>2</sup> at Remotest Location	At the Terrace Tank Level with Minimum Pressure of 3.5 kg/cm <sup>2</sup>
(1)	(2)		(3)	(4)	(5)	(6)	(7)	(8)	(9)	(10)	(11)	(12)	(13)	(14)
								3)				(see Note 5)		(see Note 5)
	ii)	More than 300 persons	R	R	NR	R	NR	R (see Note 3)	R	NR	NR	25000 (5000) (see Note 5)	NR	900 (450) (see Note 5)
	2)	Above 10 m but not exceeding 15 m in height	R	R	R	NR	NR	R (see Note 3)	R (see Note 1)	R	100000	5000 (5000) (see Note 5)	(see Note 9)	450 (450) (see Note 5)
	3)	Above 15 m but not exceeding 24 m in height	R	R	R	NR	R	R	R	R	150000	10000	(see Note 9)	NR
	4)	Above 24 m but not exceeding 30 m in height	R	R	R	NR	R	R	R	R	200000	20000	(see Note 10)	NR
b)	Transportation (F-2)													
	1)	Below 15 m in height and covered area less than 250 m <sup>2</sup>	R	R	NR	NR	NR	R	NR	NR	NR	25000	NR	900
	2)	Below 15 min height and covered area more than 250m <sup>2</sup>												
		i) Ground floor only	R	R	R	NR	R	R	R	R	50000	10000	(see Note 12)	450
		ii) Ground plus one floor	R	R	R	NR	R	R	R	R	75000	10000	(see Note 9)	450
		iii) More than ground plus one floor	R	R	R	NR	R	R	R	R	100000	10000	(see Note 9)	450
	3)	Multi-Level Car Parking (MLCP)	R	R	R	NR	R	R	R	NR	150000	10000	(see Note 10)	900
<b>STORAGE BUILDINGS (G)</b>														
a)	Storage (G-1)													
	1)	Covered area up to 100 m <sup>2</sup>	R	NR	NR	NR	NR	R (see Note 3)	NR	NR	NR	5000 (see Note 4)	NR	450 (see Note 4)
	2)	Covered area more than 100 m <sup>2</sup> and up to 500 m <sup>2</sup>	R	R	NR	R (see Note 7)	NR	R (see Note 3)	NR	NR	NR	20 000 (5 000) (see Note 5)	NR	450 (450) (see Note 5)
	3)	Covered area more than 500 m <sup>2</sup> (for	R	R	NR	R	NR	R (see Note	R	NR	NR	20000 (5000)	NR	450 (450)

No.	Type of Building Occupancy		Type of Installation						Water Supply (litre)				Pump Capacity (litre/min.)	
			Fire Extinguisher	First Aid Hose Reel	Wet Riser	Down Corner	Yard Hydrant	Automatic Sprinkler system	Manually Operated Electronic Fire alarm system (MOEFA) (See Note 1)	Automatic Detection and alarm system (see note 2)	Under-ground Static Water Strong Tank Combined Capacity for Wet Riser Yard Hydrant and Sprinklers per Set of Pumps	Terrace Tank over Respective Tower Terrace	Pump Near Underground Static Water Tank (Fire Pump) with Minimum Pressure of 3.5 kg/cm <sup>2</sup> at Remotest Location	At the Terrace Tank Level with Minimum Pressure of 3.5 kg/cm <sup>2</sup>
(1)	(2)		(3)	(4)	(5)	(6)	(7)	(8)	(9)	(10)	(11)	(12)	(13)	(14)
		building height up to 15 m)						3)				(see Note 5)		(see Note 5)
	4)	Covered area more than 500 m <sup>2</sup> (for building height above 15 m)	R	R	R	NR	R	R (see Note 3)	R	R	75000	5000 (see Note 5)	(see Note 12)	NR
b)	Storage (G-2)													
	1)	Below 15 m in height and covered area less than 250 m <sup>2</sup>	R	R	NR	NR	NR	R	NR	NR	NR	25000	NR	900
	2)	Below 15 min height and covered area more than 250m <sup>2</sup>												
		i) Ground floor only	R	R	R	NR	R	R	R	R	50000	10000	(see Note 12)	450
		ii) Ground plus one floor	R	R	R	NR	R	R	R	R	75000	10000	(see Note 9)	450
		iii) More than ground plus one floor	R	R	R	NR	R	R	R	R	100000	10000	(see Note 9)	450
<b>MERCANTILE BUILDINGS (H)</b>														
a)	Mercantile (H-1)													
	1)	Less than 10 m in height	R	R	NR	R	NR	R (see Note 3)	R	NR	NR	10000 (5000) (see Note 5)	NR	450 (450) (see Note 5)
	2)	Above 10 m but not exceeding 15 m in height	R	R	R	NR	NR	R (see Note 3)	R	R	50000	5000 (5000) (see Note 5)	(see Note 12)	450 (450) (see Note 5)
	3)	Above 15 m and up to 24 m in height	R	R	R	NR	R	R	R	R	100000	10000	(see Note 9)	NR
	4)	Above 24 m and up to 30 m in height	R	R	R	NR	R	R	R	R	150000	20000	(see Note 10)	NR
	5)	Above 30 m in height	R	R	R	NR	R	R	R	R	200000	20000	(see Note 11)	NR
b)	Mercantile Buildings H-2													
			R	R	R	NR	R	R	R	R	200000	20000	(see Note 11)	NR
c)	Mercantile Buildings H-3 and H-4													
	1)	Less than 15 m in height												
		i) Ground plus one storey, with total of all floor area not exceeding 500 m <sup>2</sup>	R	R	NR	NR	NR	R (see Note 3)	NR	NR	NR	5 000 (5000) (see Note 5)	NR	450 (450) (see Note 5)



No.	Type of Building Occupancy		Type of Installation						Water Supply (litre)			Pump Capacity (litre/min.)		
			Fire Extinguisher	First Aid Hose Reel	Wet Riser	Down Corner	Yard Hydrant	Automatic Sprinkler system	Manually Operated Electronic Fire alarm system (MOEFA) (See Note 1)	Automatic Detection and alarm system (see note 2)	Under-ground Static Water Strong Tank Combined Capacity for Wet Riser Yard Hydrant and Sprinklers per Set of Pumps	Terrace Tank over Respective Tower Terrace	Pump Near Underground Static Water Tank (Fire Pump) with Minimum Pressure of 3.5 kg/cm <sup>2</sup> at Remotest Location	At the Terrace Tank Level with Minimum Pressure of 3.5 kg/cm <sup>2</sup>
(1)	(2)		(3)	(4)	(5)	(6)	(7)	(8)	(9)	(10)	(11)	(12)	(13)	(14)
	ii)	Ground plus one storey and total of all floor area exceeding 500 m <sup>2</sup>	R	R	NR	R	NR	R (see Note 3)	R	NR	NR	20000 (5000) (see Note 5)	NR	900 (450) (see Note 5)
	iii)	More than ground plus one storey	R	R	NR	R	NR	R (see Note 3)	R	NR	NR	25000 (5000) (see Note 5)	NR	900 (450) (see Note 5)
	2)	Above 15 m but not exceeding 24 m in height	R	R	R	NR	R	R	R	R	100000	10000	(see Note 9)	NR
	3)	Above 24 m but not exceeding 30 m in height	R	R	R	NR	R	R	R	R	200000	20000	(see Note 10)	NR
<b>BUSINESS BUILDINGS (I)</b>														
	1)	Less than 10 m in height	R	R	NR	R	NR	R (see Note 3)	R	NR	NR	10000 (5000) (see Note 5)	NR	450 (450) (see Note 5)
	2)	Above 10 m but not exceeding 15 m in height	R	R	R	NR	NR	R (see Note 3)	R	R	50000	5000 (5000) (see Note 5)	(see Note 12)	450 (450) (see Note 5)
	3)	Above 15 m and up to 24 m in height	R	R	R	NR	R	R	R	R	100000	10000	(see Note 9)	NR
	4)	Above 24 m and up to 30 m in height	R	R	R	NR	R	R	R	R	150000	20000	(see Note 10)	NR
	5)	Above 30 m in height	R	R	R	NR	R	R	R	R	200000	20000	(see Note 11)	NR
<b>INDUSTRIAL BUILDINGS (J)</b>														
a)	<b>Low Hazard (J-1)</b>													
	1)	Covered area up to 100 m <sup>2</sup>	R	NR	NR	NR	NR	R (see Note 3)	NR	NR	NR	5 000 (see Note 4)	NR	450 (see Note 4)
	2)	Covered area more than 100 m <sup>2</sup> and up to 500 m <sup>2</sup>	R	R	NR	R (see Note 7)	NR	R (see Note 3)	NR	NR	NR	20 000 (5 000) (see Note 5)	NR	450 (450) (see Note 5)
	3)	Covered area more than 500 m <sup>2</sup> (for building height up to 15	R	R	NR	R	NR	R (see Note 3)	R	NR	NR	20000 (5000) (see Note 5)	NR	450 (450) (see Note 5)

No.	Type of Building Occupancy	Type of Installation							Water Supply (litre)			Pump Capacity (litre/min.)	
		Fire Extinguisher	First Aid Hose Reel	Wet Riser	Down Corner	Yard Hydrant	Automatic Sprinkler system	Manually Operated Electronic Fire alarm system (MOEFA) (See Note 1)	Automatic Detection and alarm system (see note 2)	Under-ground Static Water Strong Tank Combined Capacity for Wet Riser Yard Hydrant and Sprinklers per Set of Pumps	Terrace Tank over Respective Tower Terrace	Pump Near Underground Static Water Tank (Fire Pump) with Minimum Pressure of 3.5 kg/cm <sup>2</sup> at Remotest Location	At the Terrace Tank Level with Minimum Pressure of 3.5 kg/cm <sup>2</sup>
(1)	(2)	(3)	(4)	(5)	(6)	(7)	(8)	(9)	(10)	(11)	(12)	(13)	(14)
	m)												
	4) Covered area more than 500 m <sup>2</sup> (for building height above 15 m)	R	R	R	NR	R	R (see Note 3)	R	R	75000	5000 (see Note 5)	(see Note 12)	NR
b)	Moderate Hazard (J-2)												
	1) Covered area up to 100 m <sup>2</sup>	R	R	NR	NR	NR	R	NR	NR	NR	10000	NR	450
	2) Covered area more than 100 m <sup>2</sup> and up to 500 m <sup>2</sup>	R	R	NR	NR	NR	R	NR	NR	NR	20000	NR	900
	3) Covered area more than 500 m <sup>2</sup> and up to 1000 m <sup>2</sup> (for height up to 15 m)	R	R	NR	R	NR	R	R	R	NR	50000	NR	900
	4) Covered area more than 500 m <sup>2</sup> and up to 1000 m <sup>2</sup> (for height above 15 m)	R	R	R	NR	R	R	R	R	100000	10000	(see Note 12)	NR
	5) Covered area more than 1000 m <sup>2</sup>	R	R	R	NR	R	R	R	R	150000	20000	(see Note 10)	NR
c)	High Hazard (J-3)												
	1) Covered area up to 50 m <sup>2</sup>	R	R	NR	NR	NR	R	NR	NR	NR	10000	NR	900
	2) Covered area more than 50 m <sup>2</sup> and up to 150 m <sup>2</sup>	R	R	NR	NR	NR	R	R	R	NR	25000	NR	900
	3) Covered area more than 150 m <sup>2</sup> and up to 300 m <sup>2</sup>	R	R	R	NR	NR	R	R	R	50000	10000	(see Note 12)	NR
	4) Covered area more than 300 m <sup>2</sup> and up to 500 m <sup>2</sup>	R	R	R	NR	R	R	R	R	100000	20000	(see Note 9)	NR
	5) Covered area more than 500 m <sup>2</sup>	R	R	R	NR	R	R	R	R	150000	20000	(see Note 10)	NR
R- Required NR-Not Required													
NOTES:													

- 1 MOEFA System shall also include talk-back system and public address system for the occupancies wherever mentioned in the table. These shall also be provided in car parking areas more than 300 m<sup>2</sup> and in multi-level car parking irrespective of their areas.
- 2 Automatic detection and alarm system is not required to be provided in car parking area. Such detection system shall however be required in other areas of car parking such as electrical rooms, cabins, and other areas.
- 3 Required to be installed in basement, if area of basement exceeds 200 m<sup>2</sup>.
- 4 Required to be provided if basement area exceeds 200 m<sup>2</sup>.
- 5 Additional values given in parenthesis shall be added if basement area exceeds 200 m<sup>2</sup>.
- 6 Required to be provided for buildings with more than two storeys (Ground + One).
- 7 Required to be provided for buildings with height above 15 m and above.
- 8 Sprinklers shall be fed water from both underground static water storage tank and terrace tank.
- 9 Provide required number of sets of pumps each consisting of one electric and one diesel pump (stand by) of capacity 2280 litre/min and one electric pump of capacity 180 litre/min (Refer Figure No. 14.12) (see also notes 15 and 16).
- 10 Provide required number of sets of pumps each consisting of two electric and one diesel pump (stand by) of capacity 2280 litre/min and two electric pump of capacity 180 litre/min (Refer Figure No. 14.13) (see also Notes 15 and 16).
- 11 Provide required number of sets of pumps each consisting of two electric and one diesel pump (stand by) of capacity 2850 litre/min and two electric pump of capacity 180 litre/min (Refer Figure No.14.13) (see also Notes 15 and 16).
- 12 Provide required number of sets of pumps each consisting of one electric and one diesel pump (stand by) of capacity 1620 litre/min and one electric pump of capacity 180 litre/min (Refer Figure No. 14.12) (see also Notes 15 and 16).
- 13 Required to be provided for buildings with more than one storey.
- 14 The requirements given in this table for Group J Industrial Buildings are for small scale industry units. For other industries the requirements will have to be worked out on the basis of relevant Indian Standards and also in consultation with the local fire authorities.
- 15 One set of pumps shall be provided for each 100 hydrants or part thereof, with a maximum of two sets. In case of more than one pump set installation, both pump sets shall be interconnected at their delivery headers.
- 16 Alternative to provisions of additional set of pumps, the objective can be met by providing additional diesel pump of the same capacity and doubling the water tank capacity as required for one set of pumps.
- 17 As per the requirement of local authority dry riser may be used in hilly areas, industrial areas or as required.
- 18 Unless so required by the Height of any Machinery (which shall be certified on case-to-case basis by Inspector of Factories), no building of height more than 18 m shall be allowed in J1 and J2 category and no building of height more than 15 m shall be allowed in J3 category.

## 14.4 Fire Protection

### 14.4.1 Fire Extinguishers/ Fixed Firefighting Installations

- 1 All buildings depending upon the occupancy use and height shall be protected by fire extinguishers, hose reels, wet riser, down-comer, yard hydrants, automatic sprinkler installation, deluge system, high/medium velocity water spray, foam, water mist systems, gaseous or dry powder system, manual/automatic fire alarm system, etc, in accordance with the provisions of various clauses given below, as applicable:
  - a) These fire extinguishing equipment, and their installation shall be in accordance with accepted standards. The extinguishers shall be mounted at a convenient height to enable its quick access and efficient use by all in the event of a fire incidence. The requirements of fire extinguishers/yard hydrant systems/wet riser/down-comer installation and capacity of water storage tanks and fire pumps, etc, (*Refer Table No.14.7*). The requirements regarding size of mains/risers (*Refer Table No 14.8*). The typical arrangements of down-comer and wet riser installations are shown in Figure No.14.14. The wet riser shall be designed for zonal distribution ensuring that unduly high pressures are not developed in risers and hosepipes.
  - b) First-aid firefighting appliances shall be provided and installed in accordance with good practice (*Refer Annexure K (18)*). The firefighting equipment and accessories to be installed in buildings for use in firefighting shall also be in accordance with the accepted standard (*Refer Annexure K (17)*) and shall be maintained periodically so as to ensure their perfect serviceability at all times.
  - c) Valves in fixed firefighting installations shall have supervisory switch with its signalling to fire alarm panel or to have chain(s), pad lock(s), label and tamper-proof security tag(s) with serial number to prevent tampering/unauthorized operation. These valves shall be kept in their intended open position.
  - d) In addition to wet riser or down-comer, first aid hose reels shall be installed in buildings (*Refer Table No. 14.7*) on all the floors, in accordance with accepted standard (*Refer Annexure K (19)*). The first-aid hose reel shall be connected directly to the riser/down-comer main and diameter of the hose reel shall not be less than 19 mm.
  - e) Wet risers shall be interconnected at terrace level to form a ring and cut-off shall be provided for each connection to enable repair/ maintenance without affecting rest of the system.
  - f) Pressure at the hydraulically remote hydrant and at the highest hydrant shall not be less than 3.5 bar. The pressure at the hydrants shall however not exceed 7.0 bar, considering the safety of operators. It may be planned to provide orifice plates for landing valves to control pressure to desired limit especially at lower levels; this could also be achieved through other suitable means of pressure reducing devices such as pressure-controlled hydrant valves.
  - g) Hydrants for firefighting and hose reels shall be located in the lobby in firefighting shaft. Those hydrants planned to be provided near fire exit staircase on the floor shall be within 5 m from exit door in exit access. Such hydrant cabinet may finish with doors to meet interior finishes with requirement of glass panel to provide visibility to the installations inside and inscribed with the word: FIRE HOSE CABINET of letter size 75 mm in height and 12 mm in width. Such door of the fire hose cabinet need not be fire resistant rated. The location of such cabinets shall be shown on floor plan and duly displayed in the landing of the respective fire exit staircase.
- 2 Static Water Storage Tanks and Pump House.
  - a) Static water storage tanks
    - i A satisfactory supply of water for the purpose of firefighting shall always be available in the form of underground/terrace level static storage tank with capacity specified for each building with arrangements or replenishment.
    - ii Water for the hydrant services shall be stored in an easily accessible surface/underground lined reservoir or above ground tanks of steel, concrete or masonry. The effective capacity of the reservoir above the top of the pump casing

(flooded suction) for various types of occupancies shall be as indicated in Table No. 14.7.

- iii Water for firefighting shall be stored in two or more interconnected compartments of equal size to facilitate cleaning and maintenance of the tanks without interrupting the water availability for firefighting.
- iv To prevent stagnation of water in the static water storage tank, the suction tank of the domestic water supply shall be fed only through an overflow arrangement from the fire water storage tanks to maintain the level therein at the minimum specified capacity.
- v Alternatively, domestic and fire water can be stored in two interconnected compartments as mentioned above. The suction inlet(s) for the domestic water pumps shall be so located at an elevation that minimum water requirements for firefighting as stated in Table No. 14.7 will be always available for fire pumps.
- vi The static storage water supply required for the above mentioned purpose shall entirely be accessible to the fire engines of the local fire service. Suitable number of manholes shall be provided for inspection, repairs, insertion of suction hose, etc. As an alternative to the arrangement of manholes to allow access from the top, suitable arrangement to enable efficient access to the tank by the firemen from the adjoining fire pump room having direct access from the ground level, shall be made. The underground fire water storage tank(s) shall not be more than 7 m in depth from the level having fire brigade draw-out connection, while the draw-out connection shall not be more than 5 m away from the tank wall. The covering slab shall be able to withstand a total vehicular load of 45 t (or as applicable) equally divided as a four-point load when the slab forms a part of pathway/driveway.
- vii The static water storage tank shall be provided with a fire brigade collecting head with 4 number 63 mm diameter (2 number 63 mm diameter for pump with capacity 1400 litre/min) instantaneous male inlets arranged in a valve box at a suitable point at street level. The same shall be connected to the static tank by a suitable fixed galvanized iron pipe not less than 150 mm in diameter to discharge water into the tank when required at the rate of 2250 litre/min, if tank is in the basement or not approachable for the fire engines.
- viii Each of the static water storage tanks shall also be provided with a fire brigade draw out collecting head with 63 mm diameter instantaneous male draw out arranged in a valve box at a suitable point at street level. This draw out shall be connected to galvanized iron pipe of 100 mm diameter with foot valve arrangement in the tank.

b) Firefighting pump house

The requirements shall be as given below:

- i It is preferable to install the pump house at ground level. Pump house shall be situated so as to be directly accessible from the surrounding ground level.
- ii Pump house shall be installed not lower than the second basement. When installed in the basement, staircase with direct accessibility (or through enclosed passageway with 120 min fire rating) from the ground, shall be provided. Access to the pump room shall not require to negotiate through other occupancies within the basement.
- iii Pump house shall be separated by fire walls all around and doors shall be protected by fire doors (120 min rating).
- iv Pump house shall be well ventilated and due care shall be taken to avoid water stagnation.
- v No other utility equipment shall be installed inside fire pump room.
- vi Insertions like flexible couplings, bellows, etc, in the suction and delivery piping shall be suitably planned and installed.
- vii Installation of negative suction arrangement and submersible pumps shall not be allowed.

- viii Pump house shall be sufficiently large to accommodate all pumps, and their accessories like PRVs, installation control valve, valves, diesel tank and electrical panel.
  - ix Battery of diesel engine operated fire pump shall have separate charger from emergency power supply circuit.
  - x Exhaust pipe of diesel engine shall be insulated as per best engineering practice and taken to a safe location at ground level, considering the back pressure.
  - xi Fire pumps shall be provided with soft starter or variable frequency drive starter.
- c) Automatic Sprinkler Installation
- i Automatic sprinklers shall be installed wherever required in terms of Table No. 14.7 throughout the building in accordance with good practice (*Refer Annexure K (20)*).
  - ii If selective sprinkling is adopted, there is a real danger of a fire starting in one of the unsprinklered area gathering momentum spreading to other areas and reaching the sprinklered areas as a fully developed fire. In such an event, the sprinklers can be rendered useless or ineffective.
  - iii Automatic sprinklers shall be installed in false ceiling voids exceeding 800 mm in height.
  - iv Installation of sprinklers may be excluded in any area to be used for substation and DG set.
  - v In areas having height 17 m or above such as in atria, sprinkler installations may be rendered ineffective and hence may be avoided.
  - vi Pressure in sprinkler system shall not exceed 12 bar or else high-pressure sprinkler to be installed for above 12 bar operations.
  - vii The maximum floor area on any one floor to be protected by sprinklers supplied by any one sprinkler system riser from an installation control valve shall be based on system protection area limitations considering maximum floor area on any one floor to be 4500 m<sup>2</sup> for all occupancies except industrial and hazardous occupancies, where Authorities shall be consulted for advice based on type and nature of risk.
  - viii Sprinkler installation control valves shall be installed inside the fire pump room.
  - ix For industrial buildings, such installation control valves may be installed outside the building and Authorities shall be consulted in situations where it is not possible to locate them inside the buildings. It is advisable to provide electrically operated siren for each valve outside the buildings in addition to water gongs in such case.
  - x The sprinkler flow switches provided shall be monitored by fire alarm panel.
  - xi It is essential to make provisions for avoiding water from sprinkler/hydrant operation entering lifts and electrical rooms.
  - xii Ramps at all levels shall be protected with sprinklers.

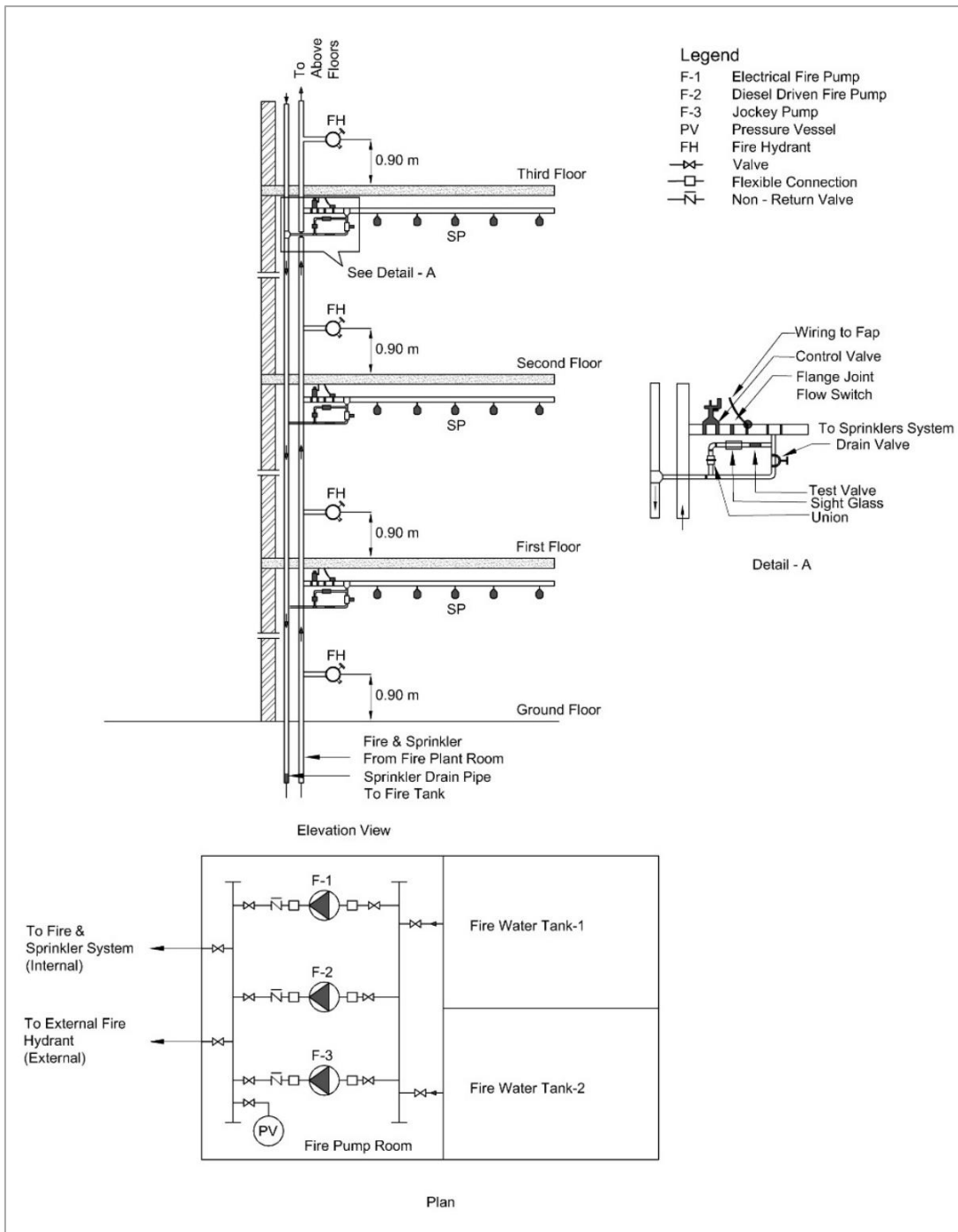

Figure No 14.12: Typical System of Pumping with One Electric, One Diesel Fire Pump

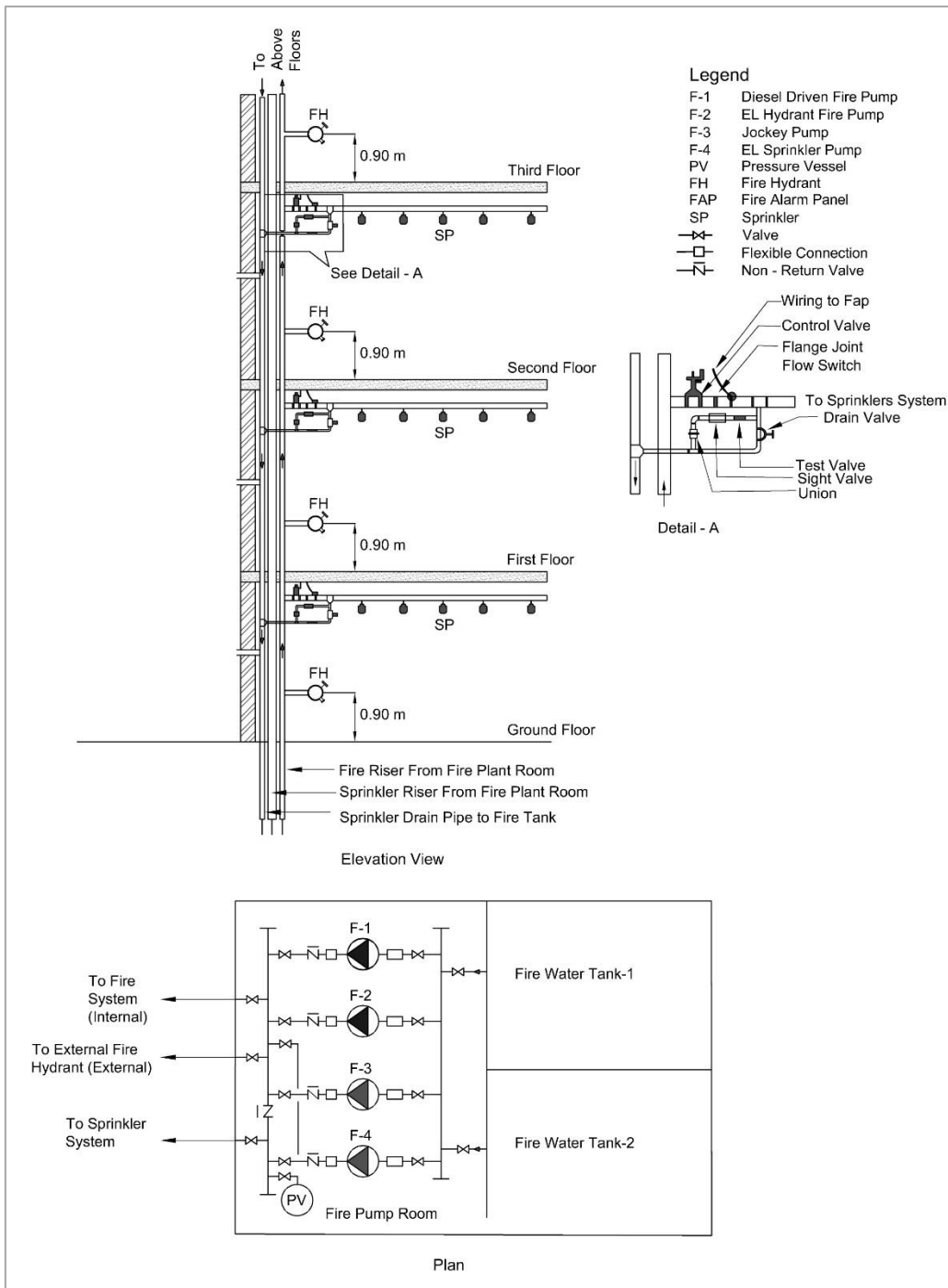

Figure No 14.13: Typical System of Pumping with Two Electric, One Diesel Fire Pump



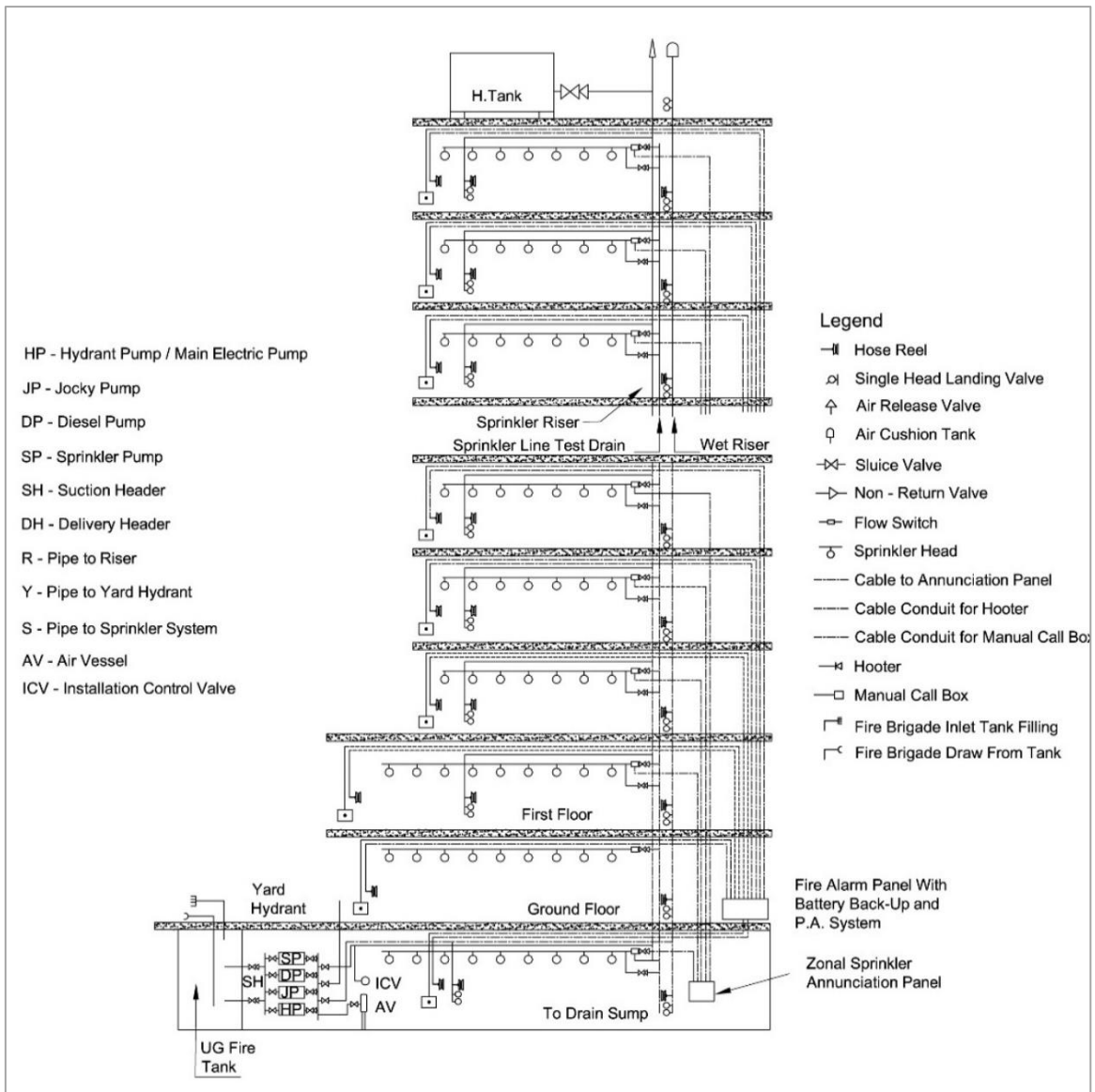

Figure No 14.14: Typical Arrangement of Wet Riser and Total Sprinkler System of Building

Table No.14.8: Size of the Mains

No.	Size of the Mains (mm)			Type of Building	Remarks		
(1)	(2)			(3)	(4)		
i)	100 mm with single outlet landing valves	a)	1	Residential buildings (A-3)	Up to 45 m height		
			2	Hospitality buildings (B-3)			
		b)	1	Educational building (B)	Up to 30 m height		
			1	Health and Public building (D)			
		c)	1	Health and Public building (D)	Up to 30 m height		
			2	Residential buildings (A-2)			
		d)			Assembly buildings (E)		
		e)	1		Business buildings (I)	Up to 45 m height	
			2		Public building (D-3)		
		f)			Mercantile buildings (H-3/ H-4)		
		g)	1		Industrial buildings (J)	Up to 15 m height	
			2		Storage buildings (G-1)		
		ii)	150 mm with single outlet landing valves	a)		Hospitality buildings (B-1)	Above to 45 m height
						Hospitality buildings (B-2)	
c)	1				Health and Public (D)	Above to 30 m height	
	2				Residential buildings (A-2)		
d)	1				Business buildings (I)	Above to 45 m height	
	2				Public buildings (D-3)		
e)	1				Industrial buildings (J)	Above to 15 m height	
	2				Storage buildings (G-1)		
f)	1				Storage buildings (G-2)	Up to 15 m height	
	2				Transportation (F-2)		

- d) Automatic High Velocity and Medium Velocity Water Spray Systems  
Automatic high velocity water spray or emulsifying system shall be provided for protection of outdoor and/ or indoor oil-cooled transformers as applicable in accordance with good practice (*Refer Annexure K (21)*) where applicable (*Refer Annexure E*). Also, medium velocity water spray system shall be provided for tankage (where applicable), conveyors, cable galleries and other occupancies listed in good practice (*Refer Annexure K (21)*).
- e) Fixed Foam Installation  
Fixed foam generating system shall be provided for protection of oil storage area for boilers with its ancillary storage of furnace oils in basement. Fixed foam installations can be low, medium or high expansion types, which can be provided based on the type of fire hazards identified in the facility. High expansion foams are used for cable tunnels and other confined areas. Design and installation of foam systems shall be governed by good practice (*Refer Annexure K (22)*).
- f) Gas Based Suppression System  
Gas based fire extinguishing installation shall be provided in accordance with good practice on premises where water or foam cannot be used for fire extinguishing because of the special nature of the contents of the buildings/areas to be protected where either the building(s) have very limited manpower or unmanned. The protection design for fixed carbon dioxide fire extinguishing system shall conform to good practice in all respects. For some special fire risk/essential applications, carbon dioxide may not be suitable and alternate provisions shall be made as per relevant standards (*Refer clause 14.4.1 (2(i))*).
- g) Firefighting equipment shall be suitably located and clearly marked by luminous signs.
- h) Automatic Water Mist Systems

These systems involve the use of fine water sprays for the efficient extinguishment of fires. These systems may be provided to protect areas in buildings for the uses as specified in good practice.

i) **Extinguishing Systems with Clean Agents**

Alternative systems for halon gas protection systems shall be provided where necessary as prescribed in this Part. These shall be in accordance with the accepted standards.

**14.4.2 Fire Detection and Alarm System**

*See Rule No. 14.3.9*

**14.4.3** The fixed firefighting installations and systems shall be maintained in accordance with good practice (*Refer Annexure K (26)*) and the Part XII 'Asset and Facility Management', National Building Code.

## **14.5 Additional Occupancy Wise Requirements**

- 14.5.1 Residential Buildings (Group A)
- 14.5.2 Hospitality Buildings (Group B)
- 14.5.3 Educational Buildings (Group C)
- 14.5.4 Health and Public Buildings (Group D)
- 14.5.5 Assembly Buildings (Group E)
- 14.5.6 Transportation (Group F)
- 14.5.7 Storage Buildings (Group G)
- 14.5.8 Mercantile Buildings (Group H)
- 14.5.9 Business Buildings (Group I)
- 14.5.10 Industrial Buildings (Group J)

### **14.5.1 Residential Buildings (Group A)**

- 1 Life Safety
  - a) Subdivision A-3 (Dormitories)
    - i Requirements of subdivision B-3 shall be applicable.
    - ii All sleeping rooms having occupancy of more than 10 persons shall have two separate and distinct exit access in different directions.
  - c) Subdivision A-3 (Apartment houses)
    - i In case of high-rise apartments, of the minimum exits as specified in clause 14.3.4(2), the naturally ventilated exit staircases may not require the provision of fire door. However, fire door shall be provided for all other staircases and pressurized staircases.
- 2 Additional Precautions
  - a) Flammable liquids for household purposes shall be kept in tightly stoppered or sealed containers. For the limits of quantities of flammable liquids to be allowed in various occupancies, reference may be made to appropriate regulations.
  - b) No stove or combustion heater shall be located directly under or immediately at the foot of stairs or otherwise so located as to block escape in case of malfunctioning of the stove or heater.
  - c) All kitchen exhaust fans, where provided, shall be fixed to an outside wall or to a duct of non-combustible material, which leads directly to the outside. The ducts shall not pass through areas having combustible materials. However, in case of centralized ducting, the duct shall be provided with adequate protection to limit the spread of fire.
  - d) Stores, engineering workshops, areas of high hazard, etc used for storage of substantial amount of flammable liquids shall be of 120 min fire resistance rating wall. Such areas shall be provided with fire doors, to be kept closed and shall be posted with a sign on each side of the door in 25 mm high block letters stating — ‘FIREDOOR — KEEP CLOSED’.

### **14.5.2 Hospitality Buildings (Group B)**

- 1 Life Safety
  - a) Subdivision B-1 / B-2
    - i Panic bars shall be provided in the fire exits. Panic bars shall be located at a height between 865 mm and 1220 mm from the floor level.
    - ii All guest rooms and suites shall be protected by extended throw, quick response type sprinklers only. Also, these areas shall be provided with audio-based detectors, having a sound level of at least 75 dB.
    - iii Horizontal-sliding doors shall not be used for door openings across corridors.
  - b) Subdivision B-3

- i All locking devices, which would impede or prohibit exit, such as chain type bolts, limited opening sliding type locks and burglar locks, which are not disengaged easily by quick releasing catches, shall be prohibited.
- ii All bathroom door locks or fasteners shall be designed to permit the opening of the locked or closed door from the outside in an emergency without the use of a special key.
- iii No lodging or rooming house shall have its sole means of egress pass through any non-residential occupancy in the same building.
- iv Rooming and lodging houses having floor area of 500 m<sup>2</sup> on any one or more floors shall have access to minimum two separate means of exits, at least one of which shall be so arranged as to have direct exit discharge.

## 2 Additional Precautions

It shall be in accordance with the additional precautions for Residential buildings Group A.

### 14.5.3 Educational Buildings (Group C)

#### 1 Fire Prevention

##### a) Subdivision C-1

- i Buildings intended for educational occupancy shall not be used for storage of any hazardous material.
- ii Gymnasiums, indoor stadiums and similar occupancies are permitted to have floors/running tracks of wood, cinder, synthetic or the like.

#### 2 Life Safety

##### a) Subdivision C-1

- i Every room with a capacity of over 45 persons in area shall have at least two doorways. Exit doors shall be operated by panic bars except that doors leading from classrooms directly to the outside may be equipped with the same type of lock as is used on classroom doors leading to corridor, with no provision whatsoever for locking against egress from the classroom.
- ii A building, which will have only the first floor and is accessible to not more than 20 pupils at any time, may be used for school purposes with the following exceptions:
  - Exterior walls or parts of walls which are less than 900 mm from adjacent property lines shall have no openings therein.
  - Classrooms may have only one exit not less than 900 mm wide.
- iii Rooms or areas for use by the preschool, kindergarten, Class/Grade 1 students shall be located on ground floor/level of exit discharge. Rooms or areas occupied by Class/Grade II students shall be located not above one floor higher than ground floor/level of exit discharge.
- iv Of the minimum exits as specified in clause 14.3.4(2), the naturally ventilated exit staircases, may not require provision of fire door. However, fire door shall be provided for all other staircases and pressurized staircases.

#### 3 Additional Precautions

##### a) Subdivision C-1

- i) Storage of volatile flammable liquids shall be prohibited, and the handling of such liquids shall be restricted to science laboratories only.
- ii) All exterior openings in a boiler room or rooms containing central heating equipment, if located below an opening in another storey or if less than 3 m from other doors or windows of the same building, shall be protected by a fire assembly as in clause 14.2.4(4). Such assemblies shall be of fixed, automatic or self-closing type.

#### 14.5.4 Health and Public (Group D)

##### 1 Fire Prevention

No combustible material of any kind shall be stored or used in any building or section thereof used for institutional occupancy, except as necessary to normal occupancy and use of the building.

##### 2 Life Safety

- a) The common path of travel shall be 30 m. The maximum dead end of corridor distance shall not exceed 6 m.
- b) Principle of progressive horizontal evacuation is of paramount consideration for hospital patients particularly those lacking self-preservation. This calls for moving occupants from a fire affected area to an adjoining area at the same level through a fire-resistant wall, to protect them from the immediate dangers of fire and smoke (*Figure No.14.15*).
- c) Progressive horizontal evacuation operates on the basis of evacuation from compartment to compartment and on use of adjacent compartments as temporary means of refuge. All compartments shall be divided with self-closing (door closers) fire doors with electromagnetic hold open. A coordinator shall be provided to sequence the closing of double leaf in case of emergency.
- d) Doors in fire resistant walls shall be so installed that these may normally be kept in open position but will close automatically. Corridor door openings shall be not less than 2.0 m in width of double swing double leaf type door. A coordinator shall be provided as above, for closing of double leaf in case of emergency.
- e) Exits and other features for penal and mental institutions, and custodial institutions shall be the same as specified for hospitals (Refer clause 14.5.3 (2)) in so far as applicable. Reliable means shall be provided to permit the prompt release of inmates from any locked section in case of fire or other emergency.
- f) All buildings or sections of buildings in penal and mental institution used for manufacturing, storage or office purposes shall have exits in accordance with the provisions of the Code for those occupancies.
- g) For hospitals (Subdivision D-1), the following shall also be complied with:
  - i) Compartmentation shall meet the requirement as per Rule No. 14.3.5
  - ii) Each compartment (*Refer Rule No. 14.3.5*) shall be able to accommodate, in addition to its own, the patients from adjoining compartment also considering 3.5 m<sup>2</sup> per person. If patients are not bed-ridden, a factor of 0.6 m<sup>2</sup> per person is recommended.
  - iii) All critical patients and those incapable of self-preservation and having physical impairment shall be housed within 30 m height.
  - iv) Other types of patients and occupancies incidental to the hospitals such as consultation rooms, nurses' stations, medical shops, canteens, etc may be housed at heights beyond 30 m but not more than 45 m.
  - v) Basement shall not be used to store flammables or for pathological or other laboratories particularly those involving usage of chemicals.
  - vi) Operation theatres, delivery rooms, intensive care units, recovery rooms, etc, that containing patients lacking self-preservation in case of emergencies shall be fire/smoke separated (120 min minimum rating) from all the adjoining areas.
  - vii) Aisles, corridors, ramps, etc, through which patients are moved, shall have a minimum width of 2.4 m throughout. Aisles, corridors, and ramps in other areas not intended for the housing, treatment, or use of inpatients shall be not less than 1.5 m in width.
  - viii) All exits from hospital or infirmary sections shall be not less than 2.0 m in width.
  - ix) Minimum width of door of single or double occupancy patient room shall be 1.25 m while for the wards for 3 to 5 patient beds shall be 1.50 m, to permit movement of patients. The minimum width of door for wards for more than 5 patient beds and for areas necessarily requiring patient evacuation on bed (such as ICU, recovery units,

delivery rooms, etc), shall have door width of 2.0 m. The width of 2.0 m may be reduced to minimum of 1.5 m where two such doors are provided in such areas.

- x Any sleeping accommodation or suite exceeding 100 m<sup>2</sup> in area shall have at least two doorways leading to the exit access corridors.
  - xi Floor surface of corridors shall not be inclined at a gradient steeper than 1 in 12 to the horizontal.
  - xii Exit access corridors from a compartment to another compartment shall be divided at the compartment intersection by a fire door of 120 min fire rating in the fire compartment wall.
  - xiii Rooms designated for laboratory and the like shall not exceed 100 m<sup>2</sup> in area and if additional space is required, fire separation of 120 min shall be provided.
  - xiv Storage of flammable liquids in laboratories or in any other area shall be not more than 3 litre for every 10 m<sup>2</sup> area.
  - xv Disposal of any equipment and other (particularly hazardous) materials shall be accomplished in the premises by a disposal specialist or at a safe location away from the health care facility by competent personnel using procedures established in concurrence with the safe practices.
  - xvi A stretcher lift in a lift bank shall also act as fireman's lift meeting the requirements of Part VIII 'Building Services, Section 5 Installation of Lifts, Escalators and Moving Walks, Subsection 5A Lifts', National Building Code.
- h) Progressive evacuation strategy (*Refer Figure No. 14.16*) in which, as an example, the exit calculations at two locations shall be based on requirements of total occupancy for area (A, B, C and D) divided by 2 considering progressive evacuation strategy.

### 3 Exception and Deviation

It is recognized that in institutions or part of buildings housing various types of psychiatric patients, or used as mental institutions and penal institutions, it is necessary to maintain locked doors and barred windows; and to such extent the necessary provision in other sections of the code requiring the keeping of exits unlocked may be waived. It is also recognized that certain type of psychiatric patients are not capable of seeking safety without adequate guidance. In buildings where this situation prevails, reliable means for the rapid release of occupants shall be provided, such as remote control of locks, or by keying all locks to keys commonly used by attendants.

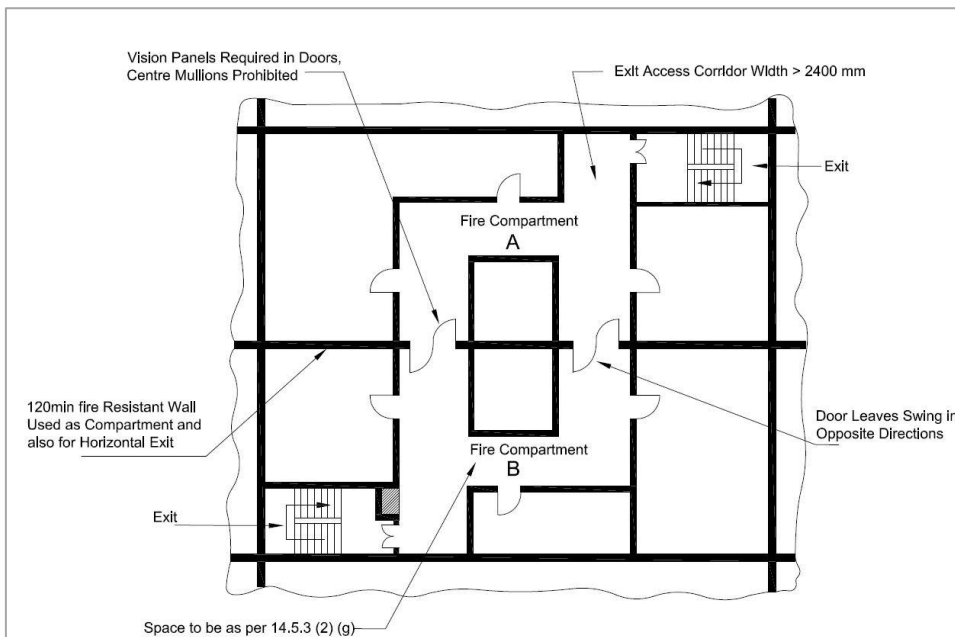

Figure No. 14.15: Part Plan Indicating Concept of Horizontal Exit in Hospital

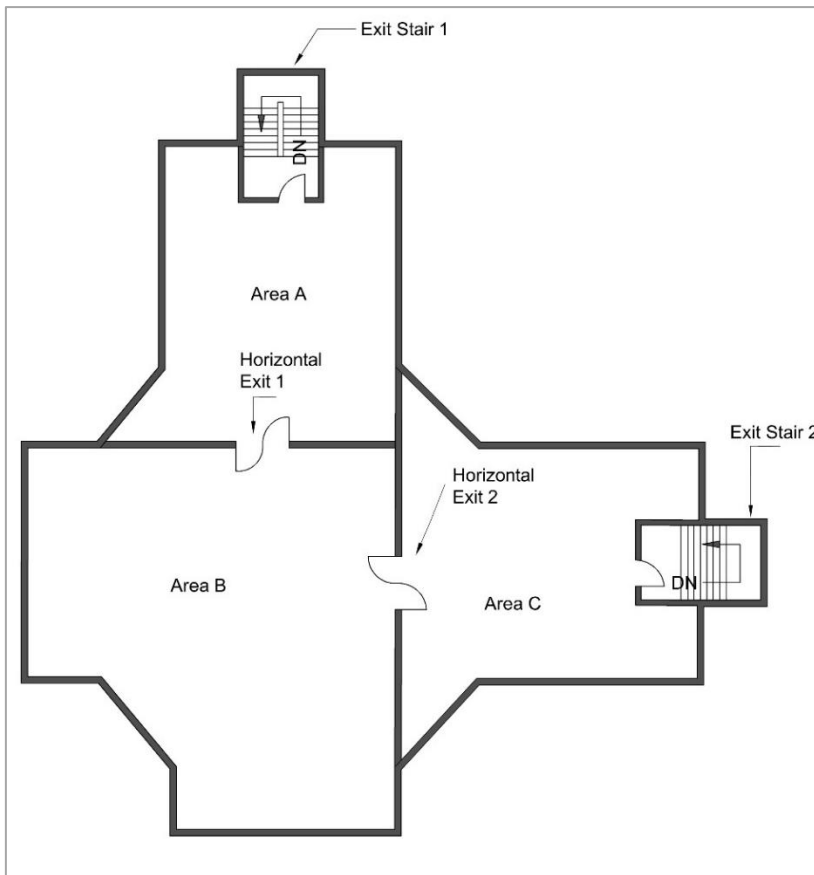

Figure No. 14.16: Minimum of Two Exits Accessible from all Parts of Floor

#### 14.5.5 Assembly/ Religious (Group E)

##### 1 Fire Prevention

- a) The following shall be applicable:
  - i Decorations of places of assembly shall be of non-flammable materials. Fabrics and papers used for such purpose shall be treated with an effective flame-retardant material. Stage settings made of combustible materials shall likewise be treated with fire retardant materials of Class 1 flame spread.
  - ii Gymnasiums, indoor stadiums and similar occupancies are permitted to have floors/ running tracks of wood, cinder, synthetic or the like.

##### 2 Life Safety

- a) The following shall be applicable:
  - i Exit door width for assembly buildings shall not be less than 2.0 m.
  - ii Every place of assembly of sub-division E-2 shall have at least four separate exits as remote from each other as practicable.
  - iii Every place of assembly of sub-division E-2 shall have at least two separate exits as remote from each other as practicable and if of capacity over 600, at least three exits shall be provided with each exit not less than of 2.0 m width.
  - iv Clear aisles not less than 1.2 m in width shall be formed at right angles to the line of seating in such number and manner that no seat shall be more than seven seats away from an aisle. Rows of seats opening on to an aisle at one end only shall have not more than seven seats.
  - v Under the conditions, where all these aisles do not directly meet the exit doors, cross aisles shall be provided parallel to the line of seating so as to provide direct access to the exit, provided that not less than one cross aisle for every 10 rows shall be required.



The width of cross-aisles shall be minimum of 1 m. Steps shall not be placed in aisles to overcome differences in levels, unless the gradient exceeds 1 in 10.

- vi The fascia of boxes, balconies and galleries shall have substantial railings not less than 1000 mm high above the floor. The railings at the end of aisles extending to the fascia shall be not less than 1100 mm high for the width of the aisle or 1.2 m high at the foot of steps.
- vii Cross-aisles, except where the backs of seats on the front of the aisle project 600 mm or more above the floor of the aisle, shall be provided with railings not less than 900 mm high.
- viii No turnstiles or other devices to restrict the movement of persons shall be installed in any place of assembly in such a manner as to interfere in any way with the required exit facilities.
- ix In theatres and similar places of public assembly where persons are admitted to the building at a time when seats are not available for them and are allowed to wait in a lobby or similar space until seats are available, such use of lobby or similar space shall not encroach upon the required clear width of exits. Such waiting shall be restricted to areas separated from the required exit ways by substantial permanent partitions or fixed rigid railing not less than 1050 mm high. Exits shall be provided for such waiting spaces on the basis of one person for each 0.3 m<sup>2</sup> of waiting space area. Such exits shall be in addition to the exits specified for the main auditorium area and shall conform in construction and arrangement to the general rules of exits given above.
- x No display or exhibit shall be so installed or operated as to interfere in any way with access to any required exit, or with any required exit sign.
- xi All displays or exhibits of combustible material or construction and all booths and temporary construction in connection therewith shall be so limited in combustibility or protected as to avoid any undue hazard of fire which might endanger occupants before they have opportunity to use the available exits, as determined by the authority.
- xii Places of assembly in buildings of other occupancy may use exits common to the place of assembly and the other occupancy, provided the assembly area and the other occupancy are considered separately, and each has exits sufficient to meet the requirements of the rules.
- xiii Exits shall be sufficient for simultaneous occupancy of both the places of assembly and other parts of the building.
- xiv For detailed information regarding cinema buildings, reference may be made to good practice (*Refer Annexure K (27)*).
- xv Seats in places of public assembly, accommodating more than 300 persons, shall be securely fastened to the floor, except as permitted in (xvi) below. All seats in balconies and galleries shall be securely fastened to the floor, except that in nailed-in enclosures, boxes with level floors and having not more than 14 seats, the seats need not be fastened.
- xvi Chairs not secured to the floor may be permitted in restaurants, night clubs and other occupancies where the fastening of seats to the floor may not be practicable, provided that in the area used for seating, excluding dance floor, stage, etc, there shall be not more than one seat for each 1.4 m<sup>2</sup> of floor area and adequate aisles to reach exits shall be maintained at all times. The arrangements shall be as follows in general:
  - Rows of seats between aisles shall have not more than 14 seats.
  - Rows of seats opening on to an aisle at one end only shall have not more than 7 seats.
  - Seats without dividing arms shall have their capacity determined by allowing 450 mm per person.
- xv The spacing of rows of seats from back to back shall be neither less than 850 mm nor less than 700 mm plus the sum of the thickness of the back and inclination of the back. There shall be a space of not less than 350 mm between the back of one seat and the front of the seat immediately behind it as measured between plumb lines.

- xvi Lighting: No open flame lighting devices shall be used in any place of assembly, except in the following cases:
    - Where necessary for ceremonial purposes, the enforcing Authority may permit open flame lighting under such restrictions as are necessary to avoid danger of ignition of combustible materials or injury to occupants.
    - Candles may be used on restaurant tables if securely supported on non-combustible bases and so located as to avoid danger of ignition of combustible materials.
    - Open flame devices may be used on stages where they are a necessary part of theatrical performance, provided adequate precautions, satisfactory to the Authority are taken to prevent ignition of combustible materials.
- b) Fire Protection
- i Every stage equipped with fly galleries, grid irons and rigging for movable theatre type scenery, shall have a system of automatic sprinklers over and under such stage areas or spaces and auxiliary spaces, such as dressing rooms, storerooms and workshops, and the proscenium opening shall be provided with a fire resisting curtain, capable of withstanding a lateral pressure of 4 k N/m<sup>2</sup> over the entire area. The curtain shall have an emergency closing device capable of causing the curtain to close without the use of power and when so closed, it shall be reasonably tight against the passage of smoke.
  - ii The stage roof of every theatre using movable scenery or having a motion picture screen of highly combustible construction shall have a ventilator or ventilators in or above it, openable from the stage floor by hand and also opening by fusible links or some other approved automatic heat/smoke actuated device, to give a free opening equal to at least one-eighth the area of the floor of the stage.
  - iii The proscenium wall of every theatre using movable scenery of decorations shall have, exclusive of the proscenium opening, not more than two openings entering the stage, each not to exceed 2 m<sup>2</sup> and fitted with self-closing fire-resistant doors.
  - iv Every place of assembly in which projection of motion pictures by light is made shall have the projection apparatus enclosed in a fire resisting fixed booth in accordance with good practice (*Refer Annexure K (27)*), except that such booth shall not be required where no nitrocellulose motion picture film is used.

#### 14.5.6 Transportation (Group F)

- 1 Fire Prevention
  - a) Subdivision F-1
 

The following shall be applicable:

    - i Decorations of places of assembly shall be of non-flammable materials. Fabrics and papers used for such purpose shall be treated with an effective flame-retardant material. Stage settings made of combustible materials shall likewise be treated with fire retardant materials of Class 1 flame spread.
- 2 Life Safety
  - a) Subdivision F-1
 

The following shall be applicable:

    - i Exit door width for assembly buildings shall not be less than 2.0 m.
    - ii Clear aisles not less than 1.2 m in width shall be formed at right angles to the line of seating in such number and manner that no seat shall be more than seven seats away from an aisle. Rows of seats opening on to an aisle at one end only shall have not more than seven seats.
    - iii Under the conditions, where all these aisles do not directly meet the exit doors, cross-aisles shall be provided parallel to the line of seating so as to provide direct access to the exit, provided that not less than one cross aisle for every 10 rows shall be

- required. The width of cross-aisles shall be minimum of 1 m. Steps shall not be placed in aisles to overcome differences in levels, unless the gradient exceeds 1 in 10.
- iv The fascia of boxes, balconies and galleries shall have substantial railings not less than 1000 mm high above the floor. The railings at the end of aisles extending to the fascia shall be not less than 1100 mm high for the width of the aisle or 1.2 m high at the foot of steps.
  - v Cross-aisles, except where the backs of seats on the front of the aisle project 600 mm or more above the floor of the aisle, shall be provided with railings not less than 900 mm high.
  - vi No turnstiles or other devices to restrict the movement of persons shall be installed in any place of assembly in such a manner as to interfere in any way with the required exit facilities.
  - vii In theatres and similar places of public assembly where persons are admitted to the building at a time when seats are not available for them and are allowed to wait in a lobby or similar space until seats are available, such use of lobby or similar space shall not encroach upon the required clear width of exits. Such waiting shall be restricted to areas separated from the required exit ways by substantial permanent partitions or fixed rigid railing not less than 1050 mm high. Exits shall be provided for such waiting spaces on the basis of one person for each 0.3 m<sup>2</sup> of waiting space area. Such exits shall be in addition to the exits specified for the main auditorium area and shall conform in construction and arrangement to the general rules of exits given above.
  - viii No display or exhibit shall be so installed or operated as to interfere in any way with access to any required exit, or with any required exit sign.
  - ix All displays or exhibits of combustible material or construction and all booths and temporary construction in connection therewith shall be so limited in combustibility or protected as to avoid any undue hazard of fire which might endanger occupants before they have opportunity to use the available exits, as determined by the authority.
  - x Places of assembly in buildings of other occupancy may use exits common to the place of assembly and the other occupancy, provided the assembly area and the other occupancy are considered separately, and each has exits sufficient to meet the requirements of the rules.
  - xi Exits shall be sufficient for simultaneous occupancy of both the places of assembly and other parts of the building.
  - xii For detailed information regarding cinema buildings, reference may be made to good practice (*Refer Annexure K (27)*).
  - xiii Seats in places of public assembly, accommodating more than 300 persons, shall be securely fastened to the floor, except as permitted in (r) below. All seats in balconies and galleries shall be securely fastened to the floor, except that in nailed-in enclosures, boxes with level floors and having not more than 14 seats, the seats need not be fastened.
  - xvi Chairs not secured to the floor may be permitted in restaurants, night clubs and other occupancies where the fastening of seats to the floor may not be practicable, provided that in the area used for seating, excluding dance floor, stage, etc, there shall be not more than one seat for each 1.4 m<sup>2</sup> of floor area and adequate aisles to reach exits shall be maintained at all times. The arrangements shall be as follows in general:
    - Rows of seats between aisles shall have not more than 14 seats.
    - Rows of seats opening on to an aisle at one end only shall have not more than 7 seats.
    - Seats without dividing arms shall have their capacity determined by allowing 450 mm per person.
  - xv The spacing of rows of seats from back to back shall be neither less than 850 mm nor less than 700 mm plus the sum of the thickness of the back and inclination of the back. There shall be a space of not less than 350 mm between the back of one seat and the front of the seat immediately behind it as measured between plumb lines.

- xvi Lighting: No open flame lighting devices shall be used in any place of assembly, except in the following cases:
- Where necessary for ceremonial purposes, the enforcing Authority may permit open flame lighting under such restrictions as are necessary to avoid danger of ignition of combustible materials or injury to occupants.
  - Candles may be used on restaurant tables if securely supported on non-combustible bases and so located as to avoid danger of ignition of combustible materials.
  - Open flame devices may be used on stages where they are a necessary part of theatrical performance, provided adequate precautions, satisfactory to the Authority are taken to prevent ignition of combustible materials.
- b) Subdivision F-2
- i) Every area used for the storage of hazardous commodities shall have an exit within 22.5 m of any point in the area where persons may be present or 35 m where automatic sprinkler protection is provided.
  - ii) Every storage area or space exceeding 1400 m<sup>2</sup> gross area, or where more than 10 persons may be normally present shall have at least two exit access doors leading to the corridors in exit access, which can be readily opened. This shall not be subject to locking so long as any persons are inside and shall not depend on power operation. Exits in such cases shall be as remote from each other as practicable. For warehouses, natural draft smoke venting shall utilize roof vents or vents in walls at or near the ceiling level; such vents shall be normally open, or, if closed, shall be designed for automatic opening in case of fire, by release of smoke sensitive devices.
  - iii) The following special provisions shall apply to aircraft hangers:
    - Exits from aircraft hangers (storage or servicing areas) shall be provided at intervals of not more than 45 m on all exterior walls of aircraft hangers. There shall be a minimum of two exits serving each aircraft storage or servicing areas. Horizontal exits through interior fire walls shall be provided at intervals of not more than 30 m. ‘Dwarf’ or ‘smash’ doors accommodating aircraft may be used to comply with these requirements. All doors designated as exits shall be kept unlocked in the direction of exit travel while the area is occupied.
    - Exits from mezzanine floors in aircraft storage or servicing areas shall be so arranged that the maximum travel to reach the nearest exits from any point on the mezzanine shall not exceed 22.5 m. Such exits shall lead directly to a properly enclosed stairwell discharging directly to the exterior or to a suitably cut-off area or to outside fire escape stairs.
  - iv) The following special provisions shall apply to grain elevators:
    - There shall be at least one stair tower from basement to first floor and from the first floor to the top floor of workhouse which is enclosed in a dust tight non-combustible shaft.
    - Non-combustible doors of self-closing type shall be provided at each floor landing.
    - An exterior fire escape of the stair or basket ladder type shall be provided from the roof of the workshop to ground level or the roof of an adjoining annexe with access from all floors above the first.
    - An exterior fire escape of either the stair or basket ladder type shall be provided from the roof of each storage annexe to ground level.
  - v) For provisions relating to car parking facilities, see Annexure H.
- 2 Additional Precautions  
Requirements specified in Additional precautions for Group J shall apply to Group G occupancies also.

### **14.5.7 Storage Buildings (Group G)**

#### **1 Life Safety**

- a) Every area used for the storage of hazardous commodities shall have an exit within 22.5 m of any point in the area where persons may be present or 35 m where automatic sprinkler protection is provided.
- b) Every storage area or space exceeding 1400 m<sup>2</sup> gross area, or where more than 10 persons may be normally present shall have at least two exit access doors leading to the corridors in exit access, which can be readily opened. This shall not be subject to locking so long as any persons are inside and shall not depend on power operation. Exits in such cases shall be as remote from each other as practicable.

For warehouses, natural draft smoke venting shall utilize roof vents or vents in walls at or near the ceiling level; such vents shall be normally open, or, if closed, shall be designed for automatic opening in case of fire, by release of smoke sensitive devices.

- c) The following special provisions shall apply to aircraft hangers:
  - i Exits from aircraft hangers (storage or servicing areas) shall be provided at intervals of not more than 45 m on all exterior walls of aircraft hangers. There shall be a minimum of two exits serving each aircraft storage or servicing areas. Horizontal exits through interior fire walls shall be provided at intervals of not more than 30 m. 'Dwarf' or 'smash' doors accommodating aircraft may be used to comply with these requirements. All doors designated as exits shall be kept unlocked in the direction of exit travel while the area is occupied.
  - ii Exits from mezzanine floors in aircraft storage or servicing areas shall be so arranged that the maximum travel to reach the nearest exits from any point on the mezzanine shall not exceed 22.5 m. Such exits shall lead directly to a properly enclosed stairwell discharging directly to the exterior or to a suitably cut-off area or to outside fire escape stairs.
- d) The following special provisions shall apply to grain elevators:
  - i There shall be at least one stair tower from basement to first floor and from the first floor to the top floor of workhouse which is enclosed in a dust tight non-combustible shaft.
  - ii Non-combustible doors of self-closing type shall be provided at each floor landing.
  - iii An exterior fire escape of the stair or basket ladder type shall be provided from the roof of the workshop to ground level or the roof of an adjoining annexe with access from all floors above the first.
  - iv An exterior fire escape of either the stair or basket ladder type shall be provided from the roof of each storage annexe to ground level.
- e) For provisions relating to car parking facilities, see Annex H.

#### **2 Additional Precautions**

- a) In any room in which volatile flammable substances are used or stored, no device generating a glow or flame capable of igniting flammable vapour shall be installed or used, such a room shall be provided with a suitably designed exhaust ventilation system (see Annexure M).

### **14.5.8 Mercantile Buildings (Group H)**

#### **1 Life Safety**

- a) Not less than two exits shall be provided for every floor, including basements occupied for office purposes or uses incidental thereto.
- b) Open air mercantile operations, such as open air markets, petrol filling stations, roadside stands for the sale of a farm produce and other outdoor mercantile operations shall be so arranged and conducted as to maintain free and unobstructed ways of travel at all times to permit prompt escape from any point of danger in case of fire or other emergency, but no dead-ends in which persons might be trapped due to display stands, adjoining buildings, fences, vehicles or other obstructions.

- c) If such mercantile operations are conducted in roofed-over areas, these shall be treated as mercantile buildings, provided canopies over individual small stands to protect merchandise from the weather shall not be construed to constitute buildings for the purpose of the Rules.
- d) Life Safety provisions for H-2 Occupancy
  - The following additional requirements shall be applicable:
    - i Assembly occupancies of theatres, cinema halls and multiplexes shall be so located in the mall building that their exits will be separate and lead the occupant directly to exit discharge.
    - ii The common path of travel shall be 30 m. The maximum dead end of corridor distance shall not exceed 6 m.
    - iii The minimum width of an exit passageway shall be 2.0 m.
    - iv Where wheeled carts or buggies are used by customers, adequate provision shall be made for the transit and parking of such carts to minimise the possibility that they might obstruct means of egress. Any other storage or hindrances causing obstruction in exits shall be avoided.
    - v Car parking facilities shall comply with Annexure H. Car parking areas at upper levels adjacent to shops, food courts or multiplex shall be separated by 120 min fire rated construction and building elements.
    - vi 50 percent lifts in common areas in H-2 shall be with features and requirement of fireman's lift.
    - vii The manual call points shall be break glass and not pull stations.
    - viii Photoluminescent markings shall be done along the width and length of treads in all enclosed exits staircases. Exit directional arrow on the wall (in the direction of egress) shall be 175 mm × 50 mm.
    - ix Refuge area to be provided on the floor at or immediately above 18 m shall be not less than 10 percent of gross area of floor. Next refuge area to be at/on the floor immediately above 24 m. The refuge area shall be 10 percent of the respective floor, which may be divided into two or more separate refuge areas at each of the respective floors, with each being not less than 100 m<sup>2</sup>. Refuge area shall also meet all the requirements of life safety as per Rule No. 14.3.
- 2 Fire Prevention
  - a) Additional fire prevention requirements for H-2 occupancy
    - Building having H-2 mixed use assembly/mercantile occupancy will limit the height of the assembly/mercantile occupancy portion of the buildings to 30 m. Above this height the buildings may be used for business or residential occupancies with 240 min separation. Independent exits shall be provided for such occupancy above 30 m and shall not interface with exits of assembly/mercantile occupancy.
- 3 Exception and Deviation
  - Any mercantile occupancy, where goods of a highly hazardous nature are predominant, shall be considered under Group J occupancy for the purpose of the Rules.

#### **14.5.9 Business Buildings (Group I)**

- 1 Life Safety
  - Not less than two exits shall be provided for every floor, including basements occupied for office purposes or uses incidental thereto.
- 2 Fire Protection
  - a) For Subdivision E-2, the requirement shall be provision of automatic fire detection alarm system, while for fire protection, CO<sub>2</sub> and/or foam-based installation to be planned based on the requirements.
  - b) For Subdivision E-3, E-4 and E-5, the requirement shall be provision of automatic fire detection alarm system, while for fire protection, any or combination of clean agents, mist technologies, hypoxic air technology, etc, may be planned for appropriate/special

situations/locations. Electrical panels may be provided with CO<sub>2</sub>/inert gas flooding system based on the requirement and reliability of power for the functional requirement and performance.

#### **14.5.10 Industrial Buildings (Group J)**

##### **1 Fire Prevention**

###### **a) Fire separating walls, fire separating floors and fire partitions**

Fire separating walls shall be provided between two buildings or between two blocks inside a building, having different fire hazards in accordance with the provisions of this Part. The areas having storage, manufacturing, hazardous activities such as paint store, oil storage, spray booths, etc, shall be separated from non-hazardous areas like administrative office, staff canteen, etc by fire rated walls/doors of 120 min fire resistance rating. The fire resistance rating of high hazardous areas like petrochemical, explosives shall be 240 min.

The fire separating wall where provided shall comply with the following requirements:

- i The separating wall shall be carried through the roof. This portion of the wall extending above the roof, known as 'screen wall' shall be of such a height (in no case less than 600 mm) that the horizontal distance at the level of the top of the screen wall between the roofs of the buildings/compartments being segregated is at least 6 m.
- ii The screen wall shall be of not less than 230 mm in thickness if it is an extension of a masonry wall, and not less than 150 mm in thickness if it is an extension of a reinforced concrete wall.
- iii The separating wall need not be extended as a screen wall if the roof of one or both of the buildings/blocks being segregated is of reinforced concrete construction (RCC).
- iv In the case of buildings of unequal height, windows or other openings in the wall of the higher building overlooking the roof of the lower building and within 6 m, thereof, shall be protected by fire resistant glass assembly or by approved type fire doors unless the roof of the lower building is of reinforced concrete.
- v In case the eaves of the higher building fall within 6 m of the roof of the lower building such eaves should be cut-off and the screen wall raised as a parapet, 600 mm high over the roof of the higher building, unless the roof of the lower building is of RCC construction.
- vi Fire separating walls shall also be extended outwards on both sides by at least 450 mm.
- vii Doors and window openings in external walls within 3 m of the fire separating walls shall be protected by fire doors having a rating of at least 60 min and window openings may be protected by fire resistant glass assembly having same fire rating.
- viii In the case of buildings/compartments having north-light roofs when a separating wall runs parallel to the axis of the north-light opening, the screen wall shall be carried through and 600 mm above the ridge of the north light. If, however, the separating wall is at right angles to the axis of the north-light opening, the saw tooth gaps shall be bricked up and the screen wall extended 600 mm above the ridge of the north light as well as beyond the extreme north-light opening.
- ix Similarly, the thickness of the floor slabs in case of buildings having upper levels shall be designed to provide fire rating as mentioned above.
- x Storage areas shall be separated from the remainder of the building/block by fire walls.
- xi Moderate and high hazard areas in industries to have two fire doors each having 180 min fire resistance rating.

##### **2 Life Safety**

- a) In buildings used for aircraft assembly or other occupancy requiring undivided floor areas so large that the distances from points within the area to the nearest outside walls where exit doors could be provided are in excess of 45 m, requirements for distance to exits may be satisfied by providing stairs leading to exit tunnels or to overhead passageways. In cases

where such arrangements are not practicable, the Authority may, by special ruling, permit other exit arrangements for single storeyed buildings with distances in excess of the maximum distances specified in 4, if completely automatic sprinkler protection is provided and if the heights of ceiling curtain boards and roof ventilation are such as to minimise the possibility that employees will be overtaken by the spread of fire or smoke within 1.8 m of the floor level before they have time to reach exits, provided, however, that in no case may the distance of travel to reach the nearest exit exceed 65 m where smoke venting is required as a condition for permitting distances of travel to exits in excess of the maximum otherwise allowed.

- b) The following shall apply to special purpose industrial occupancies:
  - i Exits need be provided only for the persons actually employed; spaces not subject to human occupancy because of the presence of machinery or equipment may be excluded from consideration.
  - ii Where unprotected vertical openings are necessary to manufacturing operations, these may be permitted beyond the limits specified for industrial occupancy, provided every floor level has direct access to one or more enclosed stairways or other exits protected against obstruction by any fire in the open areas connected by the unprotected vertical openings or smoke therefrom.
- c) The following shall apply to high hazard industrial occupancies<sup>11</sup>:
  - i From every point in every floor area, there shall be at least two exits accessible in different directions; where floor areas are divided into rooms, there shall be at least two ways of escape from every room, however small rooms, except toilet rooms, so located that the points of access thereto are out of or suitably shielded from areas of high hazard.
  - ii In addition to types of exits for upper floors specified for Group J occupancies, slide escapes may be used as required exits for both new and existing buildings.

### 3 Additional Precautions

- a) In any room in which volatile flammable substances are used or stored, no device generating a glow or flame capable of igniting flammable vapour shall be installed or used, such a room shall be provided with a suitably designed exhaust ventilation system (see Annexure J).
- b) For detailed information on fire safety of certain individual (specific) industrial occupancies, reference may be made to good practice (*Refer Annexure K (28)*)
- c) Fire protection considerations for venting industrial occupancies shall be as in Annexure J.

---

<sup>11</sup> NOTE — All high hazard industrial occupancies shall have automatic sprinkler protection, or such other protection as may be appropriate to the particular hazard, including explosion venting for any area subject to explosion hazard, designed to minimise danger to occupants in case of fire or other emergency before they have time to utilize exits to escape.



## **ANNEXURES**

Annexure A:	Calorific Value of Common Materials
Annexure B:	Broad Classification of Industrial Occupancies into different Degree of Hazard
Annexure C:	Available Data regarding fire resistance rating of various Building Components
Annexure D:	Guidelines for Fire Drill and Evacuation for High Rise Buildings
Annexure E:	Additional Requirements for High Rise Buildings
Annexure F:	Atrium
Annexure G:	Commercial Kitchens
Annexure H:	Car Parking Facilities
Annexure J:	Fire Protection Considerations for Venting in Industrial Buildings
Annexure K:	List of Standards

## **List of Tables**

- Table No. AA-1: Calorific Values of Common Materials
- Table No. AB-1: Classification of Industries as per Degree of Hazard
- Table No. AC-1: Masonry Walls: Solid (Required to Resist Fire from One Side at a Time)
- Table No. AC-2: Masonry Walls: Hollow (Required to Resist Fire from One Side at a Time)
- Table No. AC-3: Framed Construction, Load Bearing (Required to Resist Fire from One Side at a Time)
- Table No. AC-4: Framed Construction, Non Load Bearing (Required to Resist Fire from One Side at a Time)
- Table No. AC-5: Framed External Walls Load Bearing (Required to Resist Fire from One Side at a Time)
- Table No. AC-6: Framed External Walls Non-Load Bearing [Required to Resist Fire from Inside the Building (A)]
- Table No. AC-7: Framed External Walls Non-Load Bearing [Required to Resist Fire from Inside the Building (B)]
- Table No. AC-8: Framed External Walls Non-Load Bearing [Required to Resist Fire from Inside the Building (C)]
- Table No. AC-9: Reinforced Concrete Columns
- Table No. AC-10: Concrete Beams
- Table No. AC-11: Concrete Floors
- Table No. AC-12: Concrete Floors: Ribbed Open Soffit
- Table No. AC-13: Encased Steel Columns, 203 mm x 203 mm
- Table No. AC-14: Encased Steel Beams, 406 mm x 176 mm (Protection Applied on Three Sides)
- Table No. AC-15: Timber Floors – Tongued and Grooved Boarding, or Sheets of Tongued and Grooved Plywood or Wood Chipboard, of not Less than 21 mm Finished Thickness
- Table No. AC-16: Timber Floors – Tongued and Grooved Boarding, or Sheets of Tongued and Grooved Plywood or Wood Chipboard, of not Less than 15 mm Finished Thickness
- Table No. AC-17: Timber Floors – Any Structurally suitable flooring of Timber or Lignocellulose Boards
- Table No. AK-1 –: List of IS Codes and Titles

## **List of Figures**

- Figure No. AF-1: Sprinkler protection of glass for floor open to Atrium

## ANNEXURE A

### CALORIFIC VALUES OF COMMON MATERIALS

**A-1** The calorific values of some common materials are given in Table No AA-1 for guidance.

Table No AA-1 : Calorific Values of Common Materials

No	Material	Calorific Value ( x 10 <sup>3</sup> kJ/ Kg ) <sup>1)</sup>	Wood Equivalent (kg/kg)
(1)	(2)	(3)	(4)
i)	Solid Fuels		
	a) anthracite	28.6	1.66
	b) Bituminous coal	30.8	1.75
	c) Charcoal	28.4	1.61
	d) Coke (average)	27.5	1.56
	e) Peat	20.9	1.19
	f) Sub-Bituminous coil	22.0	1.25
	g) Woods (hard or softwood)	17.6	1.00
ii)	Hydrocarbons		
	a) Benzene	39.6	2.25
	b) Butane	47.1	2.68
	c) Ethane	49.1	2.79
	d) Ethylene	47.7	2.71
	e) Fuel oil	41.6	2.36
	f) Gas oil	42.9	2.44
	g) Hexane	44.9	2.55
	h) Methane (natural gas)	52.8	3.00
	i) Octane	45.3	2.58
	j) Paraffin	39.6-44.0	2.3-2.5
	k) Pentane	46.0	2.61
	l) Propane	47.3	2.69
	m) Propylene	46.2	2.63
iii)	Alcohols		
	a) Ethyl Alcohol	28.4	1.61
	b) Methyl Alcohol	21.1	1.20
	c) Propyl Alcohol	31.9	1.81
iv)	Polymers		
	a) Casein	23.1	1.31
	b) Cellulose	16.5	0.94
	c) Cellulose acetate	17.8	1.01
	d) Polyethylene	48.4	2.75
	e) Polystyrene	48.4	2.75
	f) Polyvinylchloride	41.8	2.38
	h) Polymethyl methacrylate	24.6	1.40
	j) Polyurethane	35.2	2.00
	k) Polyamide (nylon)	22.0	1.25
	m) Polyester	22.0	1.25
v)	Common Solids		
	a) Asphalt	38.3	2.13
	b) Bitumen	33.4	1.90
	c) Carbon	32.1	1.83
	d) Cotton (dry)	15.8	0.90
	e) Flax	14.3	0.81
	f) Furs and skins	18.7	1.06
	g) hair (animal)	20.9	1.19
	h) Leather	17.6	1.00

No	Material	Calorific Value ( x 10 <sup>3</sup> kJ/ Kg ) <sup>1)</sup>	Wood Equivalent (kg/kg)
(1)	(2)	(3)	(4)
	j) Ozokerite (wax)	43.1	2.46
	k) Paper (average)	15.4	0.88
	m) Paraffin wax	40.9	2.31
	n) Pitch	33.0	1.88
	p) Rubber	37.4	2.13
	q) Straw	13.2	0.75
	r) Tallows	37.6	2.14
	s) Tan bark	20.9	1.19
	t) Tar (bituminous)	35.2	2.00
	u) Wool (raw)	21.6	1.21
	w) Wool (scoured)	19.6	1.11
vi)	Foodstuffs		
	a) Barley	14.1	0.80
	b) Bran	11.0	0.63
	c) Bread	9.9	0.56
	d) Butter	29.5	1.68
	e) Cheese (cheddar)	18.1	1.03
	f) Corn meal	14.1	0.80
	g) Flour	14.1	0.80
	h) Margarine	29.5	1.68
	i) Oatmeal	15.8	0.90
	j) Rice	13.9	0.79
	k) Soya been flour	16.1	0.91
	l) Sugar	15.4	0.88
	m) Whole wheat	14.3	0.81
vii)	Miscellaneous		
	a) Acetone	29.7	1.69
	b) Acetaldehyde	25.1	1.43
	c) Formaldehyde	17.6	1.00
	d) Hydrogen	134.2	7.61
	e) Magnesium	24.0	1.36
Note:			
1) 1 kJ is approximately equal to 1 Btu so the figures in the tables are also equivalent to Btu/kg			

## ANNEXURE B

### BROAD CLASSIFICATION OF INDUSTRIAL OCCUPANCIES INTO DIFFERENT DEGREE OF HAZARD

Table No. AB-1 Classification of Industries as per Degree of Hazard

Light Hazard	Moderate Hazard	High Hazard
Abrasive Manufacturing Premises	Aluminium Factories	<b>Sub-Category (A)</b>
Aerated Water Factories	<i>Atta</i> and Cereal Grinding	Aircraft Hangers
<i>Agarbatti</i> Manufacturing	Bakeries and Biscuit Factories	Aluminium/Magnesium Powder Plants
Areca Nut Slicing and/or Betel nut Factories	<i>Beedi</i> Factories	Bituminised Paper and/or Hessian Cloth/Tar Felt Manufacturing
Analytical and/or Quality Control Laboratories	Bobbin Factories	Cotton Waste Factories
Asbestos Steam Packing and Lugging Manufacturing	Bookbinders, Envelopes and Paper Bag Manufacturing	Celluloid Goods Manufacturing
Battery Charging/Battery Service Stations	Cable Manufacturing	Chemical Manufacturing using raw materials having flash points below 23°C
Battery Manufacturing	Camphor Boiling	Cigarette Filter Manufacturing
Breweries	Candle Works	Cinema Films and T.V. Production Studios
Brick Works	Carbon Paper/Typewriter Ribbon Manufacturing	Coal and/or Coke and/or Charcoal Ball and Briquettes Manufacturing
Canning Factories	Cardboard Box Manufacturing	Collieries
Cardamom Factories	Carpenters, Wood Wool and Furniture Manufacturing	Cotton Seed Cleaning or De-linting Factories.
Cement Factories and/or Asbestos or Concrete Products Manufacturing	Carpet and Durries Factories	Distilleries
Ceramic Factories and Crockery and Stoneware Pipe Manufacturing	Cashewnut Factories	Duplicating/Stencil Paper Manufacturing
Clay Works	Chemical Manufacturing using raw materials having flash points above 23°C	Fire-works Manufacturing
Clock and Watch Manufacturing	Cigar and Cigarette Factories	Foam Plastics Manufacturing and/or Converting Plants.
Coffee Curing Roasting and Grinding Premises	Coir Factories	Godowns and Warehouses (Storing Combustible/Flammable Goods)
Condensed Milk Factories, Milk Pasteurising Plant and Dairies	Coir Carpets, Rugs, Tobacco, Hides and Skin Presses	Grass, Hay, Fodder and <i>Bhoosa</i> (chaff) Pressing Factories
Confectionery Manufacturing	Cold Storage Premises	Industrial Gas Manufacturing (Other than Inert/Halogenated Hydrocarbon Gases)
Electric Generating Houses (Hydro electric)	Cork Products Manufacturing	Jute Mills and Jute Presses
Electric Lamps (Incandescent and Fluorescent) and TV Picture Tube Manufacturing	Dry Cleaning, Dyeing and Laundries.	Linoleum Factories LPG Bottling Plants (Mini)
Electro Plating Works	Electric Substations/Distribution	Man Made Fibres (Acrylic

	Stations	Fibres/yarn Manufacturing)
Engineering Workshops	Electric Generating Stations (Other than Underground Power houses)	Match Factories
Fruits and Vegetables	Enamelware Factories	Mattress and Pillow Making
Dehydrating and Drying Factories	Filter and Wax Paper Manufacturing	Metal or Tin Printers (where more than 50 Percent of floor area is occupied as Engineering Workshop; this may be taken as ordinary hazard risk)
Fruit Products and Condiment Factories	Flour Mills	Oil Mills
Glass and Glass Fibre Manufacturing	Garages	Oil Extraction Plants
Godowns and Warehouses Storing Non-combustible Goods only	Garment Makers	Oil Terminals/Depots handling flammable Liquids having flash point of 23° C and Below
Green Houses	Ghee Factories (Other than Vegetable)	Paints and Varnish Factories
Gold Thread/Gilding Factories	Godowns and Warehouses (Other than those Under Light and High A Categories)	Paper and Cardboard Mills having raw material yards
Gum and/or Glue and Gelatine Manufacturing	Grain or seed Disintegrating and/or Crushing Factories	Piers, Wharves and Jetties — Handling Extra Hazardous Materials
Ice, Ice Candy and Ice-cream Manufacturing	Grease Manufacturing	Printing Ink Manufacturing.
Ink (Excluding Printing Ink) Factories	Hosiery, Lace, Embroidery and Thread Factories	Rosin Lamp-Black and Turpentine Factories
Mica Products Manufacturing	Incandescent Gas Mantle Manufacturing	Saw Mills
Pottery Works	Industrial Gas Manufacturing (Inert/Halogenated hydrocarbon gases)	Sponge Iron Steel Plants (Gas Based)
Poultry Farms	Man-made Yarn/Fibre Manufacturing (Other than Acrylic Fibres/Yarn Manufacturing )	Surgical Cotton Manufacturing
Salt Crushing Factories and Refineries	Manure and Fertilizer Works (Blending, Mixing and granulating)	Tarpaulin and Canvas Proofing Factories
Stables	Mineral Oil Blending and Processing	Turpentine and Rosin Distilleries
Sugar Candy Manufacturing	Oil and Leather Cloth Factories	Tyre Re treading and Resoling Factories
Sugar Factories and Refineries	Oil Terminals/Depots Other than those Categorized under High Hazard A	
Tanneries/Leather Goods Manufacturers	Open storage of Flammable Liquids in Drums, Cans, etc	<b>SUB-CATEGORY (B)</b>
Umbrella Assembling Factories	Oxygen Plants	Ammonia and Urea Synthesis Plants
Vermicelli Factories	Paper and Cardboard Mills. without Raw Material Yards Piers, Wharves, Jetties and Dockyards other than those Categorized Under High Hazard A	CNG Compressing and Bottling Plants
Water Treatment/Filtration Plants and Water Pump Houses	Plastic Goods Manufacturing	Coal Based Methane Plants
Zinc/Copper Factories	Plywood/Wood Veneering Factories	Explosive Factories

	Printing Press Premises	
	Pulverising and Crushing Mills	
	Rice Mills	
	Rope Works	
	Rubber Goods Manufacturing	
	Rubber Tyres and Tubes Manufacturing	
	Shellac Factories	
	Silk Filiatures	
	Soaps and Glycerine Factories	
	Spray Painting	
	Starch Factories	
	Tea Factories	
	Textile Mills	
	Tobacco (Chewing) and Pan-Masala Making	
	Tobacco Grinding and Crushing	
	Tobacco Redrying Factories	
	Woollen Mills	
Note –		
1) Any occupancy that is not covered in this Annexure shall be classified in the most appropriate class which resembles the proposed occupancy		
2) In case of complexes having separate plants having varying degrees of hazard, authority having jurisdiction shall be consulted to decide on level of protection to be provided.		



## ANNEXURE C

### AVAILABLE DATA REGARDING FIRE RESISTANCE RATING OF VARIOUS BUILDING COMPONENTS

Table No. AC-1 Masonry Walls: Solid (Required to Resist Fire from One Side at a Time)

No.	Nature of Construction and Materials	Minimum Thickness (mm), Excluding any Finish for a Fire Resistance (min) of										
		Load Bearing					Non-load bearing					
		60	90	120	180	240	60	90	120	180	240	
(1)	(2)	(3)	(4)	(5)	(6)	(7)	(8)	(9)	(10)	(11)	(12)	
i)	Reinforced cement concrete <sup>1)</sup>	120 (25) <sup>2</sup>	140 (25) <sup>2</sup>	160 (25) <sup>2</sup>	200 (25) <sup>2</sup>	240 (25) <sup>2</sup>	—	—	—	—	—	
ii)	Unreinforced cement concrete	150	175	—	—	—	—	—	—	—	—	
iii)	No-fines concrete with:											
	a)	13 mm cement/sand or gypsum/sand	—	—	—	—	—	150	150	150	150	150
	b)	13 mm light weight aggregate gypsum plaster	—	—	—	—	—	150	150	150	150	150
iv)	Bricks of clay:											
	a)	Without finish	90	100	100	170	170	75	90	100	170	170
	b)	With 13 mm lightweight aggregate plaster	90	90	90	100	100	75	90	90	90	100
v)	Bricks of sand lime:											
	a)	Without finish	90	100	100	190	190	75	90	100	170	170
	b)	With 13 mm lightweight aggregate plaster	90	90	90	100	100	75	90	90	90	100
vi)	Blocks of concrete:											
	a)	Without finish	90	100	100	—	—	75	90	100	140	150
	b)	With 13 mm lightweight aggregate gypsum plaster	90	90	90	100	100	75	75	75	90	100
	c)	With 13 mm cement/sand or gypsum/sand	—	—	—	—	—	75	90	90	100	140
vii)	Blocks of lightweight concrete:											
	a)	Without finish	90	100	100	140	150	75	75	75	125	140
	b)	With 13 mm lightweight aggregate plaster	90	90	90	100	100	50	63	75	75	75
	c)	With 13 mm cement/sand or gypsum/sand	—	—	—	—	—	75	75	75	90	100
viii)	Blocks of aerated concrete:											
	a)	Without finish	90	100	100	140	180	50	63	63	75	100
	b)	With 13 mm lightweight aggregate plaster	90	90	100	100	150	—	—	—	—	—

Note:  
<sup>1)</sup> Walls containing at least 1 percent of vertical reinforcement  
<sup>2)</sup> Minimum thickness of actual cover to reinforcement

Table No. AC-2 : Masonry Walls: Hollow (Required to Resist Fire from One Side at a Time)

No	Nature of Construction and Materials	Minimum Thickness (mm), Excluding any Finish for a Fire Resistance (min) of											
		Load Bearing					Non-load bearing						
		60	90	120	180	240	30	60	90	120	180	240	
(1)	(2)	(3)	(4)	(5)	(6)	(7)	(8)	(9)	(10)	(11)	(12)	(13)	
i)	Bricks of clay:												
	a) Without finish	170	170	170	200	200	75	75	90	100	170	170	
	b) With 13 mm lightweight aggregate plaster	100	100	170	170	170	75	75	90	90	90	100	
ii)	Blocks of concrete:												
	a) Without finish	—	—	—	—	—	90	125	125	140	140	150	
	b) With 13 mm cement/sand or gypsum/sand	—	—	—	—	—	90	125	125	140	140	140	
	c) With 13 mm lightweight aggregate gypsum plaster	190	200	200	—	—	75	90	90	100	125	125	
iii)	Blocks of lightweight concrete:												
	a) Without finish	100	100	100	—	—	75	90	90	100	140	150	
	b) With 13 mm cement/sand or gypsum/sand	—	—	—	—	—	75	75	75	100	140	140	
	c) With 13 mm lightweight aggregate gypsum plaster	—	—	—	—	—	63	63	63	75	90	100	

Table No. AC-3: Framed Construction, Load Bearing (Required to Resist Fire from One Side at a Time)

No.	Nature of Construction and Materials/Timber Studs at Centres not Exceeding 600 mm, Faced on Each Side With	Minimum Thickness (mm) of Protection for a fire Resistance of 60 min
(1)	(2)	(3)
i)	Plasterboard layers with joints staggered, joints in outer layer taped and filled -Total thickness for each face	25
ii)	One layer of 12.7 mm plasterboard with a finish of lightweight aggregate	13
iii)	Metal lath and plaster, thickness of plaster:	
	a) Sanded gypsum plaster (metal lathing grade)	22
	b) Lightweight aggregate gypsum plaster	13

**Table No. AC-4: Framed Construction, Non-Load Bearing (Required to Resist Fire from One Side at a Time)**

No	Stud Construction		Nature of Construction and Materials/Steel or Timber Frame at Centres not Exceeding 600 mm, Facing on Both Sides of	Minimum Thickness (mm) of Protection for a fire Resistance of			
				30 min	60 min	90 min	120 min
(1)	(2)		(3)	(4)	(5)	(6)	(7)
i)	Dry lining with materials fixed direct to studs, without plaster finish:						
	a)	One layer of plasterboard with taped and filled joints	Timber or steel	12.7	—	—	—
	b)	Two layers of plasterboard with joints staggered, joints in outer layer taped and filled — Total thickness for each face	Timber or steel	19	25	—	—
	c)	One layer of asbestos insulating board with transverse joints backed by fillers of asbestos insulating board not less than 9 mm thick, or by timber	Timber or steel	9	12	—	—
	d)	One layer of wood wool slabs Timber 25	Timber	25	—	—	—
	e)	One layer of chipboard or of plywood	Timber or steel	18	—	—	—
ii)	Lining with materials fixed direct to studs, with plaster finish:						
	a)	Plasterboard of thickness:					
	1)	With not less than 5 mm gypsum plaster finish	Timber or steel	9.5	—	—	—
2)	With not less than 13 mm gypsum plaster finish	Timber or steel	—	12.7	—	—	
iii)	Wet finish:						
	a)	Metal lath and plaster, thickness of plaster:					
	1)	Sanded gypsum plaster	Timber or steel	13	13	19	25
2)	Lightweight aggregate gypsum plaster	Timber or steel	—	13	—	—	

**Table No. AC-5: Framed External Walls Load Bearing (Required to Resist Fire from One Side at a Time)**

No	Nature of Construction and Materials	Minimum Thickness (mm) of Protection for a fire Resistance of 60 min
(1)	(2)	(3)
i)	Timber studs at centres not exceeding 600 mm with internal linings of: Plasterboard layers with joints in outer layer taped and filled, total thickness of plasterboard	31

**Table No. AC-6: Framed External Walls Non-Load Bearing [Required to Resist Fire from Inside the Building (A)]**

No.	Nature of Construction and Materials		Minimum Thickness (mm) of Protection for a fire Resistance of						
			30 min	60 min	90 min	120 min	180 min	240 min	
(1)	(2)		(3)	(4)	(5)	(6)	(7)	(8)	
i)	Steel frame with an external cladding of non-combustible sheets (excluding sheet steel), with a steel supporting framework and internal lining of:								
	a)	Metal lath and plaster, thickness of plaster:							
		1)	Sanded gypsum plaster (metal lathing grade)	13	13	—	—	—	—
		2)	Lightweight aggregate gypsum plaster	10	13	15	15	15	19
	b)	Two layer of plasterboard with joints staggered joints in outer layer taped and filled – Total thickness	21	32	—	—	—	—	
ii)	c) Plasterboard of thickness:								
	1)	With not less than 5 mm gypsum plaster finish	12.7	—	—	—	—	—	
	2)	With not less than 13 mm gypsum plaster finish	9.5	—	—	—	—	—	
	3)	With not less than 10 mm lightweight aggregate gypsum plaster	9.5	—	—	—	—	—	
	d)	One layer of asbestos insulating board with transverse joints backed by fillers of asbestos insulating board not less than 9 min thick, or by timber	9	9	12	12	12	12	
iii)	e) One layer of wood/wool slabs without finish		—	50	—	—	—	—	
	f)	One layer of compressed straw building slabs:							
		1)	Without finish	50	—	—	—	—	—
		2)	With not less than 5 mm gypsum plaster finish	—	50	—	—	—	—
	g)	Aerated concrete blocks	50	50	63	63	75	100	
	h)	Bricks of clay:							
1)		Without finish	75	75	90	90	100	100	
	2)	With not less than 13 mm lightweight aggregate gypsum plaster	—	—	75	75	90	90	

**Table No. AC-7: Framed External Walls Non-Load Bearing [Required to Resist Fire from Inside the Building (B)]**

No.	Nature of Construction and Materials	Minimum Thickness (mm) of Protection to provide Sufficient Insulation to achieve a Modified Fire Resistance of Upto 240 min
(1)	(2)	(3)
i)	Steel frame with an external cladding of sheet steel fully lapped, steel bolted and fixed to steel sheeting rails, with timber or steel supporting framework and internal lining of:	
a)	Metal lath and plaster, thickness of plaster:	
1)	Sanded gypsum plaster (metal lathing grade)	13
2)	Lightweight aggregate gypsum plaster	10
b)	One layer of plasterboard with joints taped and filled	12.7
c)	Plasterboard of thickness with not less than 5 mm gypsum plaster finish	9.5
d)	One layer of asbestos insulating board with transverse joints backed by fillers of asbestos insulating board not less than 9 mm thick, or by timber	9
e)	One layer of wood/wool slabs	25
f)	One layer of compressed straw building slabs	50
g)	One layer of chipboard or of plywood	18
h)	Aerated concrete blocks	50
j)	Bricks of clay	75
k)	Any internal decorative lining with a cavity fill independently supported and retained in position of mineral fibre insulating material (excluding glass) at a density of 48 kg/m <sup>3</sup>	50

**Table No. AC-8: Framed External Walls Non-Load Bearing [Required to Resist Fire from Inside the Building (C)]**

No	Nature of Construction and Materials	Minimum Thickness (mm) of Protection for a Fire Resistance of 90 min
(1)	(2)	(3)
i)	Timber frame with external cladding of weather boarding or external plywood, 9.5 mm with an internal lining of:	
a)	Plasterboard not less than 9.5 mm thick, finished with:	
1)	Gypsum plaster	13
2)	Lightweight aggregate gypsum plaster	10
b)	Plasterboard not less than 12.7 mm thick, finished with:	
1)	Gypsum plaster	10
2)	Lightweight aggregate gypsum plaster	10
c)	One layer of asbestos insulating board with transverse joints backed by fillers of asbestos insulating board not less than 9 mm thick.	9
	or by timber	12

Table No. AC-9: Reinforced Concrete Columns

No.	Nature of Construction and Materials		Minimum Dimensions (mm) of Protection for a fire Resistance of						
			30 min	60 min	90 min	120 min	180 min	240 min	
(1)	(2)		(3)	(4)	(5)	(6)	(7)	(8)	
i)	Fully exposed	a)	Width	150	200	250	300	400	450
		b)	Cover	40	40	40	40	40	40
ii)	50 percent exposed	a)	Width	125	160	200	200	300	350
		b)	Cover	40	40	40	40	40	40
iii)	One face exposed	a)	Thickness	100	120	140	160	200	240
		b)	Cover	40	40	40	40	40	40

Table No. AC-10: Concrete Beams

No	Nature of Construction and Materials		Minimum Dimensions (mm) of Protection for a fire Resistance of						
			30 min	60 min	90 min	120 min	180 min	240 min	
(1)	(2)		(3)	(4)	(5)	(6)	(7)	(8)	
i)	Reinforced concrete (simply supported)	a)	Width	200	200	200	200	240	280
		b)	Cover	20	20	20	40	60 <sup>1)</sup>	70 <sup>1)</sup>
ii)	Reinforced concrete (continuous)	a)	Width	200	200	200	200	240	280
		b)	Cover	20	20	20	30	40	50 <sup>1)</sup>
iii)	Prestressed concrete (simply supported)	a)	Width	100	120	150	200	240	280
		b)	Cover	25	40	55 <sup>1)</sup>	70	80 <sup>1)</sup>	90 <sup>1)</sup>
iv)	Prestressed concrete (continuous)	a)	Width	80	100	120	150	200	240
		b)	Cover	20	30	40	55 <sup>1)</sup>	70 <sup>1)</sup>	80 <sup>1)</sup>

<sup>1)</sup> Require attention to the additional measures necessary to reduce the risk of spalling.

Table No. AC-11: Concrete Floors

No.	Nature of Construction and Materials		Minimum Dimensions (mm) Excluding any Finish, for a Fire Resistance of						
			30 min	60 min	90 min	120 min	180 min	240 min	
(1)	(2)		(3)	(4)	(5)	(6)	(7)	(8)	
i)	Reinforced concrete (simply supported)	a)	Thickness	75	95	110	125	150	170
		b)	Cover	20	20	25	35	45 <sup>1)</sup>	55 <sup>1)</sup>
ii)	Reinforced concrete (continuous)	a)	Thickness	75	95	110	125	150	170
		b)	Cover	20	20	20	25	35	45 <sup>1)</sup>

<sup>1)</sup> Require attention to the additional measures necessary to reduce the risk of spalling

Table No. AC-12: Concrete Floors: Ribbed Open Soffit

No.	Nature of Construction and Materials		Minimum Dimensions (mm) Excluding any Finish, for a Fire Resistance of						
			30 min	60 min	90 min	120 min	180 min	240 min	
(1)	(2)		(3)	(4)	(5)	(6)	(7)	(8)	
i)	Reinforced concrete (simply supported)	a)	Thickness of floor	75	95	110	125	150	170
		b)	Rib width	125	125	125	125	150	175
		c)	Cover	20	20	35	45 <sup>1)</sup>	55 <sup>1)</sup>	65 <sup>1)</sup>
ii)	Reinforced concrete (continuous)	a)	Thickness of floor	75	95	110	125	150	170
		b)	Rib width	125	125	125	125	150	175
		c)	Cover	20	20	20	35	45 <sup>1)</sup>	55 <sup>1)</sup>

<sup>1)</sup> Require attention to the additional measures necessary to reduce the risk of spilling

Table No. AC-13: Encased Steel Columns, 203 mm x 203 mm

No.	Nature of Construction and Materials		Minimum Dimensions (mm) Excluding any Finish for a Fire Resistance of					
			60 min	90 min	120 min	180 min	240 min	
(1)	(2)		(3)	(4)	(5)	(6)	(7)	
i)	Hollow protection (without an air cavity over the flanges):							
	a)	Metal lathing with trowelled lightweight aggregate gypsum plaster <sup>1)</sup>	13	15	20	32	—	
	b)	Plasterboard with 1.6 mm wire binding at 100 mm pitch, finished with lightweight aggregate gypsum plaster not less than the thickness specified:						
		1)	9.5 mm plaster board	10	15	—	—	—
		2)	19 mm plaster board	10	13	20	—	—
	c)	Asbestos insulating boards, thickness of board:						
		1)	Single thickness of board, with 6 mm cover fillets at transverse joints	—	19	3.	—	—
	2)	Two layers, of total thickness	—	—	—	38	—	
	d)	Solid bricks of clay, composition or sand lime, reinforced in every horizontal joint, unplastered		50	50	50	75	100
	e)	Aerated concrete blocks		60	60	60	—	—
f)	Solid blocks of lightweight concrete hollow protection (with an air cavity over the flanges)		50	50	50	60	75	
ii)	Asbestos insulating board screwed to 25 mm asbestos battens		12	19	—	—	—	
iii)	Solid protections:							
	a)	Concrete, not leaner than 1:2:4 mix (unplastered):						
	1)	Concrete not assumed to be load bearing, reinforced)	25	25	25	50	75	
2)	Concrete assumed to be load bearing	50	50	50	75	75		

No.	Nature of Construction and Materials		Minimum Dimensions (mm) Excluding any Finish for a Fire Resistance of				
			60 min	90 min	120 min	180 min	240 min
(1)	(2)		(3)	(4)	(5)	(6)	(7)
	b)	Lightweight concrete, not leaner than 1:2:4 mix (unplastered): concrete not assumed to be load bearing, reinforced <sup>2)</sup>	25	25	25	40	60
<sup>1)</sup> So rued or designed, as to allow full penetration fin mechanical bond, <sup>2)</sup> Reinforcement shall consist of steel binding wire not less than 2.3 mm in thickness, or a steel mesh weighing not less than 0.5 kg/d. in concrete protection, the spacing of that reinforcement snail not exceed 200 mm in any direction.							



Table No. AC-14: Encased Steel Beams, 406 mm X 176 mm (Protection Applied on Three Sides)

No	Nature of Construction and Materials		Minimum Thickness (mm) of Protection for fire Resistance of						
			30 min	60 min	90 min	120 min	180 min	240 min	
(1)	(2)		(3)	(4)	(5)	(6)	(7)	(8)	
i)	Hollow protection (without an air cavity beneath the lower flange):								
	a)	Metal lathing with trowelled lightweight aggregate gypsum plaster <sup>1)</sup>	13	13	15	20	25	—	
	b)	Plasterboard with 1.6 mm wire binding <sup>2)</sup> at 100 mm pitch, finished with lightweight aggregate gypsum plaster not less than the thickness specified:							
		1)	9.5 mm plaster board	10	10	15	—	—	—
		2)	19 mm plaster board	10	10	13	20	—	—
	c)	Asbestos insulating boards, thickness of board:							
		1)	Single thickness of board, with 6 mm cover fillets at transverse joints	—	—	19	25	—	—
2)	Two layers of total thickness					38	50		
ii)	Hollow protection (with an air cavity below the lower flange):								
	a)	Asbestos insulating board screwed to 25 mm asbestos battens	9	12	—	—	—	—	
iii)	Solid protection:								
	a)	Concrete, not leaner than 1:2:4 mix (unplastered):							
	1)	Concrete not assumed to be load bearing, reinforced <sup>3)</sup>	25	25	25	25	50	75	
		Concrete assumed to be load bearing	50	50	50	50	75	75	
	b)	Lightweight concrete <sup>4)</sup> , not leaner than 1:2:4 (mix) unplastered	25	25	25	25	40	60	
<sup>1)</sup> So fixed or designed, as to allow full penetration for mechanical bond. <sup>2)</sup> Where wire binding cannot be used, expert advice should be sought regarding alternative methods of support to enable the lower edges of the plasterboard to be fixed together and to the lower flange, and for the top edge of the plasterboard to be held in position. <sup>3)</sup> Reinforcement shall consist of steel binding wire not less than 2.3 mm in thickness or a steel mesh weighing not less than 0.5 kg/m <sup>2</sup> . In concrete protection, the spacing of that reinforcement shall not exceed 200 mm in any direction. <sup>4)</sup> Concrete not assumed to be load bearing reinforced.									

Table No. AC-15: Timber Floors – Tongued and Grooved Boarding, or Sheets of Tongued and Grooved Plywood or Wood Chipboard, of not Less than 21 mm Finished Thickness

No.	Nature of Construction and Materials	Minimum Thickness (mm) of Protection for fire Resistance of		
		30 min	60 min	120 min
(1)	(2)	(3)	(4)	(5)
i)	37 mm (minimum) timber joists with a ceiling of:			
a)	Timber lathing and plaster, plaster of thickness	15	—	—
b)	Metal lathing and plaster, thickness of plaster:			
1)	Sanded gypsum plaster (metal lathing grade)	15	—	—
2)	Lightweight aggregate gypsum plaster	13	13	25
c)	One layer of plasterboard with taped and filled joints	12.7	—	—
d)	Two layers of plasterboard with joints staggered, joints in outer layer taped and filled total thickness	19	31	—
e)	One layer of plasterboard not less than 9.5 mm thick, finished with:			
1)	Gypsum plaster	5	—	—
2)	Sanded gypsum plaster	13	—	—
3)	Lightweight aggregate gypsum plaster	13	—	—
f)	One layer of plasterboard not less than 12.7 mm thick, finished with:			
1)	Gypsum plaster	5	—	—
2)	Lightweight aggregate gypsum plaster	10	—	—
g)	One layer of asbestos insulating board with any transverse joints backed by fillets of asbestos insulating board not less than 9 mm thick, or by timber	9	12	—

Table No. AC-16: Timber Floors – Tongued and Grooved Boarding, or Sheets of Tongued and Grooved Plywood or Wood Chipboard, of not Less than 15 mm Finished Thickness

No.	Nature of Construction and Materials	Minimum Thickness (mm) of Protection for fire Resistance of		
		30 min	60 min	120 min
(1)	(2)	(3)	(4)	(5)
i)	37 mm (minimum) timber joists with a ceiling of:			
a)	Timber lathing and plaster, plaster of thickness	15	—	—
b)	Metal lathing and plaster, thickness of plaster:			
1)	Sanded gypsum plaster (metal lathing grade)	15	—	—
2)	Lightweight aggregate gypsum plaster	13	13	25
c)	One layer of plasterboard with taped and filled joints	12.7	—	—
d)	Two layers of plasterboard with joints staggered, joints in outer layer taped and filled total thickness	22	31	—
e)	One layer of plasterboard not less than 9.5 mm thick, finished with:			
1)	Gypsum plaster	5	—	—
2)	Sanded gypsum plaster	15	—	—
3)	Lightweight aggregate gypsum plaster	13	—	—
f)	One layer of plasterboard not less than 12.7 mm thick, finished with:			
1)	Gypsum plaster	5	—	—
2)	Lightweight aggregate gypsum plaster	10	—	—
g)	One layer of asbestos insulating board with any transverse joints backed by fillets of asbestos insulating board not less than 9 mm thick, or by timber	9	12 <sup>1)</sup>	—
<sup>1)</sup> Finished on top with 25 mm minimum thick glass fibre or mineral wool laid between joints.				

Table No. AC-17: Timber Floors – Any Structurally suitable flooring of Timber or Lignocellulose Boards

No.	Nature of Construction and Materials	Minimum Thickness (mm) of Protection for fire Resistance of	
		30 min	60 min
(1)	(2)	(3)	(4)
i)	37 mm (minimum) timber joists with a ceiling of:		
a)	Timber lathing and plaster, plaster of thickness	15	—
b)	Metal lathing and plaster, thickness of plaster for:		
1)	Sanded gypsum plaster (metal lathing grade)	15	—
2)	Lightweight aggregate gypsum plaster	13	19
c)	One layer of plasterboard with joints taped and filled and backed by timber	12.7	—
d)	Two layers of plasterboard with joints staggered, joints in outer layer taped and filled total thickness	25	—
e)	Two layers of plasterboard, each not less than 9.5 mm thick, joints between boards staggered, and outer layer finished with gypsum plaster	5	
f)	One layer of plasterboard not less than 9.5 mm thick, finish with:		
1)	Sanded gypsum plaster	13	—
2)	Lightweight aggregate gypsum plaster	15	—
g)	One layer of plasterboard not less than 12.7 mm thick, finished with:		
1)	Sanded gypsum plaster	15	—
2)	Lightweight aggregate gypsum plaster	13	—
h)	One layer of asbestos insulating board with any transverse joints backed by fillets of asbestos insulating board not less than 9 mm thick, or by timber	12	—

## ANNEXURE D

### GUIDELINES FOR FIRE DRILL AND EVACUATION PROCEDURES FOR HIGH RISE BUILDINGS

#### D-1 Introduction

In case of fire in a high-rise building, safe evacuation of its occupants may present serious problems unless a plan for orderly and systematic evacuation is prepared in advance and all occupants are well drilled in the operation of such plan. These guidelines are intended to assist them in this task.

#### D-2 Alarms

Any person discovering fire, heat or smoke shall immediately report such condition to the fire brigade, unless he has personal knowledge that such a report has been made. No person shall make, issue, post or maintain any regulation or order, written or verbal, that would require any person to take any unnecessary delaying action prior to reporting such condition to the fire brigade.

#### D-3 Drills

- D-3.1 Fire drills shall be conducted, in accordance with the Fire Safety Plan, at least once every three months for buildings during the first two years. Thereafter, fire drills shall be conducted at least once every six months.
- D-3.2 All occupants of the building shall participate in the fire drill. However, occupants of the building, other than building service employees, are not required to leave the floor or use the exits during the drill.
- D-3.3 A written record of such drills shall be kept on the premises for a three years period and shall be readily available for fire brigade inspection.

#### D-4 Signs and Plan

##### D-4.1 Signs at Lift Landings

A sign shall be posted and maintained in a conspicuous place on every floor at or near the lift landing in accordance with the requirements, indicating that in case of fire, occupants shall use the stairs unless instructed otherwise. The sign shall contain a diagram showing the location of the stairways except that such diagram may be omitted, provided signs containing such diagram are posted in conspicuous places on the respective floor.

A sign shall read 'IN CASE OF FIRE, USE STAIRS UNLESS INSTRUCTED OTHERWISE'. The lettering shall be at least 12.5 mm block letters in red and white background. Such lettering shall be properly spaced to provide good legibility. The sign shall be at least 250 mm × 300 mm, where the diagram is also incorporated in it and 62.5 mm × 250 mm where the diagram is omitted. In the latter case, the diagram sign shall be at least 200 mm × 300 mm. The sign shall be located directly above the call-button and squarely attached to the wall or partition. The top of the sign shall not be above 2 m from the floor level.

##### D-4.2 Floor Numbering Signs

A sign shall be posted and maintained within each stair enclosure on every floor, indicating the number of the floor, in accordance with the requirements given below. The numerals shall be of bold type and at least 75 mm high. The numerals and background shall be in contrasting colours. The sign shall be securely attached to the stair side of the door.

##### D-4.3 Stair and Lifts Identification Signs

Each stairway and each lift bank shall be identified by an alphabetical letter. A sign indicating the letter of identification shall be posted and maintained at each lift landing and on the side of the stairway door from which egress is to be made, in accordance with the requirements given in (*Refer 14.3.4.(2)*)

#### **D-4.4 Stair Re-entry Signs**

A sign shall be posted and maintained on each floor within each stairway and on the occupancy side of the stairway where required, indicating whether re-entry is provided into the building and the floor where such re-entry is provided, in accordance with the requirements given below.

The lettering and numerals of the signs shall be at least 12.5 mm high of bold type. The lettering and background shall be of contrasting colours and the signs shall be securely attached approximately 1.5 m above the floor level.

#### **D-5 Fire Safety Plan**

D-5.1 A format for the Fire Safety Plan shall be as given in D-9.10.

D-5.2 The applicable parts of the approved Fire Safety Plan shall be distributed to all tenants of the building by the building management when the Fire Safety Plan has been approved by the Fire Authority.

D-5.3 The applicable parts of the approved Fire Safety Plan shall then be distributed by the tenants to all their employees and by the building management to all their building employees.

D-5.4 In the event there are changes from conditions existing at the time the Fire Safety Plan for the building was approved, and the changes are such so as to require amending the Fire Safety Plan, within 30 days after such changes, an amended Fire Safety Plan shall be submitted to the fire brigade for approval.

#### **D-6 Fire Command Centre**

A Fire Command Centre shall be established in the building (*Refer 14.2.4(11)*)

#### **D-7 Communications and Fire Alarm**

A means of communication and fire alarm for use during fire emergencies shall be provided and maintained by the owner or person in charge of the building.

#### **D-8 Fire Safety Plan Format**

##### **D-8.1 Building Address**

Street and Pin Code Number \_\_\_\_\_

Telephone Number \_\_\_\_\_

##### **D-8.2 Purpose and Objective**

###### **D-8.2.1 Purpose**

To establish method of systematic, safe and orderly evacuation of an area or building by and of its occupants in case of fire or other emergency, in the least possible time, to a safe area by the nearest safe means of egress; also the use of such available fire appliances (including sounding of alarms) as may have been provided for controlling or extinguishing fire and safeguarding of human life.

###### **D-8.2.2 Objective**

To provide proper education as a part of continuing employee indoctrination and through a continuing written programme for all occupants, to ensure prompt reporting of fire, the response of fire alarms as designated, and the immediate initiation of fire safety procedures to safeguard life and contain fire until the arrival of the fire brigade.

##### **D-8.3 Fire Safety Director**

- a) Name
- b) Regularly assigned employment — Title
- c) Regularly assigned location.
- d) How is he notified when at regular location?
- e) How is he notified when not at regular location?
- f) Normal working hours
- g) Duties of Fire Safety Director (see D-9.1)

**D-8.4 Deputy Fire Safety Director**

- a) Name
- b) Regularly assigned employment — Title
- c) Regularly assigned location
- d) How is he notified when at regular location?
- e) How is he notified when not at regular location?
- f) Normal working hours
- g) Duties of Deputy Fire Safety Director (see D-9.2)

**D-8.5 Fire Wardens and Deputy Fire Wardens**

- a) Are their names on organization charts for each floor and/or tenancy?
- b) Submit typical completed organization chart for Fire Drill and Evacuation Assignment.
- c) Duties of Fire Wardens and Deputy Fire Wardens (see D-9.3).

**D-8.6 Building Evacuation Supervisor**

- a) Name
- b) Regularly assigned employment — Title
- c) Regularly assigned location
- d) How is he notified when at regular location?
- e) How is he notified when not at regular location?
- f) Normal working hours
- g) Duties of Building Evacuation Supervisor (see D-9.4).

**D-8.7 Fire Party**

- a) Submit a completed organization chart for Fire Parties naming person in charge, and his title in the building.
- b) Indicate standards of selection from building employees based on background and availability.
- c) How are they notified?
- d) How are they notified when they are not at their regular locations?
- e) Means of responding
- f) Duties of each member of Fire Party (see D-9.5).

**D-8.8 Occupants Instructions**

Distribution of instructions of all tenants, tenants' employees and building employees (see D-9.6).

**D-8.9 Evacuation Drills**

- a) Frequency of drills
- b) How conducted?
- c) Participation? Who participated? How?
- d) Controls and supervision
- e) Recording of details of drills

**D-8.10 Fire Command Station**

- a) Location
- b) Requirements:
  - i Adequate illumination
  - ii Adequate communication to mechanical equipment room and lifts control room on each floor
  - iii Copy of Fire Safety Plan
  - iv Copy of Building Information Form

- v Representative floor plans showing location of signs, floor remote station, communications, etc

**D-8.11 Signs**

- a) Signs at lifts landings, Floor diagrams
- b) Floor numbering
- c) Stairway identification
- d) Lifts identification
- e) Stair re-entry

**D-8.12 Fire Prevention and Fire Protection Programme**

See D-9.7.

**D-8.13 Building Information Form**

See D-9.8

**D-8.14 Representative Floor Plan**

See D-9.9

**D-8.15 Fire Safety Plan Prepared by**

See D-9.10

- a) Date when prepared, and
- b) Date when revised

**D-9 Duties**

**D-9.1 Fire Safety Director's Duties**

- D-9.1.1 Be familiar with the written Fire Safety Plan providing for fire drill and evacuation procedure in accordance with orders on the subject.
- D-9.1.2 Select qualified building service employees for a Fire Party and organize, train and supervise such fire brigade.
- D-9.1.3 Be responsible for the availability and state of readiness of the Fire Party.
- D-9.1.4 Conduct fire and evacuation drills.
- D-9.1.5 Be responsible for the designation and training of a Fire Warden for each floor, and sufficient Deputy Fire Wardens for each tenancy in accordance with orders on the subject.
- D-9.1.6 Be responsible for a daily check for the availability of the Fire Wardens, and see that up-to date organization charts are posted<sup>12</sup>.
- D-9.1.7 Notify the owner or some other person having charge of the building when any designated individual is neglecting his responsibilities contained in Fire Safety Plan. The owner or the other person in-charge of the building shall bring the matter to the attention of the firm employing the individual. If the firm fails to correct the condition, the fire department shall be notified by the owner/person in charge of the building.
- D-9.1.8 In the event of fire, shall report to the fire command centre to supervise, provide for and coordinate with respect to the following:
  - a Ensuring that the fire department has been notified of any fire or fire alarm.
  - b Manning of the fire command station.
  - c Direction of evacuating procedures as provided in the Fire Safety Plan.
  - d Report on conditions on fire floor for information of fire department on their arrival.
  - e Advising the fire department officer in-charge in the operation of the Fire Command Centre.

---

<sup>12</sup> Note — If the number of Fire Wardens and Deputy Fire Wardens in the building is such that it is impractical to individually contact each one daily, a suggested method to satisfy the requirements is to make provisions for the Fire Warden, or a Deputy Fire Warden in the absence of the Fire Warden, to notify the Fire Safety Director when the Fire Warden or required number of Deputy Fire Wardens are not available. In order to determine the compliance by the Fire Warden and Deputy Fire Wardens, when this method is used, the Fire Safety Director shall make a spot check of several different floors each day.



D-9.1.9 Be responsible for the training and activities of the Building Evacuation Supervisor.

**D-9.2 Deputy Fire Safety Director's Duties**

- 1 He is the subordinate to the Fire Safety Director.
- 2 He shall perform duties of Fire Safety Director in his absence.

**D-9.3 Fire Warden's and Deputy Fire Warden's Duties**

The tenant or tenants of each floor shall, upon request of the owner or person in charge of buildings, make responsible and dependable employees available for designation by the Fire Safety Director as Fire Warden and Deputy Fire Wardens.

D-9.3.1 Each floor of a building shall be under the direction of a designated Fire Warden for the evacuation of occupants in the event of fire. He shall be assisted in his duties by the Deputy Fire Wardens. A Deputy Fire Warden shall be provided for each tenancy. When the floor area of a tenancy exceeds 700 m<sup>2</sup> of occupiable space, a Deputy Fire Warden shall be assigned for each 700 m<sup>2</sup> or part thereof.

D-9.3.2 Each Fire Warden and Deputy Fire Warden shall be familiar with the fire safety plan, the location of exits and the location and operation of any available fire alarm system.

D-9.3.3 In the event of fire, or fire alarm the Fire Warden shall ascertain the location of the fire, and direct evacuation of the floor in accordance with directions received and the following guidelines:

- a The most critical areas for immediate evacuation are the fire floor and floors immediately above. Evacuation from the other floors shall be instituted when instructions from the fire Command Centre or conditions indicate such action. Evacuation shall be via uncontaminated stairs. The Fire Warden shall try to avoid stairs being used by the Fire department. If this is not possible, he shall try to attract the attention of the Fire department personnel before such personnel open the door to the fire floor.
- b Evacuation to two or more levels below the fire floor is generally adequate. He shall keep the fire command station informed regarding his location.
- c Fire Wardens and their deputies shall see that all occupants are notified of the fire, and that they proceed immediately to execute the Fire Safety Plan.
- d The Fire Warden on the fire floor shall, as soon as practicable, notify the Fire Command Centre of the particulars.
- e Fire Wardens on floors above the fire shall, after executing the Fire Safety Plan, notify the Fire command station of the means being used for evacuation and any other particulars.
- f In the event that stairways serving fire floor and/or floors above are unusable due to contamination or cut-off by fire and/or smoke or that several floors above fire involve large numbers of occupants who must be evacuated, consideration may be given to using lifts in accordance with the following:
  - i) If the lifts servicing his floor also service the fire floor, they shall not be used. However, lifts may be used if there is more than one bank of lifts, and he is informed from the Fire Command Centre that one bank is unaffected by the fire.
  - ii) If lifts do not service the fire floor and their shafts have no openings on the fire floor, they may be used, unless directed otherwise.
  - iii) Lifts manned by trained building personnel or firemen may also be used.
  - iv) In the absence of a serviceable lift, the Fire Warden shall select the safest stairway to use for evacuation on the basis of the location of the fire and any information received from the Fire Command Centre. The Fire Warden shall check the environment in the stairs prior to entry for evacuation. If it is affected by smoke, alternative stair shall be selected, and the Fire Command Centre notified.
  - v) The Fire Warden shall keep the Fire Command Centre informed of the means being employed for evacuation by the occupants of his floor.
- g Ensure that an alarm has been transmitted.

D-9.3.4 Organization Chart for Fire Drill and Evacuation Assignment

A chart designating employees and their assignments shall be prepared and posted in a conspicuous place in each tenancy and on each floor of a tenancy that occupies more than one floor and a copy shall be in the possession of the Fire Safety Director.

- D-9.3.5 Keep available an updated listing of all personnel with physical disabilities who cannot use stairs unaided. Make arrangements to have these occupants assisted in moving down the stairs to two or more levels below fire floor. If it is necessary to move such occupants to a still lower level during the fire, move them down the stairs to the uppermost floor served by an uninvolved lifts bank and then evacuate them to the street floor by lifts. Where assistance is required for such evacuation, notify Fire Safety Director.
- D-9.3.6 Provide for Fire Warden identification during fire drills and fires, such as using armband, etc.
- D-9.3.7 Ensure that all persons on the floor are notified of fire and all are evacuated to safe areas. A search must be conducted in the lavatories to ensure all are out. Personnel assigned as searchers can promptly and efficiently perform this duty.
- D-9.3.8 Check availability of applicable personnel on organization chart and provide for a substitute when the position on a chart is not covered.
- D-9.3.9 After evacuation, perform a head count to ensure that all regular occupants known to have occupied the floor have been evacuated.
- D-9.3.10 When alarm is received, the Fire Warden shall remain at a selected position in the vicinity of the communication station on the floor, in order to maintain communication with the Fire Command Centre and to receive and give instructions.

#### **D-9.4 Building Evacuation Supervisor's Duties**

A Building Evacuation Supervisor is required at all times other than normal working or business hours when there are occupants in the building and there is no Fire Safety Director on duty in the building.

- D-9.4.1 He should be capable of directing the evacuation of the occupants as provided by the Fire Safety Plan.
- D-9.4.2 During fire emergencies, the primary responsibility of the Building Evacuation Supervisor shall be to man the Fire Command Centre, and the direction and execution of the evacuation as provided in the Fire Safety Plan. The Building Evacuation Supervisor's training and related activities shall be under the direction of the Fire Safety Director in accordance with these rules, and the Fire Safety Plan. Such activities shall be subject to fire department control.

#### **D-9.5 Fire Party Duties**

On receipt of an alarm for fire, the Fire Party shall,

- 1 report to the floor below the fire to assist in evacuation and provide information to the Fire Command Centre.
- 2 after evacuations of fire floor, endeavour to control spread of fire by closing doors, etc. attempt to control the fire until arrival of the fire department, if the fire is small and conditions do not pose a personal threat.
- 3 leave one member on the floor below the fire to direct the fire department to the fire location and to inform them of conditions.
- 4 on arrival of the fire department, the Fire Party shall report to the Fire Command Centre for additional instructions.
- 5 have a member designated as runner, who shall know the location of the nearest telephone, and be instructed in its use. Such member shall immediately upon receipt of information that there is a fire or evidence of fire, go to the telephone, transmit an alarm and await the arrival of the fire department and direct them to the location of the fire.<sup>13</sup>

---

<sup>13</sup> Note — A chart designating employees and their assignments shall be prepared.

#### **D-9.6 Occupant's Instructions**

- 1 The applicable parts of the approved Fire Safety Plan shall be distributed to all tenants of the building by the building management when the Fire Safety Plan has been approved by the Fire Commissioner.
- 2 The applicable parts of the approved Fire Safety Plan shall then be distributed by the tenants to all their employees and by the building management to all their building employees.
- 3 All occupants of the building shall participate and cooperate in carrying out the provisions of the Fire Safety Plan.

#### **D-9.7 Fire Prevention and Fire Protection Programme**

- 1 A plan for periodic formal inspections of each floor area, including exit facilities, fire extinguishers and housekeeping shall be developed. A copy of such plan be submitted.
- 2 Provision shall be made for the monthly testing of communication and alarm systems.

#### **D-9.8 Building Information Form**

It shall include the following information:

- 1 Building address \_\_\_\_\_ Pin Code \_\_\_\_\_
- 2 Owner or person in-charge of building — Name, Address and Telephone Number.
- 3 Fire Safety Director and Deputy Fire Safety Director's Name and Telephone Number.
- 4 Certificate of occupancy. Location where posted, or duplicate attached.
- 5 Height, area, class of construction.
- 6 Number type and location of fire stairs and/ or firefighting shaft.
- 7 Number, type and location of horizontal exits or other areas of refuge.
- 8 Number, type, location and operation of lifts and escalators.
- 9 Interior fire alarms, or alarms to central stations.
- 10 Communications systems and/or walkie-talkie, telephones, etc.
- 11 Standpipe system; size and location of risers, gravity or pressure tank, fire pump, location of siamese connections, name of employee with certificate of qualification and number of certificate.
- 12 Sprinkler system; name of employee with Certificate of Fitness and certificate number.  
m Primary and secondary water supply, fire pump and areas protected.
- 13 Special extinguishing system, if any, components and operation.
- 14 Average number of persons normally employed in building (Daytime and night time).
- 15 Average number of persons with disabilities in building and their location (Daytime and night time).
- 16 Number of persons normally visiting the building (Daytime and night time).
- 17 Service equipment such as:
  - a) Electric power, primary, auxiliary;
  - b) Lighting, normal, emergency, type and location;
  - c) Heating, type, fuel, location of heating unit;
  - d) Ventilation — with fixed windows, emergency means of exhausting heat and smoke;
  - e) Air conditioning systems — Brief description of the system, including ducts and floors serviced;
  - f) Refuse storage and disposal;
  - g) Firefighting equipment and appliances, other than standpipe and sprinkler system;
  - h) and other pertinent building equipment.
- 18 Alternations and repair operations, if any, and the protective and preventive measures
- 19 Necessary to safeguard such operations with attention to torch operations.
- 20 Storage and use of flammable solids, liquids and/or gases.
- 21 Special occupancies in the building and the proper protection and maintenance thereof.
- 22 Places of public assembly, studios, and theatrical occupancies.

**D-9.9 Representative Floor Plan**

A floor plan, representative of the majority or the floor designs of the entire building, shall be at the Command Post, in the main lobby, under the authority of the Fire Safety Director. One copy of a representative floor plan shall be submitted to the Fire department with the Fire Safety Plan.

**D-9.10 Fire Safety Plan**

In planning, evaluate the individual floor layouts, the population of floors, the number and kinds of exits, the zoning of the floor by area and occupants. Determine the movement of traffic by the most expeditious route to an appropriate exit and alternative route for each zone, since under fire conditions one or more exits may not be usable. This format should be used in the preparation of the Fire Safety Plan. Nothing contained in this Fire Safety Plan format shall be construed as all inclusive. All rules and other requirements shall be fully complied with.

**D-9.11 Personal Fire Instruction Card**

All the occupants of the building shall be given a Personal Fire Instruction Card giving the details of the floor plan and exit routes along with the instruction to be followed in the event of fire. A typical Personal Fire Instruction Card shall be as follows:

PERSONAL FIRE INSTRUCTION CARD

SEAL

NAME OF THE ORGANIZATION

ADDRESS OF THE ORGANIZATION

NAME: \_\_\_\_\_

DESIGNATION: \_\_\_\_\_

FLOOR NO. : \_\_\_\_\_

DATE : \_\_\_\_\_

FIRE WARDEN

**INSTRUCTIONS**

**FOR YOUR OWN SAFETY YOU SHOULD KNOW**

- 1 Two push button fire alarm boxes are provided per floor. You should read the operating instructions.
- 2 You should read the operating instructions on the body of the fire extinguishers provided on your floor.
- 3 The nearest exit from your table.
- 4 Your assembly point on ground floor (check with your Fire/Deputy Fire Warden).
- 5 **FOR YOUR OWN PROTECTION YOU SHOULD REPORT TO YOUR FIRE/**
- 6 **DEPUTY FIRE WARDEN**
  - a) If any exit door/route is obstructed by loose materials, goods, boxes, etc.
  - b) If any staircase door, lift lobby door does not close automatically, or does not close completely.
  - c) If any push button fire alarm point, or fire extinguisher is obstructed, damaged or apparently out of order.

**IF YOU DISCOVER A FIRE**

- 1 Break the glass of the nearest push button fire alarm and push the button.
- 2 Attack the fire with extinguishers provided on your floor. Take guidance from your Wardens.
- 3 Evacuate, if your Warden asks you to do so.

**IF YOU HEAR EVACUATION INSTRUCTIONS**

- 1 Leave the floor immediately by the nearest staircase as directed.
- 2 Report to your Warden, at your predetermined assembly point outside the building.
- 3 Do not try to use lifts.
- 4 Do not go to cloakroom.
- 5 Do not run or shout.
- 6 Do not stop to collect personal belongings.
- 7 Keep the lift lobby and staircase doors shut.

# ANNEXURE E

## ADDITIONAL REQUIREMENTS FOR HIGH RISE BUILDINGS

### E-1 General

High rise buildings (15 m and above in height) shall receive special attention with respect to fire and life safety particularly with regard to planning, design, execution, maintenance and training so that the intended provisions of this Code are well implemented. These get further accentuated as the buildings go taller; some of the key aspects are as follows:

- 1 Staging and evacuation requirements of occupants.
- 2 Stack effect posing challenges towards pressurization and smoke exhaust.
- 3 Zoning of firefighting system to meet functional requirements of hydraulic pressure and flow.
- 4 Challenges experienced by fire personnel in reaching the place of fire and towards evacuation.

Aspects to mitigate these challenges require innovative approach, interaction with local fire authorities and meaningful strategic planning towards maintenance and fire drills.

### E-2 Egress and Evacuation Strategy

One firefighting shaft shall be planned for each residential building/tower, in an educational building/ block, and for each compartment of institutional, assembly, business and mercantile occupancy types. For other occupancy types, requirement of firefighting shaft shall be ascertained in consultation with the local fire authority. The firefighting shaft shall necessarily have connectivity directly to exit discharge or through exit passageway (having 120 min fire resistance walls) to exit discharge.

Staircase and fire lift lobby of a firefighting shaft shall be smoke controlled as per Rule 14.3.4 and Table No 14.6.

It is recommended that the pressurization requirement for staircase in firefighting shaft and for other fire exit staircases in buildings greater than 60 m in height be evaluated to limit the force required to operate the door assembly (in the direction of door opening) to not more than 133 N to set the door leaf in motion. The aspect of pressurization, door area/width and door closure shall be planned in consideration to the above.

### E-3 Fire Safety Requirements for Lifts

The provisions as given in 7.1 to 7.2.4 under fire safety requirements of lifts in high rise buildings in Part VIII 'Building Services, Section 5 Installation of Lifts, Escalators and Moving Walks, Subsection 5A Lifts', National Building Code shall be applicable.

### E-4 Horizontal Exit/Refuge Area

A horizontal exit shall be through a fire door of 120 min rating in a fire-resistant wall. Horizontal exit require separation with the refuge area or adjoining compartment through 120 min fire barrier. The adjoining compartment of the horizontal exit should allow unlocked and ease of egress and exits for the occupants using defend in place strategy.

Requirements of horizontal exits are as under:

- 1 Width of horizontal exit doorway shall be suitable to meet the occupant load factor for egress.
- 2 Doors in horizontal exits shall be openable at all times from both sides.
- 3 All doors shall swing in the direction of exit travel. For horizontal exits, if a double leaf door is used, the right hand door leaf shall swing in the direction of exit travel.
- 4 Refuge area shall be provided in buildings of height more than 24 m. Refuge area provided shall be planned to accommodate the occupants of two consecutive floors (this shall consider occupants of the floor where refuge is provided and occupants of floor above) by considering area of 0.3 m<sup>2</sup> per person for the calculated number of occupants and shall include additionally to accommodate one wheelchair space of an area of 0.9 m<sup>2</sup> for every 200 occupants, portion thereof, based on the occupant load served by the area of refuge or a minimum of 15 m<sup>2</sup>, whichever is higher, shall be provided as under:

- a) The refuge area shall be provided on the periphery of the floor and open to air at least on one side protected with suitable railings.
  - b) Refuge area(s) shall be provided at/or immediately above 24 m and thereafter at every 15 m or so.
- 5 The above refuge area requirement for H-2 occupancy requirement shall however be in accordance with life safety provisions for H-2 occupancy.
  - 6 A prominent sign bearing the words 'REFUGE AREA' shall be installed at the entry of the refuge area, having height of letters of minimum 75 mm and also containing information about the location of refuge areas on the floors above and below this floor. The same signage shall also be conspicuously located within the refuge area.
  - 7 Each refuge area shall be ventilated and provided with first aid box, fire extinguishers, public address speaker, fire man talk back, and adequate emergency lighting as well as drinking water facility.
  - 8 Refuge areas shall be approachable from the space they serve by an accessible means of egress.
  - 9 Refuge areas shall connect to firefighting shaft (comprising fireman's lift, lobby and staircase) without having the occupants requiring to return to the building spaces through which travel to the area of refuge occurred.
  - 10 The refuge area shall always be kept clear. No storage of combustible products and materials, electrical and mechanical equipment, etc shall be allowed in such areas.
  - 11 Refuge area shall be provided with adequate drainage facility to maintain efficient storm water disposal.
  - 12 Entire refuge area shall be provided with sprinklers.
  - 13 Where there is a difference in level between connected areas for horizontal exits, ramps of slope not steeper than 1 in 12 shall be provided (and steps should be avoided).<sup>14</sup>

High rise apartment buildings with apartments having balcony, need not be provided with refuge area; however, apartment buildings without balcony shall provide refuge area as given above. Refuge areas for apartment buildings of height above 60 m while having balconies shall be provided at 60 m and thereafter at every 30 m. The refuge area shall be an area equivalent to 0.3 m<sup>2</sup> per person for accommodating occupants of two consecutive floors, where occupant load shall be derived on basis of 12.5 m<sup>2</sup> of gross floor area and additionally 0.9 m<sup>2</sup> for accommodating wheel chair requirement or shall be 15 m<sup>2</sup>, whichever is higher.

### **E-5 Electrical Services**

The specific requirements for electrical installations in multi-storeyed buildings given in Part VIII 'Building Services, Section 2 Electrical and Allied Installations' of the Code and Section VII of National Electrical Code 2011 shall be followed.

Wherever transformers are planned at higher floors, the HT cables shall be routed through a separate shaft having its own fire resistance rating of 120 min. Wherever HT generators are planned centrally at ground or first basement level, redundant transformers and HT cables shall be planned for buildings above 60 m in height.

### **E-6 Fire Protection**

For residential occupancies above 120 m in height and other occupancies above 60 m in height, the sprinklers shall be fed from the main and an alternate/standby riser with suitable isolation valves. The entire sprinkler system shall be designed in accordance with good practice (*Refer Annexure K (20)*).

Where the height of the building exceeds 150 m to 175 m, fire water static storage and pumps shall be required to be provided at 160 m to 180 m and thereafter at intermediate floors at higher levels enabling efficient and functional firefighting installations. The static fire water storage tanks located at such levels shall have capacity at minimum half of the storage of underground static water storage

<sup>14</sup> Note — Refuge area provided in excess of the requirements shall be counted towards FAR.

tank prescribed in Table No. 14.7. Such tanks shall be supplemented with water supplies through one working and one standby pump of capacity 2850 litre/min with two risers at alternate locations feeding to such fire water static storage tanks. The fire pump's requirement and capacity shall also be derived for occupancy type as per Table No. 14.7 substituting the diesel pump with electrical pump. The fire pump room at such level shall have dedicated connectivity through passageway (with 120 min integrity) from the firefighting shaft. Such fire pump room shall have 120 min fire resisting wall and provided with adequate ventilation with talk-back connectivity to the main fire pump room and Fire Command Centre.

For high rise buildings, seismic bracings shall be considered for firefighting installations depending on seismic vulnerability of the region and the type of occupancy.

#### **E-7 Fire and Life Safety Audit**

- 1 Fire and life safety audit shall be carried out for all buildings having a height of more than 15 m.
- 2 Such audits shall preferably be conducted by a third party auditor having requisite experience in fire and life safety inspections.
- 3 Frequency of such audits shall be once in two years.

#### **E-8 Helipad**

For high rise buildings above 200 m in height, provision for helipad is recommended for specific requirements like landing of fire equipment, and support facilities or other emergencies.



# ANNEXURE F

## ATRIUM

### F-1 Atrium Requirements

- 1 In order for an atrium to be permitted in buildings, the following shall be complied:
  - a) Atrium shall be permitted in buildings of Type 1 and Type 2 construction only.
  - b) The use of combustible furnishings and decorations on the floor of the atrium shall be limited and sparsely distributed.
- 2 Smoke detectors shall be provided on the underside of each floor protruding into the atrium, at the atrium roof and adjacent to each return air intake from the atrium. Within atrium space, beam type or aspirating type smoke detectors shall be used to ensure detection of smoke, considering factors such as stratification of smoke.
- 3 Where the ceiling of the atrium is more than 17 m above the floor, water based protection (automatic sprinklers) at the ceiling of atrium is not required.
- 4 Hydrants shall be available at the floor of the atrium and also at the adjoining upper spaces/floors of the atrium. Sprinklers are required to be installed for coverage of glass areas of retail, tenant and other areas adjoining the exit access corridor and atrium. Sprinklers shall be at a distance of 450 mm to 600 mm enabling cooling of such glass and limiting the extent of fire and smoke to the atrium (*see Figure No. AF-1*). This provision does not allow similar sprinkler installation arrangement to offset fire compartmentation requirements, in which case fire barrier is required as per relevant provisions of this Part.
- 5 Atrium in business occupancy shall be planned with 6 air changes per hour (ACPH) while atrium in hotels and assembly occupancy shall be planned with 8 ACPH smoke extraction system. Such air changes shall be planned in atrium for a height of 15 m from the top.
- 6 Smoke exhaust fans shall be capable of operating effectively at 250°C for 120 min.
- 7 Makeup air supply points shall be located beneath the smoke layer and on the lower levels connected by the atrium.
- 8 Makeup air shall be provided by fans, openings to outside to allow infiltration, or the combination thereof.
- 9 It is recommended that makeup air be designed at 85 percent to 95 percent of the exhaust flow rate, not including the leakage through these small paths.
- 10 The makeup air shall not cause door-opening force to exceed allowable limits.
- 11 The makeup air velocity shall not exceed 1.02 m/s where the makeup air could come into contact with the plume unless a higher makeup air velocity is supported by engineering analysis.
- 12 Atrium smoke management system fans shall be provided with emergency power.
- 13 If so required by the Authority, an engineering analysis should be performed which demonstrates that the smoke system for the atrium is designed to keep the smoke layer interface 1800 mm above the highest occupied floor level of exit access, open to the atrium, for a period equal to 1.5 times the calculated egress time or 20 min, whichever is greater.

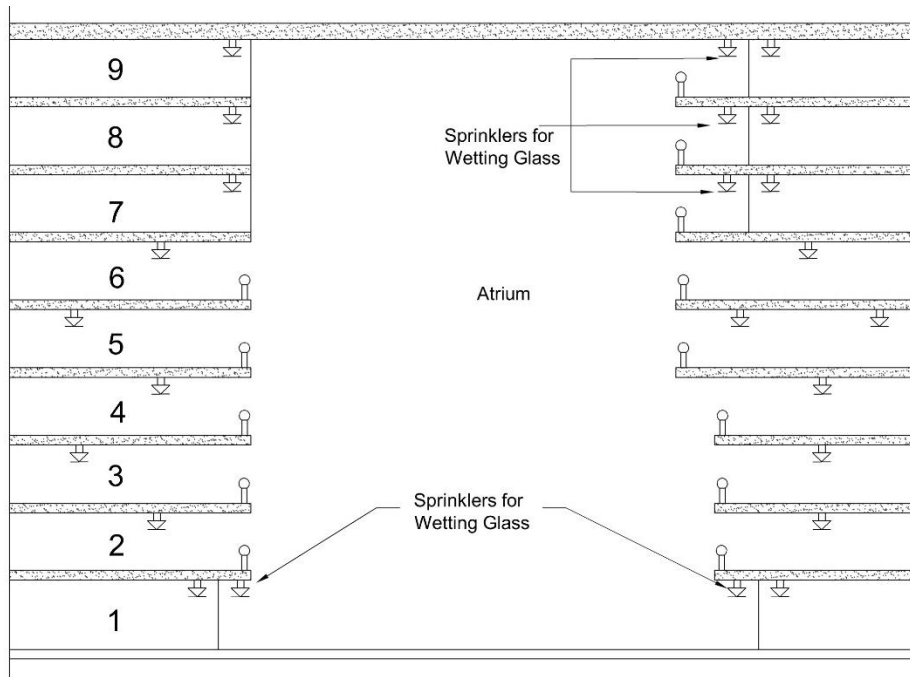

Figure No. AF-1: Sprinkler protection of glass for floor open to Atrium

# ANNEXURE G

## COMMERCIAL KITCHENS

### **G-0 General**

The provisions given herein are applicable to those commercial kitchens serving in centrally air-conditioned buildings such as kitchens of starred hotels, food courts, malls, banquet halls and restaurants.

Electricity, gas and in some cases solid fuels such as wood or charcoal are the energy sources used to power a commercial kitchen.

The potential hazards posed by the commercial cooking facilities are as follows:

- 1 On cooking appliances using oil as fuel — The oil can self-ignite due to overheating of the cooking appliances or through open flames.
- 2 Full grease residues trapped in the hoods due to non-cleaning of filters and dusts periodically and exhaust ventilation system can ignite through overheated air flues or open flames.
- 3 Faulty electrical equipment and electrical installation are more likely to spark, and failure of thermostat and safety switches that may lead to overheat and consequent fire.
- 4 Flammable materials in the vicinity of open flames or heat sources

### **G-1 Terms Associated with Cooking Operations**

- 1 *Types of restaurants/food preparation facilities* — Buffet restaurants, cafeterias, coffee shops, entertainment facilities (nightclubs, dinner theatres), and ethnic, fast food, speciality and traditional restaurants, corporate canteens, casinos, educational facilities, schools and universities, hospitals, care homes, mental homes and prisons.
- 2 *Ventilation/grease extraction equipment* — Exhaust hoods, grease removal devices, exhaust ductwork, exhaust fans, dampers and other ancillary components or systems that are involved in the capture, Containment, and control of grease-laden cooking effluent.
- 3 *Cooking appliances* — Ranges, deep fat fryers, microwave ovens, griddles, grills, pressurized fryers, potato chip fryers, woks, broilers, doughnut fryers, barbecue/smokers, ovens, Tandoors, steam kettles, appliances initializing grease and cooking oils, etc.

### **G-2 Fire Protection Systems**

- 1 A kitchen fire suppression system needs to be installed whenever cooking appliances are using LPG/PNG/oil/electricity and/or dry fuel like wood or charcoal for cooking and/or can ignite the exhaust or fat for cooking and/or can ignite the ventilation system. Cooking equipment that produces grease-laden vapours and that might be a source of ignition of grease in the hood, grease removal device, or duct shall be protected by fire-suppression equipment.
- 2 The initial fire hazard is the cooking appliance itself. However, once the exhaust ventilation system is involved in fire due to propagation from the appliances, the exhaust system becomes the more severe hazard due to the potential of fire propagation outside the cooking space.
- 3 The requirement for kitchen fire suppression systems shall be directly linked to measurements that actually represent the risk. Some other contributory factors could be but not necessarily — connected load (kW), area occupied by kitchen equipment, volume of cooking oil and other flammables, inter distances between equipment, cooking media, etc.
- 4 Grease laden hoods can be ignited by heat penetrating the outside of the kitchen hood. Any penetration to the outside of a hood, shall be either welded or fitted with an approved sealing device so as not to allow cooking grease and oil to migrate to the outer portion of the hood.
- 5 If sprinkler protection is specified for a building, it needs careful consideration of the likely consequences if certain portion of the building is omitted from the scope of protection, for example, no water should get on the cooking appliances (especially the fryer). Removing

this protection from a high hazard area logically requires this area to be protected by a more suitable solution, dedicated to this special hazard.

### **G-3 FIRE SEPARATION REQUIREMENTS**

- 1 Where a kitchen is required for the preparation of food and/or where 'open flame' cooking appliances are used and/or where fryers (with no open flames) are used, the kitchen shall be separated from other parts of the same building by compartment wall and floor having fire resistance of at least 60 min.
- 2 Food serving areas shall be fire separated from the kitchens/cooking areas by fire rated elements having a resistance of at least 60 min. Doors shall have fire resistance of 60 min rating and fitted with automatic self-closing device.
- 3 In open type kitchen cooking area, sitting area needs to be segregated by 60 min fire rated glass or drop fire curtains [*Refer G-3(4) and G-5.2(2)*].
- 4 Where the flue or exhaust duct passes through the compartment wall or floor, the flue or duct shall be encased by non-combustible construction and no damper shall be permitted to be installed in such flue or duct. Also such flue or ductwork shall be clear from combustible materials.
- 5 If the commercial kitchen/cooking is situated in a building that is not sprinkler protected, the floor area of the kitchen/cooking shall not exceed 50 m<sup>2</sup>.
- 6 Commercial kitchen/cooking using LPG as fuel for the 'open flame' cooking activities shall not be allowed to be located at the basements. As regards LPG cylinder storage, attention is drawn to good practice (Annexure K(14)) and Part VIII 'Building Services, Section II Electrical and Allied Installations' of the Code for compliance requirements
- 7 It is advisable to locate the kitchen/cooking operations on the external periphery of the building so that in the event of mechanical ventilation failure, it can be naturally ventilated.

**G-4** Life safety and egress requirements shall be governed by the requirements under life safety (*Refer Rule 14.3*). In case the requirements under this Annexure differs from those under Rule 14.3, this Annexure shall take precedence.

### **G-5 Fire Safety Requirements**

#### **G-5.1 General**

- 1 The following equipment must always be kept in working condition:
  - a) Cooking equipment,
  - b) Hoods,
  - c) Exhaust ducts (if provided),
  - d) Fans,
  - e) Fire extinguishing systems,
  - f) Fire detection and alarm system, and
  - g) Gas leakage detectors (if gas is used as fuel).
- 2 An automatic fixed suppression system shall be installed to protect all cooking equipment producing grease laden vapours and that might be a source of ignition of grease in the hood, grease removal device.
- 3 Fire-suppression equipment shall be provided for the protection of grease removal devices, hood exhaust plenums, and exhaust duct systems.
- 4 All fire suppression systems and components installed shall be in accordance with relevant Indian and/or International Standards.

#### **G-5.2 Protection of Cooking Equipment (General)**

- 1 Cooking equipment shall be protected with the following:
  - a Automatic wet chemical fire suppression system for the protection of hoods (OR) other equivalent approved systems like water mist applications for kitchen fires.
  - b Automatic sprinkler system for noncooking areas (not in the vicinity of cooking areas or inside hoods).

- c Exhaust ducts shall be protected by automatic high temperature sprinklers designed as per good practice (*Refer Annexure K(20)*)
- 2 Due diligence shall be exercised before considering protection with sprinkler/water mist installation particularly for the protection of fryers. No sprinklers shall be provided within 3 m of cooking equipment and kitchen hoods. Area sensitive to sprinklers shall be protected with wet chemical suppression systems or other approved systems for the type of protection. Water mist systems, if approved for use for the type of application (that is, commercial cooking equipment) by fire tests, may also be considered.
- 3 Kitchen hoods independent suppression systems shall discharge wet chemicals to all areas of a kitchen range extract hood that is potentially coated in grease. The system shall also discharge over deep fat cooking pans or other potential fire source. The system shall be activated by heat detectors located above the appliances/within hoods and in the entrance to exhaust duct. Additional detectors behind equipment in the duct may be necessary. These may be of fusible link type. Extinguishing systems shall also incorporate manually actuating devices which shall be located in easily accessible locations in the means of egress.
- 4 The operational sequence shall be as follows:
  - a) On detection of fire in the hood and upon actuation of fire suppression system, any power or gas supplies serving the kitchen equipment must be cut-off and isolated automatically.
  - b) Pressure regulating stations shall be designed and installed at critical locations for excess flow shut off valves.
  - c) Seismic shut off valve at the main distribution point shall also be provided.
  - d) The exhaust fan shall not stop and continue operating, even after activation of the system. The supply fan shall switch off.
  - e) Gas leakage detectors shall be provided in all kitchens that link to a gas solenoid valve for emergency shut off. Suitable gas detection system (based on type of gas used LPG or PNG) integrated with fire detection and alarm system must be provided in addition to heat/multi-criteria detectors and sprinklers.
  - f) Manually operating devices shall immediately activate fire suppression system, which in turn shall shut off other systems like fuel supply/power supply, etc. Manual system shall operate mechanically and not rely on electrical power for activation, unless this is from an emergency power source as described in this Code.
  - g) In the event of the kitchen hood system being activated, an alarm should be sounded. The system must also be interfaced with the fire detection and alarm system.
- 5 Fire extinguishers in the vicinity of cooking area and the hoods shall be suitable for the type of fire.

### **G-5.3 Cooking Equipment Exhaust Ventilation**

- 1 Hoods/ducts containing automatic fire suppression systems are protected areas; therefore, these hoods are not considered obstructions to overhead sprinkler systems and shall not require floor coverage underneath thereof.
- 2 Sprinkler installation shall comply with various provisions contained in accepted standard (*Refer Annexure K(28)*). The temperature rating of sprinklers shall be so selected that it is 30°C above the anticipated maximum temperature within cooking/kitchen areas. Sprinklers provided inside the exhaust ducts shall be of 141°C temperature.
- 3 Provision of cleaning of the kitchen exhaust every six months to ensure that the carbon soot accumulated in the exhaust duct is cleaned to avoid the chances of outbreak of fire shall be made.
- 4 Independent exhaust ducts shall be provided for equipment using dry fuel like wood/charcoal which produce spark and are likely to ignite the grease which might have accumulated in the common duct.
- 5 Alternatively, approved spark arrestors may be provided before the duct from equipment using dry fuel meets the main duct. These spark arrestors shall be so provided that these are easily accessible and removable for cleaning.

#### **G-5.4 Cooking Equipment**

- 1 Cooking equipment (such as deep fat fryers, rangers, griddles, and broilers) that may be a source of ignition shall be provided in accordance with the provision of G-5.2(1).
- 2 The operation of any sprinkler within the kitchen or cooking area shall automatically shut off all sources of fuel and heat to all equipment requiring protection. Any gas appliance not requiring protection but located under ventilating equipment shall also be shut off. All shutdown devices shall be of the type that requires manual resetting prior to fuel or power being restored.
- 3 An approved indicating valve (flow indicating switch) shall be installed in the water supply line feeding to the sprinklers protecting the cooking and extraction ventilating system.
- 4 A system test connection shall be provided to verify proper operation of equipment specified in item G-5.2(4)(d).
- 5 Sprinklers shall be inspected at least twice in a year and cleaned, if found coated with grease and other particles during their use and thus their thermal sensing elements desensitized.
- 6 Any penetrations to the outside of a hood, be either welded or fit with a sealing device (certified by national/international approval bodies) to not allow cooking grease, oil to migrate to the outer portion of the hood. The fitment arrangements shall be of approved type. Gaskets for the panels shall be certified to withstand a temperature of 815.6°C (1 500°F).
- 7 Grease strip shall be readily available for efficient and regular cleaning of concrete or paved floors of kitchen and restaurant and also the drainage areas.
- 8 The hood or that portion of a primary collection means designed for collecting cooking vapours and residues shall be constructed of and be supported by steel not less than 1.09 mm (No. 18 MSG) in thickness or stainless steel not less than 0.94 mm (No. 20 MSG) in thickness or other approved material of equivalent strength and fire and corrosion resistance.
- 9 All seams, joint, and penetrations of the hood enclosure that direct and capture grease-laden vapours and exhaust gases shall have a liquid tight continuous external weld to the hood's lower outermost perimeter.
- 10 Grease filters shall be of steel rigid construction that will not distort or crush under normal operation handling and cleaning conditions. They shall be so arranged that all exhaust air passes through the grease filters. Filters shall be easily accessible and removable for periodic cleaning.
- 11 Grease filters shall be installed at an angle not less than 45° from the horizontal.
- 12 Grease filters shall be equipped with a grease drip tray beneath their lower edges and shall have a suitable minimum depth needed to collect grease. The grease drip trays shall be pitched to drain into an enclosed metal container having a capacity not exceeding 3.8 litre.
- 13 The exhaust ducts shall be constructed of and supported by carbon steel not less than 1.37 mm (No. 16 MSG) in thickness or stainless steel not less than 1.09 mm (No. 18 MSG) in thickness.

#### **G-5.5 Rooftop Terminations — Exhaust Systems**

- 1 The exhaust system shall terminate either outside the building with a fan or duct or through the roof or to the roof from outside with minimum 3 m of horizontal clearance from the outlet to the adjacent buildings, property lines and air intakes.
- 2 There shall be a minimum of 1.5 m of horizontal clearance from the outlet (fan housing) to any combustible structure.
- 3 There shall be a vertical separation of 1.0 m below any exhaust outlets for air intakes within 3.0 m of the exhaust outlet.

# ANNEXURE H

## CAR PARKING FACILITIES

H-1 The provisions given in H-2 to H-5 shall apply to parking structures of the closed or open type, within buildings above or below grade.

### H-2 General

- 1 Where both parking and repair operations are conducted in the same building, the entire building shall comply with the requirements for Group G occupancies, unless the parking and repair sections are effectively separated by separation walls of 120 min.
- 2 Floor surfaces shall be non-combustible, sloping towards drains to remove accumulation of water.
- 3 Those parts of parking structures located within, immediately above or below, attached to, or less than 3 m away from a building used for any other purpose shall be separated by fire-resistant walls and floors having fire resistance rating of not less than 120 min. This shall exclude those incidental spaces which are occupied by cashier, attendant booth or those spaces used for toilets, with a total area not exceeding 200 m<sup>2</sup>.
- 4 Vehicle ramps shall not be considered as exits unless pedestrian facilities are provided.
- 5 Other occupancies like fuel dispensing, shall not be allowed in the building. Car repair facilities, if provided, shall be separated by 120 min fire resistant construction.
- 6 In addition to fire protection requirements as per Table No. 14.7, appropriate fire detection and suppressions systems shall be provided for the protection of hydraulic oil tank and pumps located below ground level for operation of car lifts.
- 7 Means of egress shall meet the requirements specified in Rule 14.3.

### H-3 Open Parking Structures (*Including Multi-Level Parking and Stilt Parking*)

- 1 The term open parking structure specifies the degree to which the structure's exterior walls must have openings. Parking structures that meet the definition of the term open parking structure provide sufficient area in exterior walls to vent the products of combustion to a greater degree than an enclosed parking structure.
- 2 A parking structure having each parking level wall openings open to the atmosphere, for an area of not less than 0.4 m<sup>2</sup> for each linear metre of its exterior perimeter shall be construed as open parking structure. Such openings shall be distributed over 40 percent of the building perimeter or uniformly over two opposing sides. Interior wall lines shall be at least 20 percent open, with openings distributed to provide ventilation, else, the structure shall be deemed as enclosed parking structures.<sup>15</sup>
- 3 All stilt parking are required to be provided with sprinkler system where such buildings are required to be sprinklered.
- 4 Open parking structures are not required to be provided with compartmentation.
- 5 Open car parking (open to sky) within building complex having fire hydrant system shall also need to be protected with yard hydrant installation system in accordance with good practice (*Refer Annexure K(29)*).

---

<sup>15</sup> Note — A car park located at the stilt level of a building (not open to sky) can be considered an open or an unenclosed car park if any part of the car park is within 30 m of a permanent natural ventilation opening and any one of the following is complied with towards the permanent natural ventilation requirement:

- i) 50 percent of the car park perimeter shall be open to permanent natural ventilation.
- ii) At least 75 percent of the car park perimeter is having the 50 percent natural ventilation opening.

#### **H-4 Enclosed Parking Structures**

- 1 Those car parking structures which are enclosed on all sides and on top, not falling within the definition of open car parking [see H-3(2)] and also those situated in the basements shall be known as enclosed car parking structures.
- 2 All sprinklers in car parking shall be standard response type with minimum K-Factor of 80, area coverage of 9 m<sup>2</sup> and designed as per good practice (*Refer Annexure K(20)*)
- 3 For basement car parking, compartmentation can be achieved, with fire barrier or with water curtain nozzle (K-23) or with combination thereof. Automatic deluge system comprising deluge valve, piping, nozzles, etc shall be used to zone the compartment in case of water curtain system. In case of water curtain, existing water storage shall be supplemented by water demand for water curtain nozzles for 60 min considering the largest compartment's perimeter out of all compartments of car parking in any of the basements.
- 4 The water supply for the water curtain nozzles shall be through independent electric pump of adequate capacity (flow and head) with piping/riser for the water supply to the nozzles.
- 5 The water curtain shall be operated by the actuation of flow switch actuating sprinkler system.
- 6 For smoke ventilation requirement of car parking, Refer Rule 14.3.5.
- 7 All fire exit doors from the car parking to exits shall be painted green and shall display exit signage.

#### **H-5 Automated Car Parking Utilizing Mechanical or Computerized / Robotics Means**

- 1 Automated car parking structure can be of open parking type or enclosed types.
- 2 Automated car parking facilities pose more hazard compared to manual parking due to following reasons:
  - a) High density of cars due to close stacking one over another.
  - b) Lack of provision on fire separation/ compartmentation-horizontal or vertical leading to rapid fire spread.
  - c) Non-availability of any person to notice/ control the fire in initial stages.
  - d) Limited access to firefighting personnel.
  - e) Extensive height and depth involved with highly combustible load.
- 3 Fire escape staircases, at least 1250 mm wide shall be provided at appropriate locations so that no place is more than 45 m from the nearest staircase. Horizontal walkways, at least 1000 mm wide for access to all the areas shall be provided at every parking level.
- 4 Travel distance and means of egress shall be governed by the respective sections of this Code.
- 5 The hazardous areas like DG sets, transformers, HT/LT panels for the parking lot shall be suitably segregated from other areas as per requirements given in this Code and all such areas shall be protected by suitable automatic fire suppressions systems.



## ANNEXURE J

### FIRE PROTECTION CONSIDERATIONS FOR VENTING IN INDUSTRIAL BUILDINGS

#### **J-1 Application**

- J-1.1 The provisions given below are applicable only to single storey industrial buildings (factories and storage buildings) covering large floor areas without sub-dividing/separating walls which are usually designed to meet modern production methods.
- J-1.2 The requirements of fire and explosion venting of industrial buildings, as dealt with in this section, fall under two categories:
  - a) Smoke and fire venting, and
  - b) Explosion relief vents.

#### **J-2 Smoke and Fire Venting**

- J-2.1 The basic considerations for formulating the design and other requirements for smoke and fire vents are as given in J-2.1.1 to J-2.1.20.
- J-2.1.1 The smoke and hot combustion products from a fire, being lighter than the surrounding air, tend to rise, and on reaching the roof or ceiling spread out (mushroom) on all sides and form a layer which floats on top of the cold air beneath. In the absence of vents, this layer becomes progressively deeper until the whole building is filled with hot smoky gases. The time consumed for this to happen may be only a few minutes, depending on variables like, type of materials on fire, process/storage conditions involved, etc.
- J-2.1.2 The hot gases at the roof level moved by convection currents contribute to rapid lateral spread of fire.
- J-2.1.3 The provision of properly designed and suitably located vents in adequate number helps the speedy removal of smoke and hot gases, thereby preventing spread of fire, besides reducing risks of explosion of unburnt gases and reducing damage to the contents and structure of the building by heat and smoke. In addition, they facilitate firefighting operations, and minimise personal hazards to the firemen.
- J-2.1.4 The time taken for accumulation of smoke and hot gases within a building on fire being very short, the venting devices installed shall be designed to operate in the early stage of the fire and must be automatic so as to ensure speed and efficiency in their operation.
- J-2.1.5 The smoke and fire venting system shall be designed in such a manner as to keep the temperature of the combustion products from the fire as low as possible, preferably below approximately 150°C.
- J-2.1.6 Automatic venting systems are complementary to the fire extinguishing systems, and automatic sprinklers, where provided, should operate before the operation of the vents; otherwise, venting may delay sprinkler operation.
- J-2.1.7 It is easier to vent a building of smoke than clear it of smoke once it has been filled.
- J-2.1.8 Venting is particularly desirable in large area industrial buildings or warehouses, windowless buildings, underground structures or in areas housing hazardous operations. Automatic fire vents shall be provided for all industrial occupancies (including storage buildings) classified as medium hazard or above having floor areas exceeding 750 m<sup>2</sup>, irrespective of whether they are compartmentalized or not.
- J-2.1.9 These provisions do not cover other aspects, of ventilation (or lighting) designed for regulation of temperature within a building for personal comfort or meeting process needs.
- J-2.1.10 Similarly, fire and smoke venting requirements as given here under are also not applicable to multi-storeyed buildings, as their requirements are different and more complex.
- J-2.1.11 It is difficult to determine precise venting requirements on account of the many variables involved. For instance, the rate of combustion varies appreciably according to the nature, shape, size and packaging of the combustible materials as well as the size, height and disposition of the stacks of materials.

- J-2.1.12 In industrial buildings of floor area less than 750 m<sup>2</sup> and used as low fire hazard occupancies, conventional ventilators fitted high up near the eaves of the external walls may serve as vents for smoke and hot gases, provided care is taken to ensure that they are kept open at all times or are designed to open automatically in case of fire.
- J-2.1.13 Extinction of fires by closing the doors and windows is not likely in the case of industrial buildings because of their large size, where sufficient air to sustain the fire at least in the initial stages can be expected to be present.
- J-2.1.14 Of the two types of building ventilation, namely, vertical and horizontal, vertical ventilation is the one commonly adopted in the case of single storey industrial buildings.
- J-2.1.15 Since 70 to 80 percent of heat produced in a fire is convective heat, the ventilation system has to be suitably designed to ensure early outflow of the heat and thereby minimise fire spread.
- J-2.1.16 Combustible roof linings shall be avoided, as they themselves will contribute to the spread of fire, thereby multiplying the venting problems.
- J-2.1.17 A wind blowing across a flat roof or a roof with a pitch under 40° produces a negative pressure, that is, it tends to draw gases out of the building and so aids venting of hot gases. Wind blowing across a roof of pitch greater than 40° will draw gases out on the leeward side but oppose outward flow on the windward side of the roof.
- J-2.1.18 For vents to work at full efficiency, the area of the inlets for cold air entering the compartment must equal at least the total area of the vents. Ideally, the inlets shall be as close to the ground as possible.
- J-2.1.19 Where roof vents are installed in a single storey building any neighbouring buildings, particularly those of more than one storey, will be subject to some degree of exposure hazard either from flying birds or radiation, or both, as a result.
- J-2.1.20 If vents are to be installed, the size, design, number and disposition of the vents and the associated roof screens/curtain boards have to be assessed after careful analysis of the various factors stated under J-2.1.11, as well as other related factors like type of building construction, nature and height of roof, process hazards, exposure hazard, etc.

## **J-2.2 Venting Area**

- J-2.2.1 The estimated requirements for ventilation are largely based on the assumed build-up of the fire from the time of initial outbreak to the time of effective firefighting action by fire brigade.
- J-2.2.2 The vent area required to be provided shall be approximately proportional to the perimeter of the fire area, because the entrained air forms the bulk of the vented gases.
- J-2.2.3 The effective area shall be the minimum cross-sectional area through which the hot gases must flow out to the atmosphere.
- J-2.2.4 No consideration shall be given to the increased air movement obtained by power operated fans, since it must be assumed that in the event of fire, power will be interrupted, or fans damaged by heat.
- J-2.2.5 The total vent areas to be provided shall be as per the following ratios of effective area of vent openings to floor area for various occupancy classifications indicated:
  - a) Low heat release content - 1: 150 (Sub-division G-1)
  - b) Moderate heat release - 1: 100 contents (Sub-division G-2)
  - c) High heat release - 1: 30 to 1: 50 contents (Sub-division G-3)

## **J-2.3 Types of Vents**

- J-2.3.1 Venting shall be accomplished by any of the types such as monitors continuous gravity vents, until type vents or sawtooth roof skylights.
- J-2.3.2 Where monitor type vents are installed, wire glass or metal panels shall be used only if the sash is arranged to open automatically.
- J-2.3.3 The use of plain thin glass for venting shall be avoided on account of its unpredictable behaviour during fire. However, if glass or other suitable plastic sheet materials with early disintegration characteristics are used, they should be designed for automatic operation.

- J-2.3.4 Where monitors or unit type vents are used, the panels shall be hinged at the bottom and designed to open automatically. Both sides of the vents shall be designed to vent simultaneously to ensure that their effectiveness at the time of fire is not in any way impeded by wind direction.
- J-2.3.5 Where movable shutters are provided for continuous gravity vents, these shall open automatically in the event of fire.
- J-2.3.6 Unit type vents shall be of relatively small area, ranging between 1 m<sup>2</sup> and 9 m<sup>2</sup>, having light weight metal frames and housing with hinged dampers which shall be designed for both manual and automatic operation.
- J-2.3.7 Sawtooth roof skylight shall be considered as satisfactory for venting purposes only when designed for automatic operation.
- J-2.3.8 Likewise, exterior wall windows shall not be reckoned as satisfactory means for venting of fire gases and smoke in industrial buildings. However, they may be reckoned as additional means of venting when, they are located close to the eaves and are provided with ordinary glass or movable sash arranged for both manual and automatic operation.
- J-2.3.9 Baffles shall not be installed inside vents, as they greatly reduce the effective area for venting.

#### **J-2.4 Vent Operation**

- J-2.4.1 The vents shall be automatic in operation, unless where specified in these provisions that they shall be designed for both manual and automatic operation.
- J-2.4.2 The release mechanism shall be simple for operation and independent of electrical power, since electrical services may be interrupted by fire.
- J-2.4.3 The automatic operation of vents shall be achieved by actuation of fusible links or other types of heat and smoke detectors, or by interlocking with operation of sprinkler system or any other automatic fire extinguishing system covering the area. Following their release, the vents shall be designed to open by a system of counterweights and associated equipment utilizing the force of gravity or spring loaded levers.
- J-2.4.4 Automatic fire alarm system, where installed, shall be coupled to the automatic vents to ensure simultaneous operation.
- J-2.4.5 Automatic sprinklers, where installed, shall operate before the vents open order to avoid any likely delay in sprinkler operation. However, heat actuated devices used for vent release shall be suitably shielded from sprinkler discharge so that water does not delay their action. Further, provision of operating the vents manually may also be provided.
- J-2.4.6 Premises where height of roof apex is 10 m or more or where the materials handled or stored have high smoke producing characteristics, in addition to fusible links, the vent release mechanism shall be interlinked to smoke actuated automatic fire detectors to ensure early operation of vents.
- J-2.4.7 Non-corrosive materials shall be used for hinges, hatches and other related parts to ensure long fail-safe operation of the vents.
- J-2.4.8 In case of any doubts regarding the types of vents required to be installed for any particular occupancy, authorities having jurisdiction shall be consulted.

#### **J-2.5 Size, Spacing and Disposition of Vents**

- J-2.5.1 Vents shall be correctly sited to ensure their functional efficiency. Ideally, they shall be sited at the highest point in each area to be covered.
- J-2.5.2 They shall, as far as possible, be located immediately above the risk to be protected so as to allow free and speedy removal of smoke and other combustion products in the event of fire.
- J-2.5.3 The minimum dimension for an effective vent opening shall be not less than 1.25 m in any direction.
- J-2.5.4 The spacing of the individual vent shall be based on the principle that more number of well distributed smaller vents are more effective than fewer number of badly located larger vents.

- J-2.5.5 The maximum spacing between vents for the three occupancy classifications shall be as follows:
- Low heat release : 45 m between centres content
  - Moderate heat : 36 to 37 m between release content centres
  - High heat release : 22.5 to 30 m between content centres, depending on the severity of fire potential.
- J-2.5.6 Vents shall be placed in a sheltered situation where advantage can be taken of the prevailing wind. The design of the vent shall be such as to produce a suction effect. A wind blowing across a flat roof or one with a pitch of 40° produces a negative pressure, that is, it tends to draw gases out of the building and so aids venting of hot gases. Wind blowing across a roof of pitch greater than 40° will draw gases out of the leeward side, but oppose outward flow on the windward side of the roof.
- J-2.5.7 Low level inlets, with total area not less than the total area of vents, shall be provided to permit outside air to be drawn in to aid automatic venting. These inlets, which may be in the form of doors, windows or such other openings, shall be designed for manual operation when desired.

### **J-2.6 Roof Screens or Curtain Boards**

- J-2.6.1 Industrial buildings with large areas and having no subdivision/separating walls limiting the area of individual compartments to 750 m<sup>2</sup> or less, shall be provided with roof screens or curtain boards.
- These screens which extend from the roof downwards at specific intervals not only prevent lateral spread of heat and smoke in the event of fire below, but substantially assist in early operation of automatic sprinklers and vents.
- J-2.6.2 They shall be of sheet metal or any other substantially non-combustible material strong enough to withstand damage by heat or impact.
- J-2.6.3 They shall be reasonably gas-tight, although small openings for passage of pipes, conduits, etc, shall be permitted.
- J-2.6.4 They shall extend down from the roof/ceiling for a minimum depth of 2.2 m. Around specific hazards, the depth shall be 4 m. Where roof/ceiling height exceeds 15 m they shall extend down to within 3 m of the floor. For pitched saw-toothed roofs, they shall extend down to truss level dividing the roof into compartments.
- J-2.6.5 In moderate hazard occupancies, the distance between the screens/curtain boards shall not exceed 75 m and the curtained areas shall be limited to a maximum of 4500 m<sup>2</sup>.
- J-2.6.6 In high hazard occupancies, the distance between screens shall not exceed 30 m and the curtained area shall be limited to 750 m<sup>2</sup>.
- J-2.6.7 The curtained roof area shall be so arranged that they effectively aid in the venting of smoke and hot gases through the automatic vents provided in each area.
- J-2.6.8 In sprinklered buildings, the screens shall preferably be so located as to coincide with the individual sprinkler system areas.

### **J-3 Explosion Relief Vents**

- J-3.1 Industrial premises where combustible dusts can accumulate or where flammable gases, vapours or mists in explosive concentrations may be present are constantly exposed to explosion hazards. Pressures developed by such explosions may be of the order of  $7 \times 10^5$  Pa and ordinary buildings will not be able to withstand the shock of such pressures. Hence, such buildings require explosion relief vents for preventing structural damage.

#### **J-3.2 Basic Principle/Considerations**

- J-3.2.1 Most ordinary building walls will not withstand a sustained internal pressure as great as  $6.9 \times 10^3$  Pa. Hence, explosion relief vents for buildings must be designed to operate at pressures well below those at which the building walls will fail.
- J-3.2.2 There is a rise in pressure during an explosion within an enclosure even with open, unobstructed vents, and any delay in opening the venting devices increases that pressure.

- J-3.2.3 Structural damage can be minimised by locating hazardous operations or equipment outside buildings and cut-off from other operations by a pressure resisting wall. Such isolated processes or equipment shall be housed in single-storey buildings properly vented and a device provided at the inlet of the collector which will prevent an explosion from blowing back through the duct work and into the building.
- J-3.2.4 Where highly hazardous operations cannot be located outside of main buildings, they shall be segregated by pressure resisting walls and each such unit shall be ventilated outdoors. External walls may be of heavy construction, if equipped with suitable vents or high weight panels which blow out easily.
- J-3.2.5 Operations or equipment involving explosion hazards shall not be permitted in basements or areas partially below grade.
- J-3.2.6 Fire can be expected to follow an explosion in most occupancies, so that any fixed fire extinguishing equipment, like sprinklers, if installed, shall be such that only the minimum damage is caused to it.
- J-3.2.7 For a given material, the finer the particle size of the dust, the more violent is the explosion. Some materials, such as aluminium powder, hydrogen, and acetylene, are difficult to vent effectively due to the rapid rate of pressure rise. Some slow burning materials, such as coal dust in a confined space, may do much damage because of the longer duration of their presence. Some dusts, such as magnesium, titanium and zirconium and several metal hydrides may react with and ignite in some common inert gases, such as nitrogen and carbon dioxide.
- J-3.2.8 The maximum explosion pressure in a vented structure decreases as the size of the vent increases but is independent of the rupturing pressure of a diaphragm.
- J-3.2.9 The most effective vent for the release of explosion pressures is an unobstructed vent opening.
- J-3.2.10 Pressure required to rupture diaphragms of the same area and material directly varies with the thickness of the material.
- J-3.2.11 The slower the rate of pressure rise, the more easily can the explosion be vented.
- J-3.2.12 The degree of venting required is directly proportional to the degree of explosion hazard.
- J-3.2.13 Experience has shown that most explosions of dusts, vapours and gases do not involve a large part of the total volume of the enclosure, and frequently occur near the upper or lower limits of the explosive range. Consequently, such explosions are relatively weak compared with the optimum.
- J-3.2.14 Rectangular unrestricted vents areas effective as square vents of equal area.

### **J-3.3 Types of Explosion Relief Vents**

- J-3.3.1 The explosion relief vents shall be any one or more of the following types, depending on individual requirements as assessed by the Authority. Open or unobstructed vents, louvres, open roof vents, hanger type doors, building doors, windows, roof or wall panels or movable fixed sash.
- J-3.3.2 The effect of external wind pressure or suction on these devices shall be taken into consideration while designing and selecting the type of vents, since wind pressures may reach over  $2 \times 10^5$  Pa in severe wind storms.
- J-3.3.3 The type of vent for explosion relief for any occupancy shall be selected with life safety as the primary aim followed by minimum damage to property.
- J-3.3.4 Where large hanger type doors of metal curtain doors inside walls are used as vents, care shall be taken to ensure that they are kept wide open during operations.
- J-3.3.5 Where weather hoods are used to cover roof vents, they shall be as light as possible and lightly attached so as to enable them to be blown off quickly when an explosion occurs.
- J-3.3.6 Doors and windows when used as explosion vents shall be installed to swing outwards. Doors shall have friction, spring or magnetic latches that will function automatically to permit the door to open under slight internal pressure.
- J-3.3.7 Movable sash shall be of the top or bottom hinged or protected type. These shall be equipped with a latch or friction device to prevent accidental opening due to wind action or intrusion. Such latches or locks shall be well maintained.

- J-3.3.8 Fixed sash shall be set in place with very light wall anchorages, or, if tight, shall be securely fitted and glazed with plastic panes in plastic putty.
- J-3.3.9 Where the process is such that the whole of a building or a room may be desirable to arrange for a lightly constructed wall or roof to collapse and thus avert the worst effects of an explosion.

#### **J-3.4 Design, Size and Disposition of Vents**

- J-3.4.1 The required area of explosion vents shall ordinarily depend on the expected maximum intensity of an explosion in the occupancy, the strength of the structure, the type of vent closure and other factors.
- J-3.4.2 Venting shall be planned in such a manner as to prevent injury to personnel and damage to exposure. In congested locations, substantial ducts or diverters shall be provided to direct the blast.
- J-3.4.3 When ductwork is used, the ducts shall be of sufficient strength to withstand the maximum expected explosion pressure.
- J-3.4.4 Where explosions are likely within duct and piping systems, they shall be vented by the use of suitable diaphragms designed to blow out at a predetermined pressure. There shall be no physical connection between ductwork system for more than one collector.
- J-3.4.5 In large structures, the position of vents shall be relative to the point of origin of explosion, when it can be determined.
- J-3.4.6 Where relatively slow explosions involving coal dust, chlorinated solvents, etc, are involved, light, hinged swinging panels may be preferred to diaphragm type of vents.
- J-3.4.7 Obstructions of any kind blocking the vents from the risk covered shall be avoided, particularly where risks of rapid violent explosions are present.
- J-3.4.8 Counterweights add to the inertia of the vents and so shall be avoided.
- J-3.4.9 Various relieving devices, including devices actuated by detonators, shall start to open at as low a pressure as possible. They shall be of light construction, so that full opening can be quickly attained.
- J-3.4.10 Vents shall be of such size and design as to prevent rupture of the protected device or apparatus.
- J-3.4.11 Skylights or monitors with movable sash that will open outwards, or fixed sash containing panes of glass or plastic that will blow out readily under pressure from within, can be used to supplement wall vents or windows, provided resistance to their displacement or opening is kept as low as consistent with the requirements for structural strength.
- J-3.4.12 Flexible plastic sheets when used for vent closures shall be installed in slotted frames in such a way that pressure from within bulges the sheets and releases them from the holding frame.
- J-3.4.13 Fragile sheets made of plastic, when used for vent closures, shall be thin sheets that will crack or rupture under less pressure than single strength glass. For this reason use of transparent or translucent plastic sheets is more advantageous than use of glass in window sash.
- J-3.4.14 If closed vents are used they shall be larger in area than unenclosed vents to provide equivalent explosion pressure relief.
- J-3.4.15 Small enclosures, such as machines, shall be vented more generously than buildings, because if an explosion occurs in a machine, its entire volume may be involved.
- J-3.4.16 Vents for the protection of buildings and equipment shall be installed on the following basis:
  - 1 Small enclosures of less than 30 m<sup>3</sup>, machines and ovens of light construction: 1000 cm<sup>2</sup> for each 0.3 m<sup>3</sup> to 0.9 m<sup>3</sup>.
  - 2 For small enclosures of more substantial construction having reasonably high bursting strength: 1000 cm<sup>2</sup> for each 0.9 m<sup>3</sup>.
  - 3 Fairly large enclosures of 30 to 700 m<sup>3</sup>, such as bins, silos, rooms, storage tanks, etc: 1000 cm<sup>2</sup> for each 0.9 m<sup>3</sup> to 1.5 m<sup>3</sup>. In these cases, attempt shall be made to the extent possible to predict the likely point of origin of the explosion in relation to the vent.

- 4 Large rooms and buildings over 700 m<sup>3</sup> containing hazardous equipment comprising a small fraction of the entire volume:
  - a) For heavy reinforced concrete, walls: 100 cm<sup>2</sup> for each 2.25 m<sup>3</sup>.
  - b) For light reinforced concrete, brick or wood construction: 1000 cm<sup>2</sup> for each 1.65 m<sup>3</sup> to 2.25 m<sup>3</sup>.
  - c) For lightweight construction such as prefabricated panels: 1000 cm<sup>2</sup> for each 1.5 m<sup>3</sup> to 1.65 m<sup>3</sup>.
- 5 Large rooms or building over 700 m<sup>3</sup> containing hazardous equipment comprising a large part of the entire volume of a room or building shall be vented as generously as possible: 1000 cm<sup>2</sup> for each 0.3 m<sup>3</sup> to 1.05 m<sup>3</sup>.
- 6 In order to obtain these ratios, the size of the building or room must be limited. For some hazardous materials, such as hydrogen, acetylene, carbon disulphide, etc, these limits are extremely low.
- 7 Emphasis shall always be placed on segregating hazardous areas by means of firewalls or separating walls to prevent spread of fire.
- 8 Interior walls of light construction, such as tile, shall be avoided in hazardous locations, since they can cause injuries to personnel in the event of an explosion.

## Annexure K

### LIST OF STANDARDS

The following list records those standards which are acceptable as good practice and accepted standards in the fulfilment of the requirements of the Rule. The latest version of a standard shall be adopted at the time of enforcement of the Rule. The standards listed may be used by the Authority for conformance with the requirements of the referred clauses in the Rule. In the following list, the number appearing in the first column within parentheses indicates the number of the reference in this Part.

Table No. AK-1 –: List of IS Codes and Titles

No.	IS No.	Title
1	3808: 1979	Method of test for non-combustibility of building materials (first revision)
2	IS/ISO 834-1 1999	Fire resistance tests - Elements of building construction Part 1 General Requirements
	IS/ISO 834-4 2000	Fire resistance tests - Elements of building construction: Part 4 Specific requirements for load bearing vertical separating elements
	IS/ISO 834-5 2000	Fire resistance tests - Elements of building construction: Part 5 Specific requirements for load bearing horizontal separating elements
	IS/ISO 834-6 2000	Fire resistance tests - Elements of building constructions: Part 6 Specific requirements for beams
	IS/ISO 834-7 2000	Fire resistance tests - Elements of building construction: Part 7 Specific requirements for columns
	IS/ISO 834-8 2003	Fire resistance tests - Elements of building construction: Part 8 Specific requirements for non-load bearing vertical separating elements
	IS/ISO 834-9 2003	Fire resistance tests – Elements of building construction: Part 9 Specific requirements for non-load bearing ceiling elements
3	8757:1999	Glossary of terms associated with fire safety (first revision)
	7673:2004	Glossary of terms for fire fighting equipment (first revision)
4	8758 : 2013	Code of practice for fire precautionary measures in construction of structures and pandals (second revision)
5	9668 : 1990	Code of practice for provision and maintenance of water supplies and fire fighting
	3844 : 1989	Code of practice for installation and maintenance of internal fire hydrants and hose reels on premises (first revision)
6	1646 : 2015	Code of practice for fire safety of buildings (general) : Electrical installations (third revision)
7	9457 : 2005	Code of practice for safety colours and safety signs (first revision)
	12349 : 1988	Fire protection - Safety sign
	12407 : 1988	Graphic symbols for fire protection plans
8	11360 : 1985	Specification for smoke detectors for use in automatic electrical fire alarm system
9	655 : 2006	Specification for air ducts
10	1649 : 1962	Code of practice for design and construction of flues and chimneys for domestic heating appliances (first revision)
	1642 : 2013	Code of practice for safety of buildings (general): Details of construction (second revision)
11	12777 : 1989	Method for classification of flame spread of products
12	1642 : 2013	Code of practice for safety of buildings (general): Details of Construction (second revision)
13	16246 : 2015	Elastomer insulated cables with limited circuit Integrity when affected by fire-Specification
14	6044 (Part 1): 2013	Liquefied petroleum gas storage installations - Code of Practice : Part 1 Residential commercial and industrial cylinder installations
	6044 (Part 2): 2001	Code of Practice for liquefied petroleum gas storage Installations: Part 2 Commercial, industrial and domestic bulk storage installations



No.	IS No.	Title
15	2175 : 1988	Specification for heat sensitive fire detectors for use in automatic fire alarm system (second revision)
	IS/ISO 7240-5 : 2003	Fire detection and alarm systems: Part 5 Point-type heat detectors
	IS/ISO 7240-7 : 2011	Fire detection and alarm systems: Part 7 Point-type smoke detectors using scattered light, transmitted light or ionization.
	IS/ISO7240-11 : 2011	Fire detection and alarm systems: Part 11 Manual call points
	IS/ISO 7240-15 : 2004	Fire detection and alarm systems: Part 15 Point-type fire detectors
	11360 : 1985	Specification for smoke detectors for use in automatic electrical fire alarm system
16	2189 :2008	Code of practice for selection, installation, and maintenance of automatic fire detection and alarm system (second revision)
17	636 : 1988	Specification for non-percolating flexible firefighting delivery hose (third revision)
	884 : 1985	Specification for first-aid hose reel for fire fighting(first revision)
	901 : 1988	Specification for couplings, double male and double female instantaneous pattern for fire fighting (third revision)
	902 : 1992	Specification for suction hose couplings for fire fighting purposes (third revision)
	903 : 1993	Specification for fire hose delivery couplings, branch pipe, nozzles and nozzle spanner (fourth revision)
	904 : 1983	Specification for two-way and three-way suction collecting heads for fire fighting purposes (second revision)
	905 : 1980	Specification for delivery breechings, dividing and collecting, instantaneous pattern for fire fighting purposes (second revision)
	906 : 1988	Specification for revolving branch pipe for fire fighting (third revision)
	907 : 1984	Specification for suction strainers, cylindrical type for fire fighting purpose (second revision)
	908 : 1975	Specification for fire hydrant, stand post type (second revision)
	909 : 1992	Specification for underground fire hydrant : Sluice valve type (third revision)
	910 : 1980	Specification for combined key for hydrant, hydrant cover and lower valve (second revision)
	926 : 1985	Specification for fireman's axe (second revision)
	927 : 1981	Specification for fire hooks (second revision)
	928 : 1984	Specification for fire bells (second revision)
	937 : 1981	Specification for washers for water fittings for fire fighting purposes (second revision)
	939 : 1977	Specification for snatch block for use with fibre rope for fire brigade use (first revision)
	941: 1985	Specification for blowers and exhauster for fire fighting (second revision)
	942 : 1982	Functional requirements for 275 l/min portable pump set for fire fighting (second revision)
	943 : 1979	Functional requirement for 680 l/min trailer pump for fire brigade use (second revision)
	944 : 1979	Functional requirement for 1800 l/min trailer pump for fire brigade use (second revision)
	947 : 1985	Functional requirement for towing tender for trailer fire pump for fire brigade use (first revision)
	948 : 1983	Functional requirement for water tender, Type A, for fire brigade use (second revision)
	949 : 2012	Functional requirement for emergency (rescue) tender (third revision)
	950 : 2012	Functional requirements for water tender, Type B for fire brigade use (third revision)
	952 : 1986	Specification for fog nozzle for fire brigade use (second revision)
	955 : 1980	Functional requirements for dry power tender for fire-brigade use (150 kg capacity) (first revision)
957 : 1967	Specification for control van for fire brigade	

No.	IS No.	Title
	1941 (Part 1) : 1976	Functional requirements for electric motor sirens : Part 1 AC, 3-Phase, 50 Hz, 415 volts type (second revision)
	2097 : 2012	Specification for foam making branch pipe and foam inductor (second revision)
	2175 : 1988	Specification for heat sensitive fire detectors for use in automatic detectors for use in automatic fire alarm system (second revision)
	2546 : 1974	Specification for galvanized mild steel fire bucket (first revision)
	2696 : 1974	Functional requirements for 1125 l/min light fire engine (first revision)
	2745 : 1983	Specification for non-metal helmet for firemen and civil defence personnel (second revision)
	2871 : 2012	Specification for branch pipe, universal for fire fighting purposes (second revision)
	2878 : 2004	Specification for fire extinguisher, carbon-dioxide type (portable and trolley mounted) (third revision)
	2930 : 1980	Functional requirements for hose laying tender for fire brigade use (first revision)
	3582 : 1984	Specification for basket strainers for fire fighting purposes (cylindrical type) (first revision)
	4308 : 2003	Specification for dry chemical powder for fire fighting B and C class fires (second revision)
	4571 : 1977	Specification for aluminium extension ladders for fire brigade use (first revision)
	4643 : 1984	Specification for suction wrenches for fire brigade use (first revision)
	4861 : 1984	Specification for dry powder for fighting fires in burning metals (first revision)
	4927 : 1992	Specification for unlined flax canvas hose for fire fighting (first revision)
	4928 : 1986	Specification for delivery valve for centrifugal pump outlets (first revision)
	4947 : 2006	Specification for gas cartridges for use in fire extinguishers (third revision)
	4989 : 2006	Foam concentrate for producing mechanical foam for fire fighting - Specification (third revision)
	4989 (Part 4) : 2003	Specification for multipurpose aqueous film forming foam liquid concentrate for extinguishing hydrocarbon and polar solvent fires
	5131 : 2002	Specification for dividing breeching with control, for fire brigade use (second revision)
	5290 : 1993	Specification for landing valve (third revision)
	5486 : 1985	Specification for quick release knife (first revision)
	5505 : 1985	Specification for multi-edged rescue axe (non-wedging) (first revision)
	5612	Specification for hose-clamps and hose-bandages for fire brigade use
	(Part 1) : 1977	Hose clamps (first revision)
	(Part 2) : 1977	Hose bandages (first revision)
	5714 : 1981	Specification for hydrant, standpipe for fire fighting (first revision)
	6026 : 1985	Specification for hand operated sirens (first revision)
	6067 : 1983	Functional requirements for water tender, Type 'X' for fire brigade use ( first revision)
	IS/ISO 7240-5 : 2003	Fire detection and alarm systems - Part 5: Point-type heat detectors
	IS/ISO 7240-7 : 2011	Fire detection and alarm systems - Part 7: Point-type smoke detectors using scattered light, transmitted light or ionization
	IS/ISO 7240-11 : 2011	Fire detection and alarm systems Part 11 Manual call points
	8090 : 1992	Specification for couplings, branch pipe, nozzle, used in hose reel tubing for fire fighting (first revision)
	8096 : 1992	Specification for fire beaters (first revision)
	8149 : 1994	Functional requirements for twin CO2 fire extinguishers (trolley mounted) (first revision)
	8423 : 1994	Specification for controlled percolating hose for fire fighting (first revision)
	8442 : 2008	Specification for stand post type water and foam monitor for fire fighting (first revision)
	9972 : 2002	Specification for automatic sprinkler heads (first revision)

No.	IS No.	Title
	10460 : 1983	Functional requirements for small foam tender for fire brigade use
	10658 : 1999	Specification for higher capacity dry powder fire extinguisher (trolley mounted) (first revision)
	10993 : 1984	Functional requirements for 2 000 kg dry powder tender for fire brigade use
	11101 : 1984	Specification for extended branch pipe for fire brigade use
	11108 : 1984	Specification for portable fire extinguisher halon-1211 type
	11833 : 1986	Specification for dry powder fire extinguisher for metal fires
	12717 : 1989	Functional requirements of fire fighting equipment - High capacity portable pumpset (1 100-1 600 l/min)
	12796 : 1989	Specification for fire rake
	13039 : 1991	Code of practice for provision and maintenance of external hydrant system
	13385 : 1992	Specification for fire extinguisher 50 capacity wheel mounted water type (Gas cartridge)
	13386 : 1992	Specification for 50 litre capacity fire extinguisher, mechanical foam type
	14609 : 1999	Specification for ABC dry powder for fire fighting
	14933 : 2001	Specification for high pressure fire fighting hose
	14951 : 2001	Specification for fire extinguisher, 135 litre capacity mechanical foam type
	15051 : 2002	Specification for high pressure fire hose delivery couplings
	IS 15105 : 2002 / ISO 6182-1	Design and installation of fixed automatic sprinkler fire extinguishing system
	IS 15220 : 2002 ISO 7201-1	Specification for halon 1211 and halon 1301 — fire extinguishing media for fire protection
	IS 15683 : 2006 / ISO 7165 : 2009	Portable fire extinguishers - Performance and construction – Specification
	11360 : 1985	Specification for smoke detectors for use in automatic electrical fire alarm system
	IS 15493 : 2004 / ISO 14520-1	Gaseous fire extinguishing systems : General requirements
	IS 15505 : 2004 / ISO 14520-6	Gaseous fire extinguishing systems: HCFC Blend A extinguishing systems
	IS 15506 : 2004 / ISO 14520-14	Gaseous fire extinguishing systems : IG 55 extinguishing systems
	IS 15525 : 2004 / ISO 14520-13	Gaseous fire extinguishing systems : IG 100 extinguishing systems
	IS 15501 :2004 / ISO 14520-15	Gaseous fire extinguishing systems - IG 541 extinguishing systems
	IS 15497 : 2004 / ISO 14520-12	Gaseous fire extinguishing systems - IG 01 extinguishing systems
	15519 : 2004	Code of practice for water mist fire protection systems - System design, installation and commissioning
	IS 15517 : 2004 / ISO 14520-9	Gaseous fire extinguishing systems : Carbon dioxide, total flooding and local application including in cabinet subfloors systems
	IS 15517 : 2004 / ISO 14520-9	Gaseous fire extinguishing systems - HFC 227ea (Hepta Fluoro Propane) extinguishing system
18	2190 : 2010	Code of practice for selection, installation and maintenance of portable first aid fire extinguishers (fourth revision)
19	884 : 1985	Specification for first aid hose reel for fire fighting (first revision)
20	15105 : 2002	Design and installation of fixed automatic sprinkler fire extinguishing system
21	15325 : 2003	Design and installation of fixed automatic high and medium velocity water spray system -Code of practice
22	12835 (Part 1) : 1989	Design and installation of fixed foam fire extinguishing system - Code of practice: Part 1 Low expansion foam
23	15528 : 2004	Gaseous fire extinguishing systems - Carbon dioxide, total flooding and local application (sub-floor and in-cabinet), high and low floor pressure (refrigerated) systems
24	15519 : 2004	Water mist fire protection systems — System design, installation and commissioning — Code of Practice
25	15493 : 2004	Gaseous fire extinguishing Systems — General requirements

No.	IS No.	Title
	15497 : 2004	Gaseous fire extinguishing systems — IG 01 extinguishing systems
	15501 : 2004	Gaseous fire extinguishing systems — IG 541 extinguishing systems
	15505 : 2004	Gaseous fire extinguishing systems — HCFC Blend A
	15506 : 2004	Gaseous fire extinguishing systems — IG 55 extinguishing systems
	15517 : 2004	Gaseous fire extinguishing systems — HFC 227 ea (Hepta fluoro propane) extinguishing systems
	15525 : 2004	Gaseous fire extinguishing systems — IG 100 extinguishing systems
26	2189 : 2008	Code of practice for selection, installation and maintenance of automatic fire detection and alarm system (fourth revision)
	2190 : 2010	Code of practice for selection, installation and maintenance of portable first aid fire extinguishers (fourth revision)
	3844 : 1989	Code of practice for installation and maintenance of internal fire hydrants and hose reels on premises (first revision)
	9668 : 1990	Code of practice for provision and maintenance of water supplies for fire fighting
	13039 : 1991	Code of practice for provision and maintenance of external hydrant system
	13039 : 2014	External hydrant systems - Provision and maintenance - Code of practice
27	4878 : 1986	Byelaws for construction of cinema buildings (first revision)
28	2726 : 1988	Code of practice for fire safety of industrial buildings : Cotton ginning and pressing (including cotton seed delinting) factories (first revision)
	3034 : 1993	Code of practice for fire safety of industrial buildings : Electrical generating and distributing stations (second revision)
	3058 : 1990	Code of practice for fire safety of industrial buildings : Viscose rayon yarn and/or staple fibre plants (first revision)
	3079 : 1990	Code of practice for fire safety of industrial buildings : Cotton textile mills (first revision)
	3594: 1991	Code of practice for fire safety of industrial buildings : General storage and warehousing including cold storage (first revision)
	3595: 1984	Code of practice for fire safety of industrial buildings : Coal pulverizers and associated equipment (first revision)
	3836 : 2000	Code of practice for fire safety of industrial buildings : Jute mills (second revision)
	4209 : 2013	Code of safety for chemical laboratories (second revision)
	4226 : 1988	Code of practice for fire safety of industrial buildings : Aluminium/ Magnesium powder factories (first revision)
	4886 : 1991	Code of practice for fire safety of industrial buildings : Tea factories (first revision)
	6329 : 2000	Code of practice for fire safety of industrial buildings : Saw mills and wood works (first revision)
	9109 : 2000	Code of practice for fire safety of industrial buildings : Paint and Varnish factories
	11457 (Part 1) : 1985	Code of practice for fire safety of chemical industries: Part 1 Rubber and plastic
29	13039 : 2014	External hydrant systems - Provision and maintenance - Code of practice

