

Draft General Development Rules 2023 for Daman District of Union Territory of Dadra and Nagar Haveli and Daman and Diu

PART 3 (I)

**Framed under Section 30, 140 (y) & (2) and 141 of
The Dadra and Nagar Haveli and Daman and Diu Town & Country Planning Act,
1974 (Amended from time to time).**

**Daman Planning and Development Authority
Union Territory Administration of Dadra and Nagar Haveli, Daman & Diu**

Draft General Development Rules 2023 for Daman District of Union Territory of Dadra and Nagar Haveli and Daman and Diu

PART 3 (I)

**Framed under Section 30, 140 (y) and 141 of
The Dadra and Nagar Haveli and Daman and Diu Town & Country
Planning Act, 1974 (Amended from time to time).**

**Daman Planning and Development Authority
Union Territory Administration of Dadra and Nagar Haveli,
Daman & Diu**

Draft General Development Rules 2023 for Daman District of Union Territory for Dadra and Nagar Haveli and Daman and Diu

*Framed under Section 30, 140 (y) and 141 of
The Dadra and Nagar Haveli and Daman and Diu Town & Country Planning Act, 1974
(Amended 20 April 2022).*

In exercise of powers conferred by Section 30, 140 (y) and 141 of the – Dadra and Nagar Haveli and Daman and Diu Town & Country Planning Act, 1974 (amended from time to time) and all other powers enabling him in that behalf, the Administrator Dadra and Nagar Haveli and Daman and Diu hereby makes the following Rules in consonance with the Outline Development Plans for Daman Districts of Union Territory for Dadra and Nagar Haveli and Daman and Diu.

Part A Administrative and Procedure Rules

Part A Administrative and Procedure Rules

1 Short Title, Commencement, Applicability, Repeal and Savings

2 Definitions

- 2.1 Access
- 2.2 Accessory Building
- 2.3 Accessory Use
- 2.4 Act
- 2.5 Addition and/or alterations
- 2.6 Advertising Display Infrastructure / Advertising Sign, billboards, and Hoarding
- 2.7 Air-conditioning
- 2.8 Amenities
- 2.9 Apartment/ Flat
- 2.10 Application
- 2.11 Approved
- 2.12 Associate Town Planner
- 2.13 Atrium
- 2.14 Authorized Officer
- 2.15 Authority
- 2.16 Banquet Hall
- 2.17 Basement
- 2.18 Build to Line
- 2.19 Building
- 2.20 Building Unit / Plot
- 2.21 Built Unit / Plot Depth
- 2.22 Built up Area
- 2.23 Built up Area, Carpet
- 2.24 Built up Area, Dwelling Unit
- 2.25 Cabin
- 2.26 Canopy
- 2.27 Chairman PDA
- 2.28 Chawl
- 2.29 Chhajja/Weather Shed
- 2.30 Chief Officer
- 2.31 Chimney
- 2.32 Chowk
- 2.33 Cold Storage
- 2.34 Collector
- 2.35 Competent Authority
- 2.36 Common Plot
- 2.37 Community Hall
- 2.38 Construction
- 2.39 Contiguous Holding
- 2.40 Conversion
- 2.41 Cornice
- 2.42 Corridor
- 2.43 Council or Municipal Council
- 2.44 Courtyard
- 2.45 Density

- 2.46 Developer
- 2.47 Development Permission
- 2.48 Dharamshala
- 2.49 Domestic Wastewater
- 2.50 Drain / Drainage System
- 2.51 Dwelling Unit
- 2.52 Enclosed Staircase
- 2.53 Escalator
- 2.54 Escape Route
- 2.55 External Wall
- 2.56 Existing Development / Building / Use
- 2.57 Farmhouse
- 2.58 Floor
- 2.59 Floor Area
- 2.60 Floor Space Index (FSI) or Floor Area Ratio (FAR)
- 2.61 Footing
- 2.62 Foundation
- 2.63 Front
- 2.64 Gaothan or Gamtal
- 2.65 Garage-Private
- 2.66 Garage-Public
- 2.67 Government
- 2.68 Ground Coverage
- 2.69 Ground Level
- 2.70 Habitable Room
- 2.71 Hazardous Material
- 2.72 Height of a Room
- 2.73 Height of building
- 2.74 Home Occupation
- 2.75 Illuminated Exit Signs
- 2.76 Land
- 2.77 Lift/Elevators
- 2.78 Lobby
- 2.79 Loft
- 2.80 Margin
- 2.81 Member Secretary
- 2.82 Mezzanine Floor
- 2.83 Natural Hazard
- 2.84 Natural Hazard Prone
- 2.85 Non- Agriculture Permission
- 2.86 Non-Ambulatory Disabilities
- 2.87 Non-Potable Water
- 2.88 Occupant Load
- 2.89 Open Space
- 2.90 Owner
- 2.91 Parapet
- 2.92 Parking Space
- 2.93 Partition
- 2.94 Persons on Record
- 2.95 Plinth
- 2.96 Pergola

- 2.97 Porch
- 2.98 Premises
- 2.99 Prohibited Industrial Waste
- 2.100 Pre-school
- 2.101 Public Purpose
- 2.102 Renovation and Repair
- 2.103 Rear
- 2.104 Registered Architect / Structural Engineer/ Civil Engineer
- 2.105 Retrofitting
- 2.106 Road / Street
- 2.107 Road / Street – Public
- 2.108 Road / Street level or Grade
- 2.109 Road/ Street Line
- 2.110 Road width or Width of Road/ Street
- 2.111 Row houses
- 2.112 Service Apartment
- 2.113 Service Road
- 2.114 Setback Line
- 2.115 Solid Waste
- 2.116 Sparsh 2.0 Housing
- 2.117 Stair Cabin / Stair Cover / Mumty
- 2.118 Staircase
- 2.119 Stairwell
- 2.120 Storey
- 2.121 Temporary Structure
- 2.122 To Erect
- 2.123 Transferable Development Rights (TDR)
- 2.124 Unauthorised Construction
- 2.125 Use / Occupancy
- 2.126 Ventilation
- 2.127 Warehouse
- 2.128 Waterbody
- 2.129 Water Closet (WC)
- 2.130 Water Course
- 2.131 Wayside Shop
- 2.132 Wholesale Establishment
- 2.133 Window

3 Responsibilities of Owner and / or Developer and Persons on Record

- 3.1 Responsibilities of Owner / Developer
 - 3.1.1 Owner / Developer to Apply for a Development Permission
 - 3.1.2 Responsibilities of Owner or Developer
- 3.2 Registration of Persons on Record (POR)
 - 3.2.1 Registering with the Competent Authority
 - 3.2.2 Minimum Qualifications and Competence Requirements
 - 3.2.3 Registration Fees and Security Deposit
 - 3.2.4 Cancellation of Registration
 - 3.2.5 Penalties
- 3.3 Responsibilities of Individual Persons on Record (POR)
 - 3.3.1 Responsibilities of all POR
 - 3.3.2 Architect on Record (abbreviated as AOR)

- 3.3.3 Civil Engineer on Record (abbreviated as CEOR)
- 3.3.4 Structural Engineer on Record (abbreviated as SEOR)
- 3.3.5 Clerk of Works on Record (abbreviated as COWOR)
- 3.3.6 Supervisor of Works on Record (abbreviated as SOR)
- 3.3.7 Qualified Agency on Record for Fire (abbreviated as QAORF)

4 Development Permission

- 4.1 Development Permission Required
- 4.2 Development Permission Not Required
- 4.3 Grant of a Development Permission
 - 4.3.1 Grant of a Development Permission
 - 4.3.2 Liability
- 4.4 Lapse, Suspension or Cancellation of Development Permission
 - 4.4.1 A Development Permission shall Lapse
 - 4.4.2 A Development Permission shall Stand Suspended
 - 4.4.3 A Development Permission shall Stand Cancelled
 - 4.4.4 General Provisions regarding Lapse, Suspension, or Cancellation of the Development Permission
- 4.5 Revision of Development Permission
- 4.6 Extension / Revalidation of Development Permission
- 4.7 Unauthorized Development
 - 4.7.1 Unauthorized Development
 - 4.7.2 Dealing with Unauthorized Development
 - 4.7.3 Undertaking Unauthorized Development to be a Cognizable Offence
- 4.8 Relaxation, Interpretation and Conflict Resolution Mechanism
 - 4.8.1 Grant of Relaxation
 - 4.8.2 Prescribed Authority to Clarify and Interpret Provisions of the Rules
 - 4.8.3 Conflict Resolution Mechanism and Apples unauthorised development and refusal to grant development permission or occupancy certificate
- 4.9 Penalties
- 4.10 Obtaining Direct Development Permission
 - 4.10.1 Application, Document and Registration
 - 4.10.2 Fees and Charges
 - 4.10.3 Scrutiny of Application, Registration or Cancellation of Direct Development Permission
 - 4.10.4 Penalties
- 4.11 Obtaining Development Permission
 - 4.11.1 Application
 - 4.11.2 Fees and Charges
 - 4.11.3 Scrutiny of Application, Grant, or Refusal of a Development Permission
 - 4.11.4 Penalties
- 4.12 Revising a Direct Development Permission
 - 4.12.1 Application, Documents and Registration
 - 4.12.2 Fees and Charges
 - 4.12.3 Scrutiny of Application, Registration or Refusal of Revised Direct Development Permission
 - 4.12.4 Penalties
- 4.13 Revising a Development Permission
 - 4.13.1 Application
 - 4.13.2 Fees and Charges
 - 4.13.3 Scrutiny of Application, Grant, or Refusal of a Revised Development Permission
 - 4.13.4 Penalties
- 4.14 Revalidating a Lapsed/Suspended Direct Development Permission
 - 4.14.1 Application, Documents and Registration

- 4.14.2 Fees and Charges
- 4.14.3 Scrutiny of Application, Registration or Refusal of Revised Direct Development Permission
- 4.14.4 Penalties
- 4.15 Revalidating a Lapsed/Suspended Development Permission
 - 4.15.1 Application
 - 4.15.2 Fees and Charges
 - 4.15.3 Scrutiny of Application, Grant, or Refusal of a Lapsed Development Permission
 - 4.15.4 Penalties
- 4.16 Temporary Construction Permission
 - 4.16.1 Application
 - 4.16.2 Fees and Charges
 - 4.16.3 Scrutiny of Application, Grant, or Refusal of Permission
 - 4.16.4 Penalties

5 Procedure During Construction

- 5.1 Inspection of Construction
 - 5.1.1 Inspection of Construction at Any Time
 - 5.1.2 Inspection where Development Permission is Issued
 - 5.1.3 Inspection where Development Permission is Granted
 - 5.1.4 Inspection for Fire Safety and Protection of Building under Construction
- 5.2 Information to be Prominently Displayed on Site
- 5.3 Documents and Drawings to be Maintained on Site
- 5.4 Reducing Inconvenience and Ensuring Safety during Construction
 - 5.4.1 Stacking, Storing and Disposal of Building Material
 - 5.4.2 Barricading the Building Unit / Plot during Construction
 - 5.4.3 No Damage or Undue Inconvenience during Construction
 - 5.4.4 Liability for Ensuring during Construction
- 5.5 Progress of Construction and Inspection
 - 5.5.1 Notice for Commencement of Construction
 - 5.5.2 Development Permission may Lapse if Construction Not Commenced on Time
 - 5.5.3 Competent Authority to be Notified of Progress of Construction
- 5.6 Inspections

6 Occupancy Certificate

- 6.1 Occupancy Certificate Required
- 6.2 Grant of Occupancy Certificate
- 6.3 Cancellation of Occupancy Certificate
- 6.4 Unauthorized Use / Occupancy of Building / Development
- 6.5 Obtaining an Occupancy Certificate
 - 6.5.1 Application
 - 6.5.2 Fees and Charges
 - 6.5.3 Final Inspection and Grant / Refusal of Occupancy Certificate
 - 6.5.4 Penalties
- 6.6 Permission to Change Sanctioned Occupancy / Use of Development
 - 6.6.1 Application
 - 6.6.2 Fees
 - 6.6.3 Scrutiny of Application, Grant, Refusal
 - 6.6.4 Penalties

Tables

Table No. 3.1	Registration Fees for Registration as Persons on Record
Table No. 4.1	Fees for Appealing Before Prescribed Authority

Figures

Figure No. 2.1	Atrium Within a Building
Figure No. 2.2	Built to Line for a Building.
Figure No. 2.3	Built up Area, Building.
Figure No. 2.4	Carpet Area
Figure No. 2.5	Built up Area, Dwelling Unit
Figure No. 2.6	Contiguous Holding
Figure No. 2.7	Corridor
Figure No. 2.8	Front
Figure No. 2.9	Height of a Room
Figure No. 2.10	Margins
Figure No. 2.11	Parking Space
Figure No. 2.12	Plinth
Figure No. 2.13	Porch
Figure No. 2.14	Refuge Area
Figure No. 2.15	Setback Line from an Existing Street Not in the ODP/ TPS
Figure No. 2.16	Stair Cabin / Mumty
Figure No. 2.17	Maximum Travel Distance by User to Escape Route.

1.0 Short Title, Commencement, Applicability, Repeal and Savings

- 1.1 These Rules shall be called “General Development Rules 2023” for Union Territory of Dadra & Nagar Haveli, Daman, and Diu.
- 1.2 These Rules shall come into force from the date of publication in the Official Gazette.
- 1.3 These Rules shall apply to the entire territory of Union Territory of Dadra & Nagar Haveli, Daman, and Diu including both Municipality and rural areas.
- 1.4 Notwithstanding anything else contained in any other rule, regulation, byelaw, notification, or order etc, of the UT administrator, any authority including Fire Department, Municipal Councils, Planning and Development Authorities, and CRZ committees, giving any permission required for or related to construction or occupancy of any building shall abide by these Rules.
- 1.5 Notwithstanding anything contained in these Rules:
 - 1 Any modifications or revision or anything done, or any action taken under the rules in force prior to such modification shall be deemed to be valid and continue to be so valid, unless otherwise specified.
 - 2 Removal, alteration, or abandonment, nor prevent continuance of the lawfully established use or occupancy of an existing approved building unless, in the opinion of the Competent Authority such a building is unsafe or constitutes a hazard to the safety of adjacent property or to the occupants of the building itself or endanger to any premises or person adjoining shall not require permission.
 - 3 Any development permission (construction permission) given for which construction has not started shall be required to obtain revised development permission under these Rules.
- 1.6 Notwithstanding the National Building Code or any other code for the time being in force, if there are inconsistencies with the provision of these particular Rules, then these Rules shall supersede, the fire department or any other department shall follow the provision of these Rules.

2.0 Definitions

In these Rules, unless the context otherwise requires, the terms and expressions shall have the meaning indicated against each of them. The terms and expressions not defined in these Rules shall have the same meaning as in The Dadra and Nagar Haveli and Daman and Diu Town & Country Planning Act, 1974 as amended from time to time.

- 2.1 *Access*: A clear approach from the entry into the building unit to building/buildings within-the building unit.
- 2.2 *Accessory Building*: means a building separated from the main building on a building unit / plot which is put to use or is proposed to be put to use for one or more accessory uses.
- 2.3 *Accessory use*: means use of the building subordinate and customarily incidental to the principal use.
- 2.4 *Act*: means the [Dadra and Nagar Haveli and] Daman and Diu Town & Country Planning Act, 1974 as amended from time to time.
- 2.5 *Additions and/or alterations*: means: any change in the proposed or approved use or proposed or approved plan of the building.
- 2.6 *Advertising Display Infrastructure / Advertising Sign, billboards, and Hoarding*: means any surface or structure with characters, letter or illustrations applied thereto and displayed in any manner whatsoever for the purpose of advertising or giving information regarding or to attract the public to any place, person, public performance, article or merchandise, and which surface or structure is attached to, forms part of or is connected, with any building, or is fixed to a tree or to the ground or to any pole, screen, fence or hoarding or displayed in space; or in or over any water body in the jurisdiction of the Competent Authority.
- 2.7 *Air-conditioning*: the process of treating air, so as to control its temperature, humidity or quality to meet the requirements of a conditioned space.
- 2.8 *Amenities*: means roads, streets, open spaces, parks, recreational grounds, playgrounds, gardens, water supply, electric supply, street lighting, drainage, sewerage, public works and

other utilities, communication network, services and conveniences or any other amenity which may be notified by the authority from time to time.

- 2.9 *Apartment / Flat*: means multi storeyed residential buildings constructed in a detached or semi-detached manner designed as ground floor with more upper floors and constructed as separate dwelling units with common staircase.
- 2.10 *Application*: means an application made under these Rules in such form as may be prescribed by the Competent Authority from time to time.
- 2.11 *Approved*: As approved / sanctioned by the Competent Authority under applicable rules, laws or regulations etc.
- 2.12 *Associate Town Planner*: means Town / Urban Planner of the Government of Dadra and Nagar Haveli District, Daman District and Diu District or Chief Town Planner in his / her absence.
- 2.13 *Atrium (Plural Atria)*: A large-volume space created by a floor opening or series of floor openings connecting two or more stories that is covered at the top of the series of openings with a light weight or glazed roof and is used for purposes other than an enclosed stairway; lifts hoist-way; an escalator opening; or as a utility shaft used for plumbing, electrical, air conditioning, or communications facilities. (Refer Figure No. 2.1).

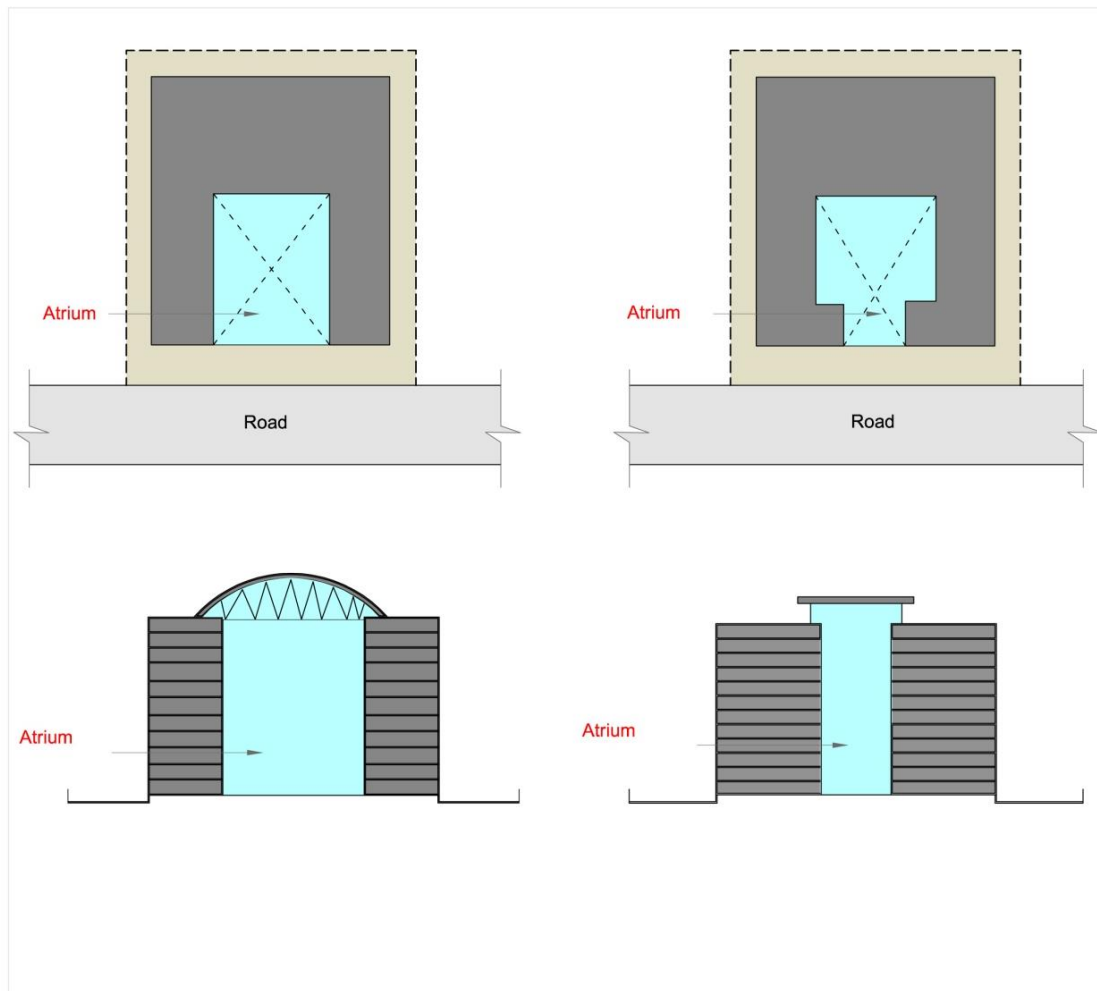

Figure No. 2.1: Atrium Within a Building

- 2.14 *Authorized Officer*: means any person appointed by the Competent Authority for the any specific purpose under these rules. There can be different authorised officers for different purposes.
- 2.15 *Authority*: Authority means either Planning and Development Authority or the Municipal Council, or any other authority specifically notified by the UT administration under these Rules, having jurisdiction over area in question.

- 2.16 *Banquet Hall*: means a room or an enclosed space or building for the purpose of hosting any social events or ceremonies like marriage, reception, party etc. accompanied with food and beverages.
- 2.17 *Basement*: means the lower storey of a building below the ground level.
- 2.18 *Build to Line*: means a means a line extending along the roadside margin and marks the location from which the vertical plane of the front building elevation must be erected; the build-to line is intended to create an even building façade line along a street. A certain percentage of the length of the roadside margin may be specified to which the building elevation must abut (*Refer Figure No. 2.2*).

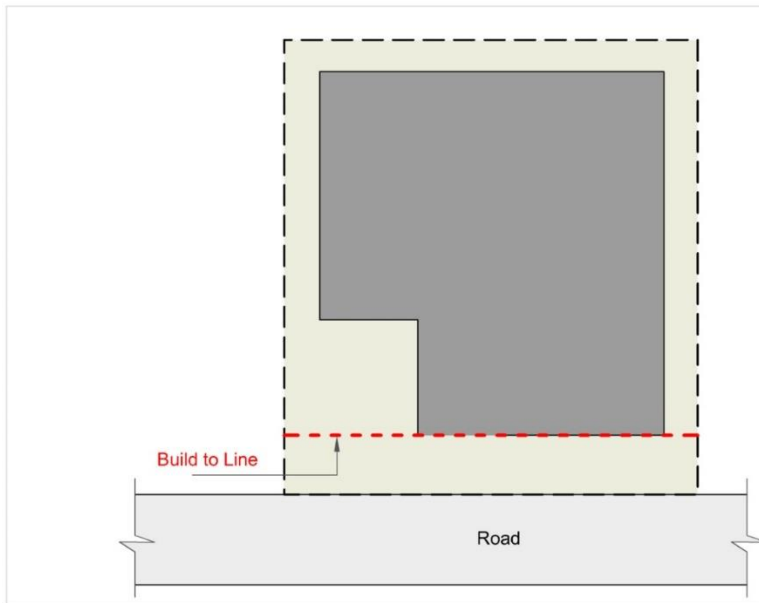

Figure No. 2.2: Built to Line for a Building

- 2.19 *Building*: means a structure constructed with any materials whatsoever for any purpose, whether used for human habitation or not, and includes:
- i) Foundation, plinth, walls, floors, roofs, chimneys, plumbing and building services, fixed platforms etc.
 - ii) Verandahs, balconies, cornices, projections etc.
 - iii) Parts of a building or anything affixed thereto;
 - iv) Any wall enclosing or intended to enclose any land or space, sign, and outdoor display structures; etc.,
 - v) Tanks constructed or fixed for storage of chemicals or chemicals in liquid form and for storage of water, effluent, swimming pool, ponds etc.,
 - vi) All types of buildings as defined in (a) to (i) below, except tents, shamianas and tarpaulin shelters erected temporarily for temporary purposes and ceremonial occasions with the permission of Competent Authority, shall be considered to be "buildings".

Types of buildings based on design or typology:

- a) *Detached Building* means a building with walls and roofs independent of any other building and with open space on all sides.
- b) *Semi Detached Building* means a building detached on three sides with open space as specified in these Rules.
- c) *Tenement* means a residential dwelling unit constructed in a detached or semi-detached manner. Each dwelling unit in a tenement building is designed and constructed for separate entry with independent sanitary provisions.
- d) *Multi-Storeyed Building – High Rise* means a building with above 4 storeys, and/or a building exceeding 15 m or more in height (without stilt) and 17.5 m (including stilt).

- e *Multi-Storeyed Building – Low Rise* means a building 4 storeys and below, and/or a building not exceeding 15 m or more in height (without stilt) and 17.5M (including stilt).
- f *Dwelling 1* means a detached building used for residential purpose.
- g *Dwelling 2* means semi-detached building used for residential purpose.
- h *Dwelling 3* means multi storey building used for habitation of multiple families and/or individuals such as apartments, flats, hostels, lodging and boarding or cottage industry or pre-school purpose.
- i *Special Building* means a building that houses large gatherings at a time such as theatres for drama, cinema, motion picture; drive-in-theatre; assembly hall; auditorium; town hall; lecture hall; exhibition hall; museum; stadium; community hall; marriage hall, banquet hall etc.
- j *Multi Level Car Parking*: means a building primarily to be used for parking of cars, scooters, or any other type of light motorized vehicle. It may include two or more basements.

Types of buildings based on safety / maintenance:

- k *Hazardous building* means a building or part thereof used for:
 - 1 Storage, handling, manufacture, or processing of radio-active substances or of highly combustible explosive materials or products which are liable to burn with extreme rapidity and/or producing poisonous fumes.
 - 2 Storage, handling, manufacture, or processing of, which involves highly corrosive, toxic obnoxious alkalis, acids, or other liquids, gases or chemicals producing flame, fumes and explosive mixtures or which result in division of matter into fine particles and capable of spontaneous ignition.
 - 3 Buildings or industries declared as hazardous by any act, rule, regulation or order of any authority.
- l *Unsafe Building* means a building which, is structurally unsafe; is insanitary; is not provided with adequate means of egress; constitutes a fire hazard; is dangerous to human life in relation to its existing uses; constitutes a hazard to safety or health or public welfare by reasons of inadequate maintenance, dilapidation, or abandonment.
- 2.20 *Building Unit / Plot*: means a land or plot or part of a land / plot or combination of more than one land / plot enclosed by definite boundaries as approved by the Competent Authority. However, where an alignment has been fixed on any road by any Competent Authority, the Building Unit shall mean and refer to the land excluding the portion falling in alignment.
- 2.21 *Building Unit / Plot Depth*: means the mean horizontal distance between the front and rear plot boundaries.
- 2.22 *Built up Area*: means the area covered by a building on all floors including all cantilevered portions and walls & columns, excepting areas that are excluded specifically under these Rules (Refer Figure No. 2.3).

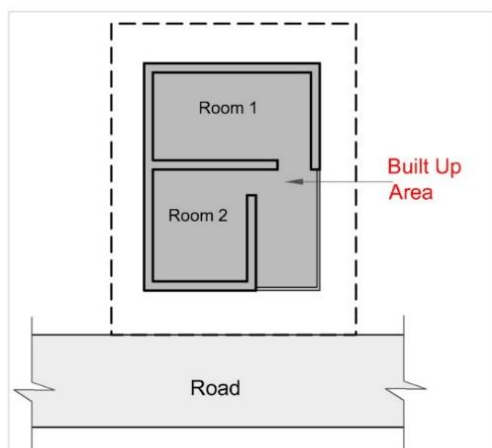

Built Up Area = Carpet Area + Walls

Figure No. 2.3: Built up Area, Building

2.23 *Built up Area, Carpet:* means the covered area of usable rooms of dwelling unit / building, excluding area covered by walls (Refer Figure No. 2.4).

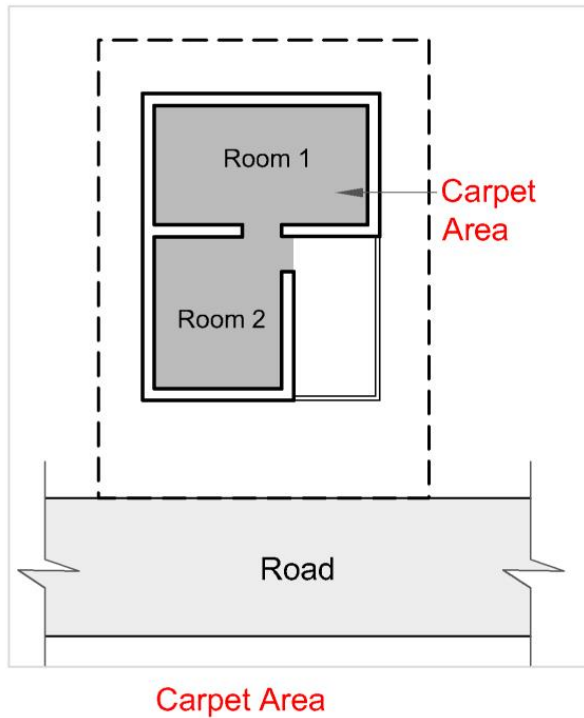

Figure No. 2.4: Carpet Area

2.24 *Built up Area, Dwelling Unit:* means the areas covered by a dwelling unit within a building including all cantilevered portions and walls & columns, excepting the areas excluded specifically under these rules (Refer Figure No. 2.5).

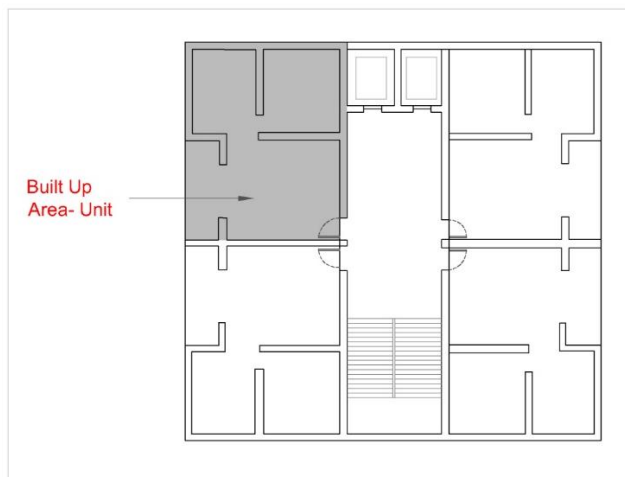

Fig No. 2.5: Built Up Area, Dwelling Unit

2.25 *Cabin:* means a non-residential enclosure.

2.26 *Canopy:* means cantilevered projection at lintel or slab level provided that it shall not extend beyond the building unit boundary and there shall be no structure on it and the top shall remain open to sky.

2.27 *Chairman PDA:* means the chairman of a Planning and Development Authority

2.28 *Chawl:* A building divided into many separate tenements suitable for living, each consisting of a single room, or two, but not more than two rooms and with common sanitary arrangements.

- 2.29 *Chhajja / Weather Shed*: means a structural overhang provided over opening on external walls for protection from weather.
- 2.30 *Chief Officer*: means an Officer appointed by the Government under the Municipal Regulation for any Municipal Council to whom the duties and functions of the Chief Officer may be assigned within the territory.
- 2.31 *Chimney*: means a construction by means of which a flue is formed for the purpose of carrying products of combustion to open air and includes a chimney stack and a flue pipe.
- 2.32 *Chowk*: means a fully or partially enclosed space permanently open to sky within a building at any level.
- 2.33 *Cold Storage*: means a structure or room for the storage of edible or non-edible merchandise or commodities, which usually require special low temperatures and condition for storing or preservation, before their export or distribution for sale.
- 2.34 *Collector*: means the Collector appointed by the Government for the District.
- 2.35 *Competent Authority*: means any person or persons or Authority or Authorities authorized by the Government by any act, rules, byelaws, or order, to exercise any given function. Different persons or Authorities may be authorized to perform different functions.
- 2.36 *Common Plot*: means a common open space exclusive of approaches at ground level or at higher levels not exceeding 15.0 m from the ground level of the building unit.
- 2.37 *Community Hall*: means a building and accompanying ground such as wadis used for social, civic, or recreational purposes, serving the area in which it is located and open to the general public. It is also a place where members of community tend to gather for group activities, social support, public information, and other purposes.
- 2.38 *Construction*: means erection of a structure whether permanent or temporary or a building, including any addition or extension thereto either vertically or horizontally, but does not include, any reconstruction, repair and renovation of an existing structure or building, or, construction, maintenance and cleansing of drains and drainage works and of public latrines, urinals and similar conveniences, or, the construction and maintenance of works meant for providing supply of water for public, or, the construction or maintenance, extension, management for supply and distribution of electricity to the public; or provision for similar facilities for publicity, all of which may also be in the ROW of roads/streets after obtaining due permissions of any authority.
- 2.39 *Contiguous Holding*: means a continuous parcel of land in one ownership irrespective of separate survey numbers or revenue maps of the holding (*Refer Figure No. 2.6*).

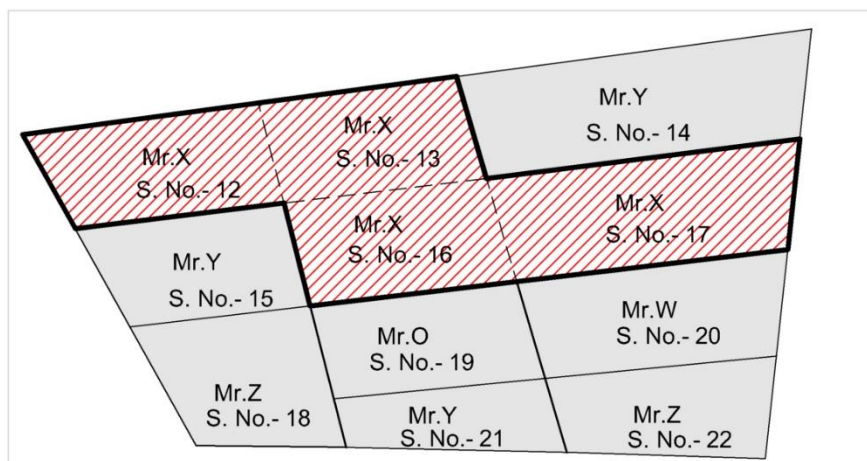

Fig No. 2.6: Contiguous Holding

- 2.40 *Conversion*: The change from one occupancy to other occupancy or any change in building structure or part thereof resulting in a change of space and use requiring additional occupancy certificate.

- 2.41 *Cornice*: means the decorated projection at the top of a wall provided to protect the wall face or to ornament and finish the eaves. The term is used as well for any projecting element that crowns an architectural feature, such as a doorway.
- 2.42 *Corridor*: means a common passage or circulation space including a common entrance lobby (Refer Figure No. 2.7).

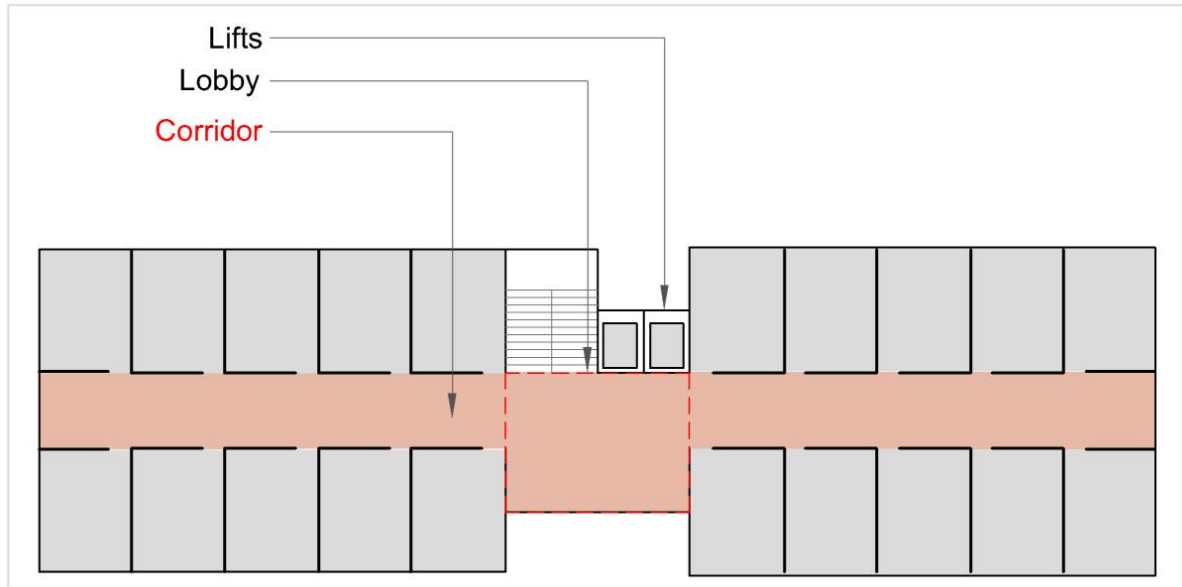

Figure No. 2.7: Corridor

- 2.43 *Council or Municipal Council*: means a Municipal Council constituted or deemed to be constituted under Dadra and Nagar Haveli and Daman and Diu Municipal Council Regulation 2004.
- 2.44 *Courtyard*: includes a chowk and also includes all spaces permanently open to the sky within a building.
- 2.45 *Density*: The residential density expressed in terms of the number of dwelling units per hectare.
- 2.46 *Developer*: means a person who has, by any law or contract, control over or would have had control over: 1) the appointment of registered professionals under these rules; 2) the design of the building; 3) the process of construction of the building and development, and; 4) financing of the construction and development. This control should be sufficient to ensure compliance of the various provisions related to development under these Rules.
- 2.47 *Development Permission*: means a permission granted by the Competent Authority to carry out any construction, reconstruction, erection, or re-erection permitted under these Rules.
- 2.48 *Dharamshala*: means a building devoted to religious or charitable purposes offering lodging and / or dining facilities for interested individuals or group of people at a nominal charge, or in some cases free of charge.
- 2.49 *Domestic Wastewater*: means either wastewater that is typically discharged from premises that are used solely for residential activities or wastewater of the same character discharged from any non-industrial and non- medical buildings.
- 2.50 *Drain / Drainage System*: means a system or a line of pipes or box or any other structure, with their fittings and accessories as manholes, inspection chambers, traps, gullies, floor traps used for drainage of buildings or yards appurtenant to the buildings within the same curtilage. A drain includes an enclosed or open channel for conveying surface water or a system for the removal of any liquid.
- 2.51 *Dwelling Unit*: means a shelter consisting of residential accommodation for one family and shall include a minimum of one room (with a carpet area of 9 sq m and one side 2.4 m), one kitchen, bathroom and WC.

- 2.52 *Enclosed staircase*: means a staircase separated by walls and doors from the rest of the building.
- 2.53 *Escalator*: means a power driven, inclined, continuous stairway used for raising or lowering passengers.
- 2.54 *Escape Route*: means a route by which a person may reach an unenclosed space at ground level in the open air and in relation to:
- i) any point on a storey of a building, means a route from that point
 - ii) any room, means a route from the doorway of that room
 - iii) any storey of a building, means a route from the exit from the storey
 - iv) any flat, means a route from the main entrance door of the flat
- 2.55 *External Wall*: means an outer wall of a building not being a party wall even though adjoining a wall of another building and also means a wall abutting on an interior open space of any building.
- 2.56 *Existing Development / Building / Use*: means development, building, structure or its use as sanctioned, approved, regularized, authorized by the Competent Authority, existing prior to the date of notification of these rules.
- 2.57 *Farmhouse*: means a plot of land including permissible construction in the area designated as agricultural zone by the Competent Authority with a minimum land area of 4400 sq m.
- 2.58 *Floor*: means the lower surface in a storey on which one normally walks in a building and does not include a mezzanine floor. The floor above top most basement, closest to the ground, shall be ground floor. The floor above it with minimum permissible height shall be termed as first floor or floor 1, with the next higher floor shall be termed as second floor or floor 2, and so on upwards.
- 2.59 *Floor Area*: means the net enclosed area of a floor in the building including walls, circulation spaces like lobby or corridors, service areas and semi-open spaces such as verandah or balcony.
- 2.60 *Floor Space Index (FSI) or Floor Area Ratio (FAR)*: means the quotient of the ratio of the combined gross built-up area of all floors, to the total area of the building-unit (total plot area including common plot)

$$\text{Floor Space Index} = \frac{\text{Total Built up area of all floors.}}{\text{Area of the Building Unit / Plot}}$$

- 1 Base FSI – means the base FSI permitted in a Zone by the Competent Authority as a matter of right.
 - 2 Chargeable FSI – means the FSI available by payment.
 - 3 TDR FSI – means the FSI available by purchasing TDR
 - 4 Maximum Permissible FSI – means the maximum permissible FSI which includes Base FSI, Chargeable FSI and TDR FSI.
 - 5 Utilized Chargeable FSI – means the amount of FSI used that is paid for and purchased by the applicant.
 - 6 Total Utilized FSI – means the total Utilized FSI.
- 2.61 *Footing*: means a foundation unit constructed in brick work or stone masonry or concrete under the base of a wall or column for the purpose of distributing the load over a large area.
- 2.62 *Foundation*: means that part of the structure which is in direct contact with and transmitting load of the building to the ground.
- 2.63 *Front*: means the main frontage of a building unit on the roadside. For building units abutting two or more roads, the side along the wider road shall be considered as the front. In case of roads of equal width, the front shall be chosen by the owner / developer (*Refer Figure No. 2.8*).

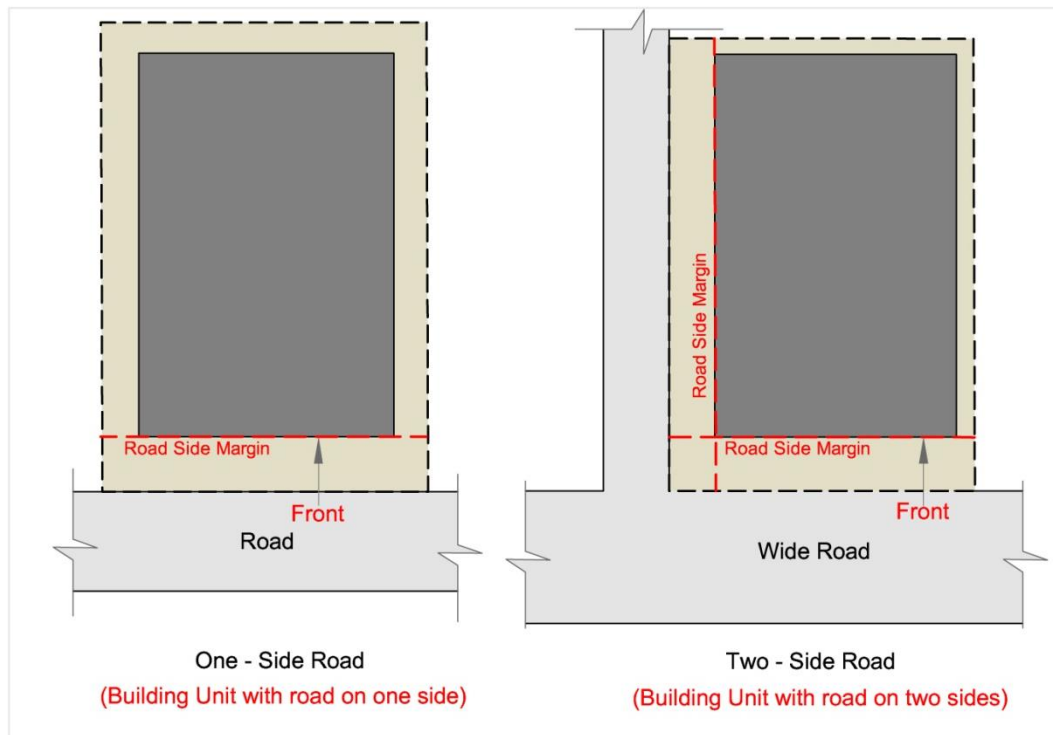

Figure No. 2.8: Front

- 2.64 *Gaothan or Gamtal*: means all lands included within the site of a village at the commencement of the Dadra and Nagar Haveli, Daman & Diu Land Revenue Regulation in accordance with any survey, custom or usage or which may be declared as included within the site of village in accordance with the provisions of the said Regulation.
- 2.65 *Garage-Private*: means a building or a portion thereof, designed and used for the parking of vehicles. It can be within a building or within a portion of a building unit but does not include an unenclosed or uncovered parking space such as open parking area.
- 2.66 *Garage-Public*: means a building or a portion thereof, designed other than as a private garage, and operated for gain. It can be used for repairing, servicing, hiring, selling, storing, parking of vehicles.
- 2.67 *Government*: means The Administrator of Dadra and Nagar Haveli, Daman and Diu appointed by the President of India under Article 239 of Constitution of India.
- 2.68 *Ground Coverage*: means the ground area covered by a building including cantilevered portion on any floor, excluding margins, common plot, cut-out (open-to-sky) if any.
- 2.69 *Ground Level*: means the level of the crown of the existing adjacent constructed road or the existing ground level or the high flood level, whichever is higher as may be decided by Competent Authority.
- 2.70 *Habitable Room*: means a room occupied or designed for occupancy for human habitation and uses incidental thereto, including a kitchen if used as a living room, but excluding a bathroom, water closet compartment, laundry, serving and storing, pantry, corridor, cellar, attic, storeroom, pooja room and spaces not frequently used.
- 2.71 *Hazardous Material*: means any of the following materials:
- 1 Radioactive substance.
 - 2 Inflammable, combustible or explosive materials that may produce poisonous fumes or explosions on storage, handling, processing or manufacturing.
 - 3 Corrosive, toxic, obnoxious alkalis or acids, chemicals which may produce irritant, corrosive or poisonous gases on explosion or spontaneous combustion.
 - 4 Material declared as hazardous by any act, rule, regulation or order of any Competent Authority
- 2.72 *Height of a Room*: means the vertical distance measured from the finished floor surface to the finished ceiling/ slab surface. The height of a room with a pitched roof means the average

height between the finished floor surface and the bottom of the eaves and the bottom of the ridge (Refer Figure No. 2.9).

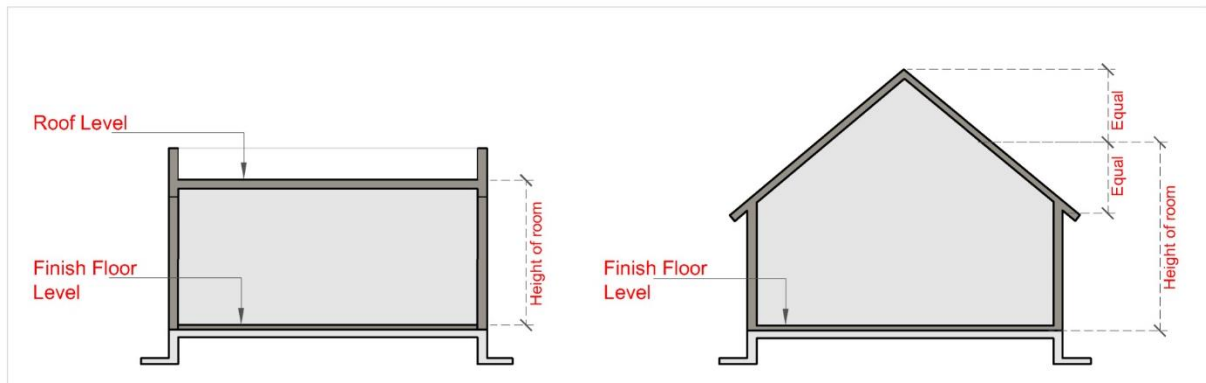

Figure No. 2.9: Height of a Room

2.73 *Height of Building*: means the vertical distance measured from the average ground level and up to the top of the finished level of the topmost floor slab or in case of slopping roofs up to the midpoint of the height of the sloping roof.

The height of the sloping roof shall be taken as an average height of the relevant floor.

Provided that for purpose of other than the fire rules, the following shall be excluded for the computation of building height:

- 1 Lift cabin with machine room above.
- 2 Solar panel provided on roof top.
- 3 Chimney
- 4 Water Tanks
- 5 Mumty
- 6 Stilt Floor whether used for parking or otherwise.

2.74 *Home Occupation*: means such customary home occupation other than the conduct of an eating or a drinking place offering services to the general public, customarily carried out by a member of the family residing on the premises without employing hired labour, and for which there is no display to indicate from the exterior of the building that it is being utilised in whole or in part for any purpose other than a residential or dwelling use and in connection with no article or service is sold or exhibited for sale except that which is produced therein, which shall be non-hazardous and not affecting the safety of the inhabitants of the building and the neighbourhood, and provided that no mechanical equipment is used except that as is customarily used for purely domestic or household purposes and / or employing licensable goods, which are decided by the Competent Authority as Home Occupation from time to time. If motor power is used, the total electricity load should not exceed 0.75 KW. The area for such uses shall not exceed 25% of the total floor area of the dwelling; further, there shall be no public display of goods. Dwelling units used for home occupation shall not be considered as mercantile building or commercial operation.

2.75 *Illuminated Exit Signs*: A device for indicating the means of escape during normal circumstances and power failure.

2.76 *Land*: means the land on which construction is proposed by the owner / developer and shall include benefits to arise out of land, things attached to the earth or permanently fastened to anything attached to the earth and rights created by legislative enactment over any street. For avoidance of doubts, it is hereby clarified that land can include any contiguous holding.

2.77 *Lift / Elevators*: means a mechanically guided car platform or transport for persons and materials between two or more levels in a vertical or substantially vertical direction.

2.78 *Lobby*: means a hall at the entrance of a building or corridor / hall connected with a larger room or series of rooms and used as a passageway or waiting room.

2.79 *Loft*: means an intermediate non habitable slab between two floors which is constructed and used for storage purpose in accordance with Rule 13.1.9.

- 2.80 *Margin*: means the space adjacent to boundary of building unit, buildings, or common plot that should be kept fully open to sky. No built up shall be permitted in marginal space except as specified in these Rules (Refer Figure No. 2.10).

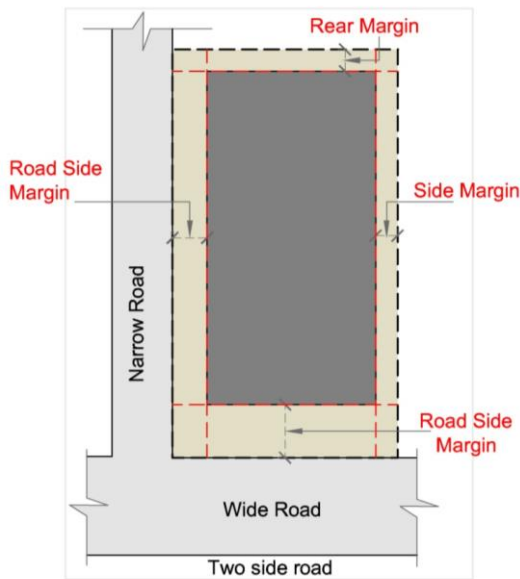

Figure No. 2.10: Margins

- 1 Roadside Margin: means the space provided from the roadside edge of the building unit.
 - 2 Side Margin: means the space provided from the sides of the building unit.
 - 3 Rear Margin: means the space provided from the rear edge of the building unit.
- 2.81 *Member Secretary*: means the member secretary of a Planning and Development Authority appointed by the UT of Dadra and Nagar Haveli, Daman, and Diu.
- 2.82 *Mezzanine Floor*: means an intermediate floor between two floors overhanging or overlooking a floor beneath which is constructed in accordance with these Rules.
- 2.83 *Natural Hazard*: means a potentially damaging natural phenomenon like high intensity earthquake, cyclonic storm, significant flood flow or inundation, landslides, mudflows, avalanches etc.
- 2.84 *Natural Hazard Prone Areas*: means areas with high probability of occurrence of natural hazard.
- 2.85 *Non-Agriculture Permission*: means a permission granted by a Goa, Daman and Diu Land Revenue Code, 1968 under any law for the time being in force permitting a holder/owner of the land to change the land use from agriculture to non-agriculture.
- 2.86 *Non-Ambulatory Disabilities*: means impairments which confine individuals to wheelchairs.
- 2.87 *Non-Potable Water*: means water for non-domestic consumption uses such as car washing, toilet flushing, gardening, construction, landscaping, irrigation etc and which is forbidden for domestic consumption as per drinking water standards set by Government/Appropriate Authority.
- 2.88 *Occupant Load*: means number of persons for which the means of egress of a building or portion thereof is designed.
- 2.89 *Open Space*: means an area forming an integral part of the plot, left permanently open to sky.
- 2.90 *Owner*: means a person who receives rent for the use of the land or building or would be entitled to do so if it were let, and includes: -
- 1 An authorised agent or trustee who receives such rent on behalf of the owner.
 - 2 A receiver, executor or administrator, or a manager appointed by any court of competent jurisdiction to have the charge of or to exercise the rights of the owner.
 - 3 An agent or trustee who receives the rent or is entrusted with or is concerned with any building devoted to religious or -charitable purposes; and
 - 4 A mortgage in possession.

- 2.91 *Parapet*: means a low wall or railing built along the edge of roof of a floor such as terrace, balcony, mezzanine, or staircase.
- 2.92 *Parking Space*: means an enclosed, semi-covered or open area including driveway and access aisles required to park vehicles, as per Rules related to parking. Parking spaces shall be served by a driveway connecting them with a street or alley and permitting ingress or egress of vehicles (Refer Figure No. 2.11).

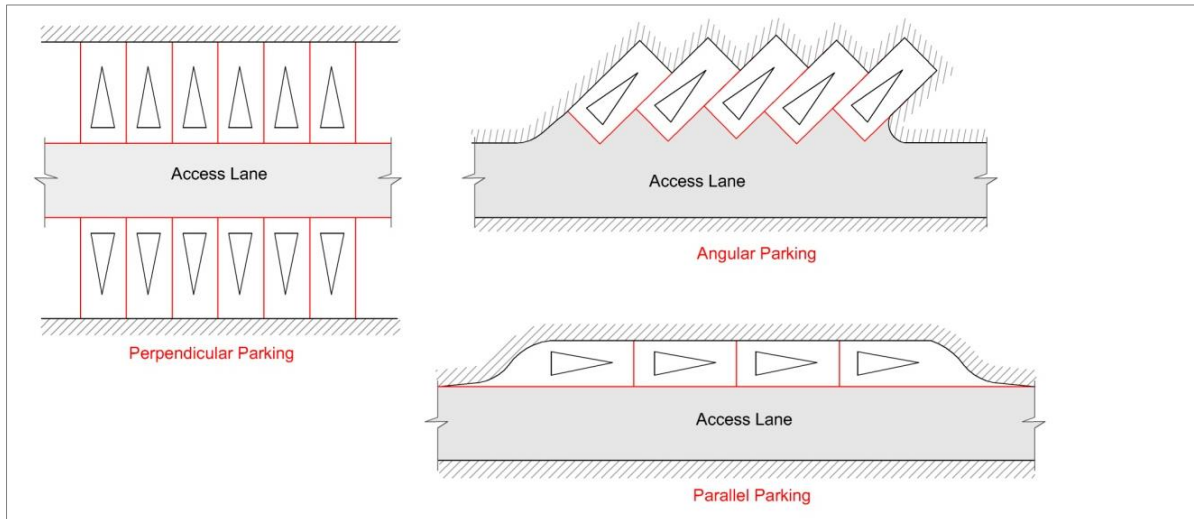
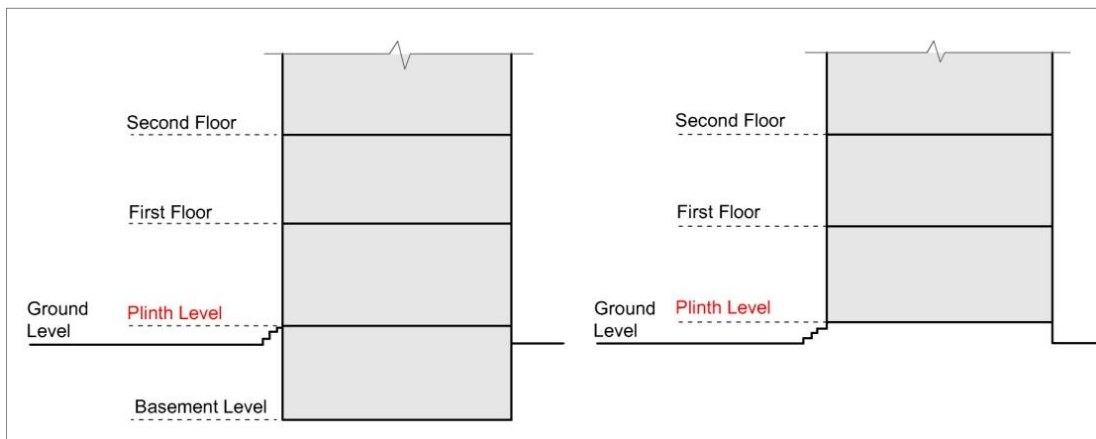

Figure No. 2.11: Parking Space

- 1 *Covered Parking Space*: means an enclosed, semi-covered area including driveway and access aisles required to park vehicles, as per Rules related to parking but does not include the garage-private or public.
 - 2 *Open Parking Space*: means a semi-covered or open area including driveway and access aisles required to park vehicles, as per Rules related to parking. Parking spaces shall be served by a driveway connecting them with a street or alley and permitting ingress or egress of vehicles.
- 2.93 *Partition*: means an interior non load bearing divider one storey or part storey in height.
- 2.94 *Persons on Record*: Architect, Civil Engineer, Structural Designer, Clerk of Works, Qualified Agency for Fire and registered with the Competent Authority and undertaking the responsibility for the particular work as prescribed by the Competent Authority.
- 2.95 *Plinth*: means the solid or hollow volume below the floor which is immediately above the ground level. Also, Hollow Plinth means the space provided below the floor which is on stilts immediately above the ground level for the purpose of parking and other permissible uses (Refer Figure No. 2.12).



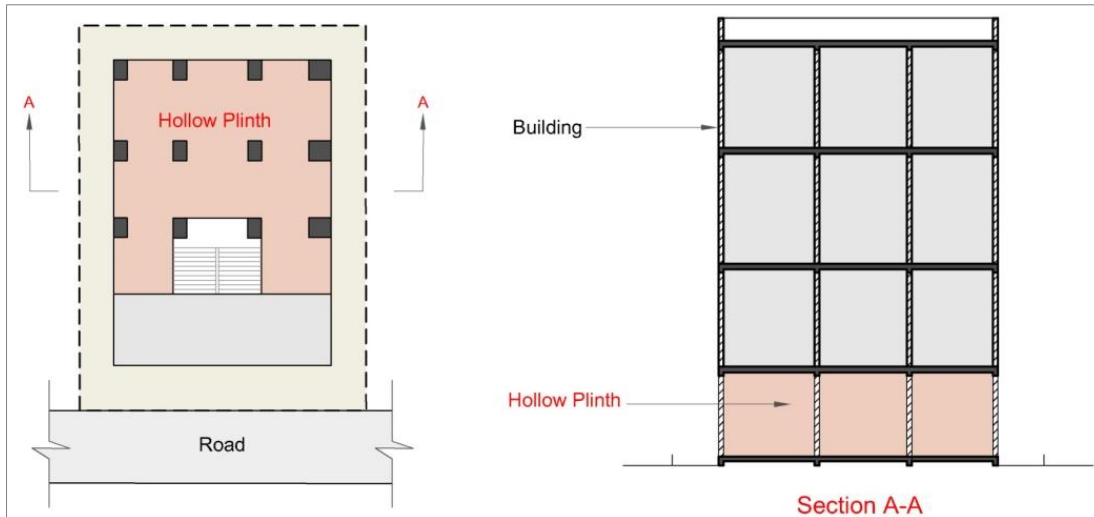

Figure No. 2.12: Plinth

- 2.96 *Pergola*: means an architectural feature or element of any material, which is used for aesthetic and elevation purpose and open on all sides including top side. In any case it shall not be integral part of any habitable space.
- 2.97 *Porch*: Means a covered surface supported on pillars or otherwise for the purpose of a pedestrian or vehicular approach to a building exclusive of marginal space (Refer Figure No. 2.13).

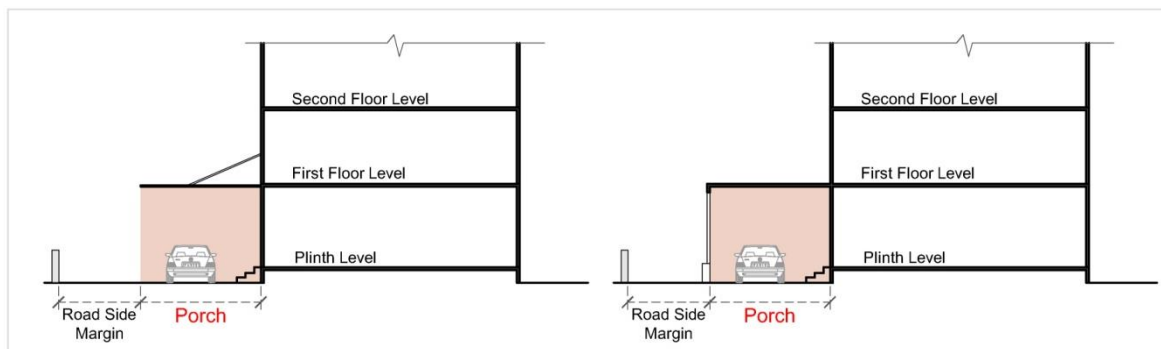

Figure No. 2.13: Porch

2.98 *Premises*: means either:

- 1 A property which is held under a separate record title or for which a separate title record or certificate may be issued and in respect to which a building plan have been or may be issued or
- 2 A building which is in possession as an individual unit by a cross-lease, unit title or company lease and for which a certificate of title is available or
- 3 Land held in public ownership, for a particular purpose or
- 4 Separately assessed to local authority taxes, individual unit within building.

2.99 *Prohibited Industrial Waste*: means an industrial waste having physical and chemical characteristics in excess as decided by Appropriate Authority for the time being in force.

2.100 *Pre-school*: means a school for young children, also known as kindergarten or nursery.

2.101 *Public Purpose*: The expression of “Public Purpose” includes:

- 1 Provision of land to any end for common use of public in a Outline Development Plan, Town Planning Scheme as enumerated in the Act;
- 2 Provision of village sites, or the extension, planned development or improvement of existing village sites.
- 3 Provision of land for town or rural planning.

- 4 Provision of land for planned development of land from public funds in pursuance of any scheme or policy of Government and subsequent disposal thereof in whole or in part by lease, assignment, or outright sale with the object of securing further development as planned.
 - 5 Provision of land for a corporation owned or controlled by the Government.
 - 6 Provision of land for residential purposes to the poor or landless or to persons residing in areas affected by natural calamities, or to persons displaced or affected due to implementation of any scheme undertaken by Government, any local Authority or a corporation owned or controlled by the Government.
 - 7 Provision of land for carrying out any educational, infrastructure housing, health or slum clearance scheme sponsored by Government, local authority or any other authority or body established by or under any law for the time being in force.
 - 8 Provision of land for any other scheme of development sponsored by Government or with the prior approval of appropriate Government, by a local Authority.
 - 9 The provision of any premises or building for locating a public office, but NOT acquisition of land for companies.
 - 10 The provision of land for a facility for physically challenged person.
- 2.102 *Renovation and Repair*: means any work to an existing building or structure, which improves its condition without structural alterations or changes to the building or structure.
- 2.103 *Rear*: means that portion of a building unit which is on the opposite side of the front.
- 2.104 *Registered Architect / Structural Engineer/ Civil Engineer*: A person on record having prescribed qualifications registered by the Competent Authority.
- 2.105 *Retrofitting*: means upgrading the strength of an unsafe building by using suitable engineering techniques.
- 2.106 *Road / Street*: means any road, footway, pathway, passageway, square, court, alley, or passage, accessible whether permanently or temporarily to the public, whether a thoroughfare or not; and shall include every vacant space, notwithstanding that it may be private property and partly or wholly obstructed by any gate, post, chain or other barrier, if houses, shops or other buildings abut thereon and if it is used by any person as a means of access to or from any public place or thoroughfare, whether such person be occupier of such buildings or not, but shall not include any part of such space which the occupier of any such building has a right at all hours to prevent all other persons from using as aforesaid.
- 2.107 *Road / Street – Public*: means any street.
- 1 Over which the public have a right of way and or which is declared a public street in the Outline Development Plan or any other notification by the Government.
 - 2 heretofore levelled, paved, metalled, channelled, sewerred or repaired out of municipal or other public funds; .
- 2.108 *Road / Street Level or Grade*: means the officially established elevation or grade of the centre line of the street upon which a plot fronts, and if there is no officially established grade, the existing grade of the street at its midpoint.
- 2.109 *Road / Street line*: means the line defining the side limits of a road / street or the side limits of the proposed ROW of the road as notified by the Government and shall include regular line of street as defined by any Authority.
- 2.110 *Road width or Width of road / street*: means the whole extent of space within the boundaries of a road when applied to a new road/street, as laid down in the city survey, Outline Development Plan, Town Planning Scheme or prescribed road lines by any act or law, and measured at right angles to the course or intended course of direction of such road / street.
- 2.111 *Row houses*: means group of residential buildings, on adjacent plots with or without common walls, often of similar or identical design, situated side by side and joined by common walls and having only front and rear open spaces.
- 2.112 *Service Apartment*: means a type of furnished apartment including kitchen or cooking facility and amenities for daily use, available for short term or long-term stays.
- 2.113 *Service Road*: means a road / lane provided at the front, rear, or side of a plot for service purpose.

2.114 *Setback Line*: means the line from an adjoining a street that indicates an extension of a street or a future street that may lawfully extend, in case of a non-Outline Development Plan Road or Town Planning Scheme Road. Roadside margin shall be considered from this imaginary plot boundary thus established. This additional land to be left is defined as setback. The setback line may change from time – to – time as decided by the Competent Authority (*Refer Figure No. 2.15*).

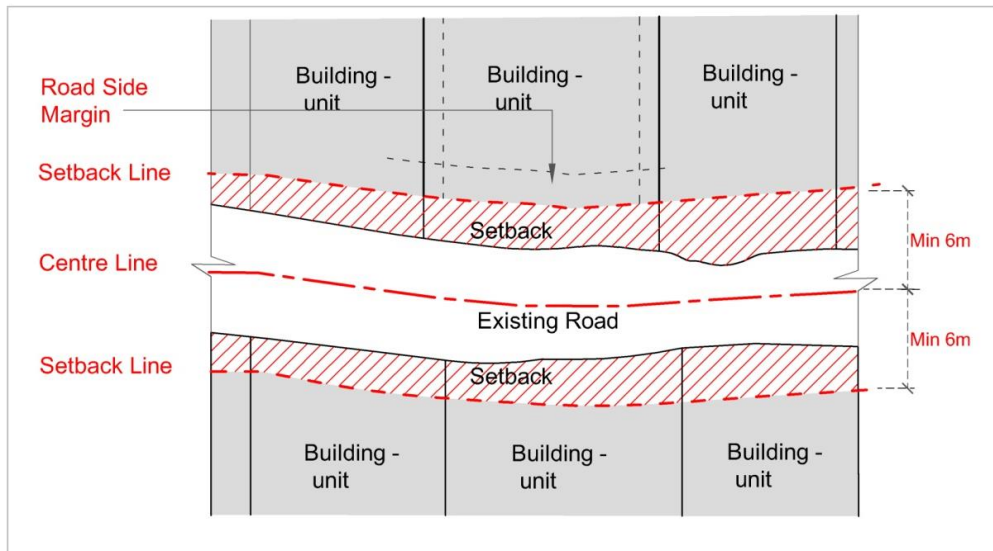

Figure No. 2.15: Setback Line from an Existing Street Not in the ODP/TPS

2.115 *Solid Waste*: means and includes solid or semi-solid domestic waste, sanitary waste, commercial waste, institutional waste, catering and market waste and other non-residential wastes, street sweepings, silt removed or collected from the surface drains, horticulture waste, agriculture, and dairy waste, treated bio-medical waste excluding industrial waste, bio-medical waste and e-waste, battery waste, radio-active waste generated in the area.

2.116 *SPARSH 2.0 Housing*: means various types of housing developments as delineated in SPARSH 2.0 Notification No- LE/LI/DMN/260/SPARSH/2018/11 as amended from time to time.

- 1 *Affordable Housing in Partnership Housing*: means a housing project that has been approved by the appropriate Government as Affordable Housing in Partnership project and is entitled for any subsidies, if available, from the Appropriate Government.
- 2 *Low-Cost Housing complexes*: means either such housing in which at least 80% of dwelling units are residential flats having a carpet area of not exceeding 46.5 sq m (500 sq ft) and not less than 30 sq m (325 sq ft) which are intended to be sold to or hired by economically weaker sections of the society, or are labour dormitories with a carpet area of not less than 325 sq ft containing individual toilets which are intended to be hired to labourers, industrial workers etc.
- 3 *Housing under SPARSH*: means such housing which fulfils criterion mentioned in the SPARSH scheme as notified or amended by the Administration of the Union Territory of Dadra and Nagar Haveli or Daman or Diu or any of its predecessors or successors from time to time.
- 4 *Housing under ARHC*: means such housing which fulfils the criterion mentioned in the Affordable Rental Housing Complex scheme as notified or amended by the Union of India or Ministry of Housing and Urban Development from time to time.

2.117 *Stair Cabin / Stair Cover / Mumty*: means a structure with a covering roof over a staircase and its landing built to enclose only the stairs for the purpose of providing protection from the weather, and not to be used for human habitation (*Refer Figure No. 2.16*).

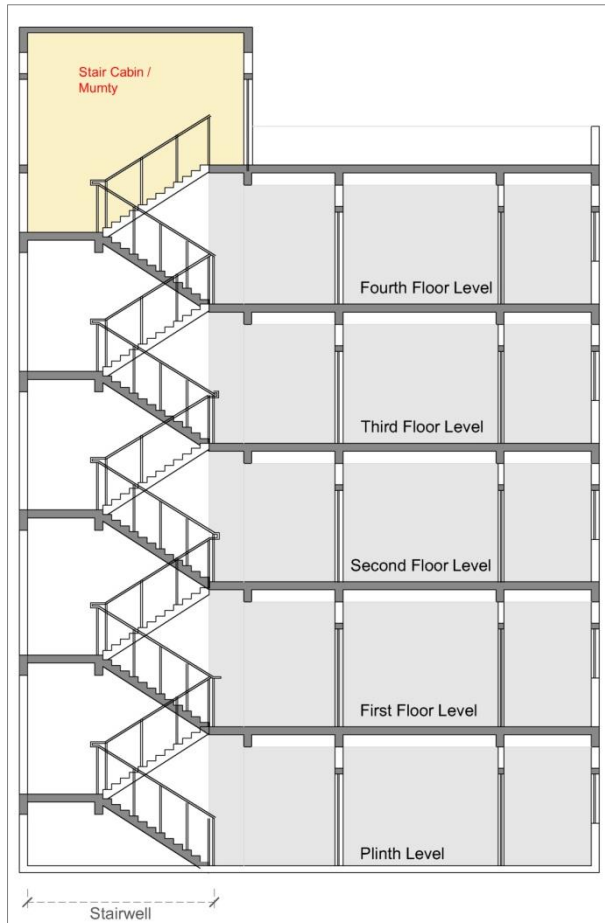

Figure No. 2.16: Stair Cabin / Mumty

- 2.118 *Staircase*: means a flight or series of flights of steps with the supporting framework, casing, and balusters, constructed to connect different floors or levels in a building.
- 2.119 *Stairwell*: means a vertical shaft around which a staircase has been built.
- 2.120 *Storey*: means the portion of a building included between the surface of any floor and the surface of the floor above it, or if there is no floor above it, then the space between any floor and the ceiling next above it.
- 2.121 *Temporary Structure*: means structures such as tents, shamianas etc where roof or walls are not made of RCC, brick, masonry etc, and are erected for temporary or ceremonial purposes.
- 2.122 *To Erect*: in relation to a building means:
- 1 To erect a new building on any site whether previously built upon or not.
 - 2 To re-erect any building of which portions or entire building above the plinth level have been pulled down, burnt, or destroyed.
- 2.123 *Transferable Development Rights (TDR)*: means a mechanism by which the Floor Space assigned to one building unit / plot can be traded for use on another building unit / plot. The Competent Authority shall identify the building unit / plots eligible for selling the TDR, receiving the TDR and the amount of floor space available for trading.
- 2.124 *Unauthorised Construction*: means any construction that is not approved by the Authority.
- 2.125 *Use / Occupancy*: Occupancy or Use is either existing occupancy / use or authorised occupancy / use. Existing Occupancy/use means the principal occupancy of a building for which the building or a part of it is used or intended to be used, including contingent subsidiary occupancies. Authorised Occupancy / use means the principal occupancy of an approved building for which the building or a part of it is permitted to be used, including contingent subsidiary occupancies. Mixed / multiple occupancy / use buildings being those in which more than one occupancy / use are present in different portions of the building / intermingled.

- 1 *Use – Agricultural:* means use of land for horticulture, farming, raising of crops, fruits, vegetables, grass, fodder, trees or any other kind of cultivation, breeding and keeping of live-stock, including horses, donkeys, mules, pigs, fish, poultry and bees, gaushalas and the use of land for any purpose which is ancillary to its cultivation or to any other agricultural purpose but does not include the use of land as a garden which is an appendage to a building and then expression “agriculture” shall be constructed accordingly.
- 2 *Use - Farm buildings:* means a structure erected on land assessed or held for the purpose of agriculture for all or any of the following purposes connected with such land or any other and belonging to or cultivated by the holder thereof, namely:
 - For the storage of agricultural implements, manure, or fodder.
 - For the storage of agricultural produce.
 - or sheltering cattle.
 - For the residence of members of the family, servants, or tenants of the holder, or
 - For any other purpose which is an integral part of his cultivating arrangement.
- 3 *Use – Assembly:* means a building or place or part thereof that is used for congregation of people for the cultural, amusement, recreational, social, religious, patriotic, civil, travel and similar such purposes and this includes building/s of auditorium, city hall, town hall, theatre hall, cinema theatre, exhibition hall, museums, party plot, community hall, banquet hall, dance hall, multiplex, shopping mall, stadium, skating rinks, gymnasias, restaurants, eating or boarding houses, places of worship, dance halls, clubs, gymkhanas, road, railways, air, sea or other public transportation stations, and recreation areas.
- 4 *Use – Business / Offices:* means any building or place or part thereof used for transaction of business and / or keeping of books and records such as offices, banks, professional establishments, etc. Use for office includes work for the purpose of administration, clerical work, handling money, telephone, telegraph, publication, and computer operation.
- 5 *Use – Commercial / Mercantile:* means any building or place or part thereof used for mercantile and business use – shops, stores or markets for display and sale of wholesale / retail goods; offices and services.
- 6 *Use – Educational:* means a building or place or part thereof that is exclusively used for a preschool, school, college, polytechnic, recognised by the appropriate board or university, or any other Competent Authority involving assembly for instruction, education or recreation, incidental to educational use. Such use includes other incidental uses such as a library or a research institution, quarters for essential staff to reside in the premises, and a building used as a hostel for an educational institution whether situated in its campus or not.
- 7 *Use – Health:* means a building or place or part thereof used for healthcare facility such as medical or diagnostic or research centres, hospitals, nursing homes and care centres for elderly, destitute, orphans, abandoned women, children, and infants.
- 8 *Use – Hospitality:* means a commercial establishment in building or place or part thereof providing lodging and usually meals, entertainment, and various personal services to public on a short-term basis except homestays registered under the law for the time being in force.
- 9 *Use – Industrial:* means a building or space or part thereof wherein products or material is fabricated, assembled, or processed, such as assembly plants, laboratories, power plants, refineries, gas plants, mills, dairies, and factories.
- 10 *Use – Mercantile:* means a building or place or part thereof used for display and sale of wholesale or retail goods / merchandise, including ancillary uses such as office, storage and service facilities in the same premise. This use includes shops, stores, markets, shopping centre, shopping mall, wholesale market.
- 11 *Use – Public Utility:* means a building or premise or part thereof constructed for infrastructure and safety facilities such as electrical sub-station, fire station, bus-station, bus terminals, fuelling station, multi-level parking, water purification facility, pumping station, postal networks, and communication networks etc.

- 12 *Use – Public Offices*: means office facilities in a building or premise or part thereof, constructed/operated by Government (Central / State), Local Bodies and Public Sector Undertakings etc, used for or opted to be used as office / hospital / college / school / hall / exhibition, shops, commercial or for other public purpose activities. This includes buildings such as - Courts, Police Station, Medical facility, Public Library, Civic Centre, Ward, and Zonal Offices for any Authority.
- 13 *Use – Residential*: means a building in which sleeping accommodation is provided for normal residential purposes with sanitation facilities and with or without cooking or dining facilities, and includes one or more family dwellings, hostels, dormitories, apartment units, flats etc.
- 14 *Use – Religious*: means a building or place dedicated to accommodation and service of Religion or other such objects of religious nature. It may have different nomenclature in different religions like temple, mosque, church, gurudwara, synagogue, upashraya, shantniwas, and may have ancillary facilities like ashram, bathing ghat, madrasa and gaushala.
- 15 *Use – Storage*: means a building or place or part there of used primarily for storage or shelter of goods and merchandise. Such use includes warehouse, cold storage, freight depot, transit shed, store house, public garage, hangar, grain elevator and barn.
- 2.126 *Ventilation*: means the supply of outside air into, or the removal of inside air from an enclosed space.
- 2.127 *Warehouse*: means a building or place or part thereof that is used or intended to be used for the storage of goods for stocking, sale, or similar purpose. It usually has loading docks to load and unload goods from trucks and often have cranes and forklifts for moving goods in and around the structure.
- 2.128 *Waterbody*: means a natural existing low-lying ground, forming a natural waterbody or wherein rainwater gets collected and / or plots designated as Talav / Lake / Pond under Outline Development Plan or any legitimate records.
- 2.129 *Water Closet (WC)*: means a privy with an arrangement for flushing the pan with water but does not include a bathroom.
- 2.130 *Water Course*: means a channel that is natural or artificial formed by training or diversion of a natural channel meant for carrying storm and wastewater. A water course that carries storm water discharge of more than 100 hectares area, is termed as major.
- 2.131 *Wayside Shop*: means a shop that is situated at or near the side of a road, path, or highway.
- 2.132 *Wholesale Establishment*: means an establishment wholly or partly engaged in wholesale trade and manufacturing, wholesale outlets, including related storage facilities, warehouses and establishments engaged in truck transport, including truck transport booking warehouses.
- 2.133 *Window*: means an opening, other than a door, to the outside of a building, which provides all or part of the required natural light, ventilation, or both to an interior space.

Note:

Words not defined here will have the same meaning as in the National Building Code or Dadra and Nagar Haveli and Daman and Diu Town & Country Planning Act, 1974 as amended from time to time.

3 Responsibilities of Owner and / or Developer and Persons on Record

3.1 Responsibilities of Owner / Developer

3.1.1 Owner / Developer to Apply for a Development Permission

Application for the Development Permission can be made by Owner or Developer of the plot on which development / building is proposed.

3.1.2 Responsibilities of Owner or Developer

The Owner or Developer shall:

- 1 Be responsible for ensuring that the development / building complies with these Rules.
- 2 Appoint an Architect on Record / Civil Engineer on Record to ensure compliance with all procedural requirements and to certify that the architectural design and specifications of the proposed development / building comply with the Outline Development Plan and these Rules.
- 3 Appoint a Structural Engineer on Record to certify that the structural design and specifications of the proposed development / building comply with these Rules.
- 4 Appoint a Clerk of Works on Record irrespective of type of building / construction in all building units having proposed built-up area more than 1000 sq m for overall constant supervision of construction work on site and such person appointed shall not be allowed to supervise more than ten such sites at a time.
- 5 Appoint a Supervisor on Record irrespective of type of building / construction in all building-units having proposed built-up area more than 250 sq m or irrespective of built-up area in case of Apartments (DW3), Mercantile, mixed use (mercantile + residential) for overall constant supervision of construction work on site and such person appointed shall not be allowed to supervise more than two such site at a time.
- 6 Certify along with the Clerk of Works on Record that the construction of the building has been undertaken as per detailed design and specifications stipulated by the Architect on Record or Civil Engineer on Record and the Structural Engineer on Record.
- 7 Certify along with the Supervisor on Record that the construction of the building has been undertaken as per detailed design and specifications stipulated by the Architect on Record or Engineer on Record and the Structural Engineer on Record and instruction given by Clerk of Works from time to time.
- 8 Obtain a development permission from the Competent Authority prior to commencement of building.
- 9 Submit construction progress reports and certificates as required to the Competent Authority.
- 10 Obtain an Occupancy Certificate prior to making use or occupying the building.
- 11 Not cause or allow any deviations from the sanctioned drawings in course of execution of the project against the instruction of Architect / Civil Engineer / Structural Designer / Clerk of Works and shall bear all responsibility for any irregularity committed in the use and function of the building or its parts for which the approval has been obtained.
- 12 Ensure that no construction is undertaken during the period that the Development Permission has lapsed, is suspended or cancelled.
- 13 Provide adequate safety measures for structural stability and protection against fire hazards likely from installation of services like electrical installation, plumbing, drainage, sanitation, water supply or any other requirements under the rules.
- 14 Ensure that only names of persons on record are displayed on site and no additional names are mentioned.
- 15 Be required to produce the construction documents and its intended use as per sanctioned plan to any prospective buyer.
- 16 Approval of drawings and acceptance of any statement, documents, structural report, structural drawings, progress certificate, or building completion certificate shall not discharge owner, engineer, architect, clerk of work and structural designer, supervisor, developer from their responsibilities imposed under the act or from the development regulations or from any other law for the time being in force.

- 17 Be held responsible if any unauthorized construction, addition, and alteration is done without prior permission of Competent Authority.
- 18 Take adequate measures to ensure that in the course of work, no damage is caused to the work under construction and the adjoining properties, no undue inconvenience is caused to the people in neighbourhood and no nuisance is caused to traffic & neighbouring people by way of noise, dust, smell, vibration etc.

3.2 Registration of Persons on Record (POR)

3.2.1 Registering with the Competent Authority

The Competent Authority shall register architects, civil engineers, structural engineers, developers, clerk of works and supervisor as Architect on Record (AOR), Civil Engineers on Record (CEOR), Structural Engineers on Record (SEOR), Developer on Record (DOR), Clerk of Works on Record (COWOR) and Supervisor on Record (SOR) respectively. Applications for registration of POR should be made in the format prescribed in Schedule No. 1 and Form No. 1. The Competent Authority / Union Territory Administration may use an Online registration system for Persons on Record.

The Qualified Agency on Record for Fire (QAORF) shall be registered by Fire Officer as per The Dadra and Nagar Haveli and Daman & Diu Fire and Emergency Service Regulation, 2021

The registration must be renewed annually.

Provided that any architect, civil engineer, structural engineer, developer, clerk of works and supervisor shall not be required to get himself/ herself registered with more than one Competent Authority. That is to say, one registration with any Competent Authority shall be valid for seeking permission within jurisdiction of any other Competent Authority.

Provided further that any such person on record shall have to register himself compulsorily with the Competent Authority within whose jurisdiction such person ordinarily resides.

3.2.2 Minimum Qualifications and Competence Requirements

Minimum qualifications necessary for registration as Persons on Record shall be as specified in Schedule No. 1.

In case of Qualified Agency on Record for Fire (QAORF), minimum qualification and competence requirement shall be as specified in The Dadra and Nagar Haveli and Daman & Diu Fire and Emergency Service Regulation, 2021.

3.2.3 Registration Fee and Security Deposit

Registration fee and security deposit for registering Persons on Record with the Competent Authority shall be determined by the Competent Authority and are specified in Table No. 3.1.

Table No. 3.1: Registration Fees for Registration as Persons on Record

No.	Person on Record	Registration Fee Payable Annual	Deposit Payable One Time
(1)	(2)	(3)	
1	Architect on Record (AOR)	Rs.4500	Rs.45000 of annual
2	Civil Engineer on Record (CEOR)	Rs.4500	Rs.45000
3	Structural Engineer on Record (SEOR) ¹	SEOR 1	Rs.4500
		SEOR 2	Rs.3500
		SEOR 3	Rs.2500
4	Clerk of Works on Record	COWOR 1	Rs.2000

No.	Person on Record	Registration Fee Payable Annual	Deposit Payable One Time
(1)	(2)	(3)	
	(COWOR) ²		
		COWOR 2	Rs.1500
		COWOR 3	Rs.1000
5	Supervisor of Works on Record (SOR) ³	SOR 1	Rs.1000
		SOR 2	Rs.500
		SOR 3	Rs.250
		SOR 4	Rs.150
6	Developer	Nil	A onetime deposit of Rs. 20 lakhs shall be applicable on all projects where the BUA is more than 700 sq m. The deposit shall be released after one year of obtaining the Occupancy Certificate.

Notes:

- 1 For Grade of SEOR refer Schedule No.1
- 2 For Grade of COWOR refer Schedule No.1
- 3 For Grade of SOR refer Schedule No.1
- 4 Registration of Qualified Agency on Record for Fire (QAORF) shall be by Depart of Fire and Emergency Services, DNH, Daman and Diu

3.2.4 Cancellation of Registration

A registration shall be liable to be cancelled temporarily or permanently by the Competent Authority, if the registered person is found guilty of negligence or default in discharge of responsibilities and duties or of any breach of any of these Rules. In any such case, the said person shall be given a show cause notice and reasonable opportunity of being heard within the period of 7 days of the receipt of the notice, by the Competent Authority for the purpose of these Rules. Appeal against the order of Competent Authority shall lie before Prescribed Authority. Construction works of all projects in which the delinquent person on record is a member may shall be stopped till the person on record is associated with the project.

3.2.5 Penalties

Procedures for ascertaining whether a Person on Record has failed in discharging his responsibilities in the context of these Rules shall be determined by the Competent Authority and is specified in Schedule No. 2. Penalties for failing to discharge responsibilities shall also be determined by the Competent Authority and are also specified in Schedule No. 2.

3.3 Responsibilities of Individual Persons on Record (POR)

All POR have to jointly certify Technical Audit Report as per Schedule No. 3 for all residential buildings which are 17.5 m or above in height and for all type of non-residential buildings.

3.3.1 Responsibilities of all POR

The overall responsibilities of all POR shall be as follows:

- 1 They shall develop all buildings, which are compatible and accessible to all people and all building shall be designed in such a manner that it must fulfil the requirement of handicapped / disabled people.
- 2 They shall inform the Competent Authority of their resignation from any work within 7 days of the date of such resignation.
- 3 They shall prepare and submit all plans, new or revised as applicable, documents and other details as required, in a neat, clean, and legible manner and on a durable paper properly arranged and folded in accordance with the prevailing Rules along with the soft copy of the same.

- 4 They shall submit plans, documents and details without any scratches or corrections. Only small corrections will be permitted with proper initials. They shall correctly represent all the site conditions including mature trees.
- 5 They shall personally comply with all requisitions / queries received from the Competent Authority in connection with the work under their charge, promptly expeditiously and at one time. Where they do not agree with requisitions/queries, they shall state objections in writing, otherwise for non-compliance of any requisition / query within stipulated time, the plans and applications shall be filed forthwith, and shall not be re-opened.
- 6 They shall immediately intimate to the owners the corrections and other changes they make on the plans, documents, and details as per requisitions / queries from the Competent Authority.
- 7 They shall clearly indicate on every plan, document & submission, the details of their designation such as registered AOR, CEOR, SEOR, COWOR, SOR & QAORF with registration number, date, full name, and their address below the signature for identification.
- 8 They or their authorised agent or employee, shall not accept the employment for preparation and submission of plans - documents and supervision of any work if the same is intended or proposed to be or being executed or already executed in contravention of any Rules or Rules under the Act.
- 9 Approval of drawings and acceptance of any statement, documents, structural report, structural drawings, progress certificate, or building completion certificate shall not charge owner, engineer, architect, clerk of work, supervisor and structural designer, developer, owner, from the irresponsibility's, imposed under the Act, the development Rules and the law of tort and local acts.

Specific responsibilities shall be follows:

3.3.2 Architect on Record (abbreviated as AOR)

The Architect on Record shall:

- 1 Be the Person on Record responsible for ensuring compliance with all procedural requirements specified in these Rules.
- 2 Scrutinize and verify the architectural design and specifications of the proposed building.
- 3 Certify that the architectural design and specification of the proposed building comply with these Rules using the format prescribed in Form No. 2.
- 4 Immediately inform the Competent Authority in writing, if in his/her pinion, the construction of the building is not being undertaken in accordance with the sanctioned design requirement in a format as per Form No. 3.
- 5 Inform the Competent Authority in writing, within 7 working days, if for any reason he/she is relieved of his/her responsibilities or he/she relieves himself of responsibility as the Architect on Record for the building using the format prescribed in Form No. 4. In case of termination of services as Architect on Record, inform the Competent Authorities about the stage of work at which services are terminated. The registered architect appointed as of the preceding architect shall inform within 7 days about his/her appointment on the job and inform the Competent Authority of any deviation that might have occurred on the site with reference to the approved drawings and the stage at which he/she is taking over the charge. After Competent Authority has inspected the site for his/her report, the newly appointed architect shall allow the work to proceed under his/her direction.
- 6 On behalf of the owner, submit the progress certificates, completion certificates and obtain the Occupancy Certificate as required under these Rules.
- 7 Inform the Competent Authority immediately on termination of the services of the SEOR or COWOR and shall not allow the work to continue till the vacancy is filled by appointment of another person and the certificate of appointment of such person is submitted in the Competent Authority within 7 days of his appointment.
- 8 Instruct the relevant agency that adequate provisions are made for ensuring the safety of workers and others during excavation, construction, and erection.
- 9 Instruct the relevant agency that adequate provisions are made for providing safe and adequate temporary structures required for construction and development.

3.3.3 Civil Engineer on Record (abbreviated as CEOR)

The Civil Engineer on Record shall:

- 1 Be the Person on Record responsible for ensuring compliance with all procedural requirements specified in these Rules.
- 2 Scrutinize and verify the structural design and specifications of the proposed building.
- 3 Certify that the structural design and specification of the proposed building comply with these Rules using the format prescribed in Form No. 2.
- 4 Immediately inform the Competent Authority in writing, if in his/her opinion, the construction of the building is not being undertaken in accordance with the sanctioned design requirements, in the format stipulated in Form No. 3.
- 5 Inform the Competent Authority in writing, within 7 working days, if for any reason he/she is relieved of his/her responsibilities or he/she relieves himself/herself of responsibility as the Civil Engineer on Record for the building using the format prescribed in Form No. 4. In case of termination of services as Civil Engineer on Record, inform the Competent Authority about the stage of work at which services are terminated. The registered Civil Engineer appointed as replacement of the preceding Engineer shall inform within 7 days about his / her appointment on the job and inform the Competent Authority of any deviation that might have occurred on the site with reference to the approved drawings and the stage at which he / she is taking over the charge. After Competent Authority has inspected the site for his/her report, the newly appointed Civil Engineer shall allow the work to proceed under his/her direction.
- 6 On behalf of the owner, submit the progress certificates, completion certificates and obtain the Occupancy Certificate as required under these Rules.
- 7 Inform the Competent Authority immediately on termination of the services of the Structural Engineer on Record or Clerk of Works on Record and shall not allow the work to continue till the vacancy is filled by appointment of another person and the certificate of appointment of such person is submitted in the Competent Authority within 7 days of his appointment.
- 8 Instruct the relevant agency that adequate provisions are made for ensuring the safety of workers and others during excavation, construction, and erection.
- 9 Instruct the relevant agency that adequate provisions are made for providing safe and adequate temporary structures required for construction and development.

3.3.4 Structural Engineer on Record (abbreviated as SEOR)

The Structural Engineer on Record shall:

- 1 Scrutinize and verify the structural design and specifications of the proposed building.
- 2 Prepare a report of the structural design.
- 3 Supply two copies of structural drawings to the COWOR
- 4 Advise the Owner/Architect/Clerk of Works for arranging for tests and their reports for soil, building material etc. for his evaluation and design consideration.
- 5 Submit the certificate of structural safety and over all structural soundness of the proposed building and its compliance to the Rules to Competent Authority using the format prescribed in Form No. 2.
- 6 To prepare detailed structural design and to prescribe the method and technique of its execution strictly on the basis of the National Building Code or relevant Indian Standard specifications.
- 7 Detailed structural drawings and specifications for execution indicating thereon, design live loads, safe soil bearing capacity, specifications of material, assumptions made in design, special precautions to be taken by contractor to suit the design assumptions etc. whatever applicable.
- 8 Immediately inform the Competent Authority in writing, if in his opinion, construction of the building is not being undertaken in accordance with the structural design and specifications stipulated by him, in the format stipulated in Form No. 3
- 9 In case of serious default, be blacklisted / de-registered by the Competent Authority
- 10 Inform the Competent Authority in writing, within 7 working days, if for any reason he is relieved of his responsibilities as the Structural Engineer on Record for the building, using the format prescribed in Form No. 4

3.3.5 Clerk of Works on Record (abbreviated as COWOR)

The Clerk of Works on Record shall:

- 1 Undertake all necessary measures, including but not limited to, adequate inspection during construction to ensure that the construction of the building is undertaken as per detailed design and specifications stipulated by the AOR and by the SEOR
- 2 Immediately inform the Competent Authority in writing, if in his opinion, the construction of the building is not being undertaken in accordance with the sanctioned design and specifications, in the format stipulated in Form No. 3.
- 3 Bring to the notice of the SEOR and AOR / EOR any situation or circumstances which in his opinion are liable to endanger the safety of structure.
- 4 Inform the Competent Authority in writing, within 7 working days, if for any reason he is relieved of his responsibilities or he relieves himself of responsibility as the Clerk of Works for the building using the format prescribed in Form No. 4. In case of termination of services as Clerk of Works, inform the Competent Authorities about the stage of work at which services are terminated. The registered Clerk of Works appointed as replacement of the preceding Clerk of Works shall inform within 7 days about his appointment on the job and inform the Competent Authority of any deviation that might have occurred on the site with reference to the approved drawings and the stage at which he is taking over the charge. After Competent Authority has inspected the site for his report, the newly appointed architect shall allow the work to proceed under his direction.
- 5 On behalf of the owner, submit the progress certificates, completion certificates and obtain the Occupancy Certificate as required under the Rules.
- 6 Deposit with the Competent Authority one set of working drawings of the works executed along with the progress certificates before proceeding to the next stage of the work.
- 7 Inform the Competent Authority immediately on termination of the services of any of Person on Record and shall not allow the work to continue till the vacancy is filled by appointment of another person and the certificate of appointment of such person is submitted to the Competent Authority within 7 days of his/her appointment.
- 8 Instruct the relevant agency that adequate provisions are made for ensuring the safety of workers and others during excavation, construction, and erection.
- 9 Instruct the relevant agency that adequate provisions are made for providing safe and adequate temporary structures required for construction and development.
- 10 Take adequate measures to ensure that no damage is caused to the work under construction and the adjoining properties.
- 11 Ensure that no undue inconvenience is caused in the course of his work to the people in neighbourhood.
- 12 Ensure that no nuisance is caused to traffic and neighbouring people by way of noise, dust, smell, vibration etc., in the course of the work.
- 13 Not be permitted to supervise more than ten independent building units at a given time as provided in these General Development Rules.
- 14 Be considered as Supervisor until the issue of building use permission.

3.3.6 Supervisor of Works on Record (abbreviated as SOR)

The Supervisor of Works on Record shall:

- 1 Undertake all necessary measures, including but not limited to, adequate inspection during construction to ensure that the construction of the building is undertaken as per detailed design and specifications stipulated by the AOR and by the SEOR and instruction given by COWOR.
- 2 Immediately inform the developer and Competent Authority in writing, if in his opinion, the construction of the building is not being undertaken in accordance with the sanctioned design and specifications, in the format stipulated in Form No. 3.
- 3 Bring to the notice of the SEOR and AOR/CEOR/COWOR any situation or circumstances which in his opinion are liable to endanger the safety of structure.
- 4 Inform the Competent Authority in writing, within 7 working days, if for any reason he is relieved of his responsibilities or he relieves himself of responsibility as the supervisor of Works for the building using the format prescribed in Form No. 4. In case of termination of

services as Supervisor of Works, inform the Competent Authorities about the stage of work at which services are terminated. The registered Supervisor of Works appointed as replacement of the preceding supervisor of Works shall inform within 7 days about his appointment on the job, and inform the Competent Authority of any deviation that might have occurred on the site with reference to the approved drawings and the stage at which he is taking over the charge. After Competent Authority has inspected the site for his report, the newly appointed architect shall allow the work to proceed under his direction.

- 5 Instruct the relevant agency that adequate provisions are made for ensuring the safety of workers and others during excavation, construction, and erection.
- 6 Instruct the relevant agency that adequate provisions are made for providing safe and adequate temporary structures required for construction and development.
- 7 Take adequate measures to ensure that no damage is caused to the work under construction and the adjoining properties.
- 8 Ensure that no undue inconvenience is caused in the course of his work to the people in neighbourhood.
- 9 Ensure that no nuisance is caused to traffic and neighbouring people by way of noise, dust, smell, vibration etc., in the course of the work.
- 10 Not be permitted to supervise more than two independent building units at a given time as provided in General Development Rules within 500 m peripheral area of each site.
- 11 Be considered as Supervisor, until the issue of building use permission.

3.3.7 Qualified Agency on Record for Fire (abbreviated as QAORF)

The Qualified Agency on Record for Fire shall be required for all buildings listed in Schedule No. 4 and shall:

- 1 Undertake all necessary measures, including but not limited to, adequate inspection during construction to ensure that the construction of the building is undertaken as per detailed design and specifications stipulated by the AOR and by the SEOR.
- 2 Certify that the design and specification of the proposed building comply with Fire Rules in Part 3 (II) and The Dadra and Nagar Haveli and Daman & Diu Fire and Emergency Service Regulation, 2021 as amended from time to time using the format prescribed in Form No. 2.
- 3 Immediately inform the Competent Authority in writing, if in his opinion, the construction of the building is not being undertaken in accordance with the sanctioned design and specifications stipulated by the AOR or CEOR and the SEOR, using the format prescribed in Form No. 3.
- 4 Bring to the notice of the SEOR and AOR or CEOR any situation or circumstances which in his opinion are liable to endanger the fire protection and safety of structure.
- 5 Inform the Competent Authority in writing, within 7 working days, if for any reason he is relieved of his responsibilities or he relieves himself of responsibility as the QAORF for the building using the format prescribed in Form No. 4. In case of termination of services as Qualified Agency on Record on Record for Fire, inform the Competent Authorities about the stage of work at which services are terminated. The registered QAORF appointed as replacement of the preceding QAORF shall inform within 7 days about his appointment on the job and inform the Competent Authority of any deviation that might have occurred on the site with reference to the approved drawings and the stage at which he is taking over the charge. After Competent Authority has inspected the site for his report, the newly appointed architect shall allow the work to proceed under his direction.
- 6 Instruct the relevant agency that adequate provisions are made for fire prevention and safety during construction and development.

4 Development Permission

4.1 Development Permission Required

As specified u/s 43 of The Dadra and Nagar Haveli and Daman and Diu Town & Country Planning Act, 1974 as amended from time to time, no person shall undertake any development without obtaining a Development Permission in writing, prior to commencement of development.

A Development Permission shall mean a Direct Development Permission issued either by an Architect on Record / Civil Engineer on Record or a Development Permission granted by the Competent Authority.

In consonance with the provision of section 49 of The Dadra and Nagar Haveli and Daman and Diu Town & Country Planning Act, 1974 as amended from time to time, these Rules shall be followed by every Authority for granting Permission for subdivision or amalgamation of land.

4.2 Development Permission Not Required

- 1 No development permission shall be required for undertaking minor alterations and works in all buildings as listed below.
 - a) Plastering and patch repairs.
 - b) Whitewashing, painting, and coating of building surfaces.
 - c) Construction of non-load bearing false ceilings.
 - d) Flooring and re-flooring.
 - e) Opening of new doors, windows, and ventilators such that they do not open directly on to adjoining plots.
 - f) Repairing doors and windows in the same location including change in size.
 - g) Rebuilding an existing wall, repairing, and plastering it.
 - h) Changing roof tiles and repairing the roof without increasing the existing room height.
 - i) Repairing an existing staircase.
 - j) Changing or repairing flooring at any floor or height. This only includes wood, stone and metal flooring and does not include RCC flooring.
 - k) Constructing new lofts allowed as per Rules including repairing them.
 - l) Constructing a new toilet block within standalone buildings.
 - m) Construction of water closets.
 - n) Construction of internal non masonry partitions within the building.
 - o) Construction or repair of parapet, railing, compound wall or wire fencing.
 - p) Construction of a water tank or wash area in open area of the building-unit or terrace for residential use only (this does not include building a swimming pool or tanks for commercial use).
 - q) Constructing and repairing weather sheds within the building unit and not projecting on to a public street.
 - r) Installing metal grill in verandah or courtyard.
- 2 Such works shall be carried out only after ascertaining that they are as per these Rules and that the work does not pose any danger, or it does not cause danger to other parts.
- 3 If the construction is falling under road line, then required action, prescribed, is undertaken by an agreement or deposits.
- 4 Works mentioned in Clause 4.2 (1) shall not be permitted without permission of Competent Authority if the area has been declared as an area of special architectural significance by Competent Authority

4.3 Grant of a Development Permission

4.3.1 Grant of a Development Permission

Grant of a development permission does not constitute acceptance of correctness, confirmation, approval, or endorsement of:

- 1 Title, ownership, and easement rights of the building unit for which the development is proposed.
- 2 Variation in area from recorded areas of a building unit.
- 3 Location and boundary of building unit.
- 4 Workmanship, soundness of material and structural safety of the proposed development.
- 5 Structural reports and structural drawings.

And shall not bind or render the Competent Authority liable in any way in regard to (1), (2), (3), (4) and (5) above.

4.3.2 Liability

Notwithstanding any Development Permission granted under the Act and these Rules, any person undertaking any development work shall continue to be wholly and solely liable for any injury or damage or loss whatsoever that may be caused to anyone in or around the area during and after such construction and no liability whatsoever in this regard shall be cast on the Competent Authority or any officer / employee to whom power has been delegated.

4.4 Lapse, Suspension or Cancellation of Development Permission

4.4.1 A Development Permission shall Lapse

- 1 On expiry of time for which the development permission was granted unless the same is extended before such expiry.
- 2 On change in material facts of discovery of new facts related to material aspects of development permission like ownership, developer identity, capacity of owner or developer, misrepresentation of any facts or fraud committed upon the authority etc.

4.4.2 A Development Permission shall stand Suspended

- 1 On change of any person in record unless the factum of such change was communicated to Competent Authority at least 7 days in advance in accordance with these Rules.
- 2 For up to 60 days in total by a notice of the Competent Authority for specific reasons to be communicated in writing to the developer.
- 3 Upon initiation of any disciplinary proceedings against any person on record.
- 4 If the development is not commenced within 12 months of grant of the permission.

4.4.3 A Development Permission shall Stand Cancelled (Form No. 5)

- 1 By an order of the Competent Authority competent to grant the development permission issued after giving the developer / owner a reasonable opportunity of being heard on
 - a) Violation of any condition subject to which the permission was granted.
 - b) On non-fulfilment of any condition or duty imposed by these Rules or the permission which the developer was required to fulfil.

Provided that Architect on record shall not be considered as authority competent to grant Development permission within the meaning of these Rules. For direct development permission, it shall be presumed that appropriate officer of the Competent Authority granted the development permission.

- 2 In a given area by any general order of the government while declaring Town Planning Scheme or any similar scheme.

4.4.4 General Provisions regarding Lapse, Suspension, or Cancellation of the Development Permission

- 1 Development permission may be cancelled even after the grant of Occupancy Certificate if any new fact related to material misrepresentation or violation comes to the knowledge of Competent Authority.
- 2 On cancellation of development permission any development shall become unauthorised, and it shall be presumed that the development was and has always been unauthorised.
- 3 Development permission shall not be cancelled if the same can be regularised on payment of penalties specified in the Schedule No. 5D. That is to say, what can be regularised should be regularised.

4.5 Revision of Development Permission

- 1 Changes or revisions in the sanctioned design and specification of a development may be made provided, that a Revised Development Permission is obtained before construction is undertaken, on the portion of the development that deviates from the Sanctioned Design and Specifications. These may be:
 - a) Change in utilised FSI
 - b) Change in parking area
 - c) Change in orientation / location of the building
 - d) Change in size or location of the Common Plot
 - e) Change in use of building or part thereof
 - f) Change in building unit and or blocks which affects the approved layout.
 - g) Change in Outline Development Plan / Town Planning Scheme which affects building unit and approved buildings / layout.
- 2 Procedures for obtaining a Revised Direct Development Permission and obtaining a Revised Development Permission are specified in Rule No. 4.12 and 4.13 respectively.

4.6 Extension / Revalidation of Development Permission

- 1 A Development Permission may be extended for a period of one year. The extended period shall in no case exceed three years in the aggregate that is for a total period of six years. The period of validity shall begin from the date of development permission. After six years, a fresh Development Permission shall be obtained.
- 2 A suspended Development Permission may be revalidated on payment of penalties / fees as specified in Schedule No. 5D. Any construction done after the permission is suspended shall be deemed to be unauthorised unless the same were regularised as per the Schedule No. 5D.

4.7 Unauthorized Development

4.7.1 Unauthorized Development

Any development undertaken without or in contravention of a valid Development Permission, or during cancellation of or upon cancellation of development permission shall be an Unauthorized Development and shall be deemed to have always been an unauthorised development.

4.7.2 Dealing with Unauthorized Development

- 1 Competent Authority, or such other officer as may have been authorised by it, after conducting and getting a site inspection report, by a written notice in the format prescribed in Form No. 6, require the person undertaking unauthorised development to stop the same forthwith and may further require the person to either get the construction regularised—if the same is possible within these Rules—or to demolish the same within 30 days.

This written notice may be affixed to any part of the premise and shall be deemed a sufficient intimation to the occupier of such building or part of building. If the person carrying out such

work or doing such thing is not the owner at the time of giving such notice, such person shall be liable for obeying the directions of the Competent Authority.

If the construction is not stopped immediately, the Competent Authority, or the authorised officer, shall be entitled to seek help of police and police shall be duty bound to assist the authority or officer in getting the construction stopped. The Competent Authority or the officer, may in its discretion seal the premises to stop such construction from happening.

Competent Authority, or authorised officer may also seek help of local authorities in assisting it in preventing such construction from happening. Local authority shall be duty bound to assist the authority or the officer in discharge of such functions.

If the construction is not capable of being regularised within existing framework of Rules, or if such request is not received within 30 days, or if no reply is received, the Competent Authority, or such other officer as may have been authorised by it: -

- a) Seal or remove the unauthorised construction.
 - b) Recover the cost of such sealing or removal from the person carrying out the development or the owner or both
 - c) Proceed in accordance with Town and Country Planning Act or Municipal Council Regulation and register a criminal complaint against the accused.
- 2 In cases where development has already started/commenced on site without obtaining Development Permission, but where this development is in accordance with these Rules, the Competent Authority may grant development permission on the merits. For such development, considering it to unauthorised penalty, as specified in Schedule No. 5D shall be charged in addition to other fees / charges/ deposits etc.

4.7.3 Undertaking Unauthorized Development to be a Cognizable Offence

As provided for u/s 50(A) of the Act, undertaking an Unauthorised Construction is a cognizable offence to which the Code of Criminal Procedure, 1973 shall apply, and an Owner undertaking such construction may face prosecution(s) under provisions of section 51 of the Act.

4.8 Relaxation, Interpretation and Conflict Resolution Mechanism

4.8.1 Grant of Relaxation

- 1 “Grant of Relaxation” means grant of permission to deviate from these Rules / specific Rule.
- 2 The Prescribed Authority may for reasons to be recorded in writing, in cases of public interest grant relaxation to the government or any local authority or a government owned autonomous body in respect of any development permission. However, any relaxation shall not compromise fire and structural safety requirements of the building / development.
- 3 Except for the authority mentioned above, and conditions mentioned above, no other relaxation from the operations of these Rules, except as provided in the schedule shall be granted by any authority to any applicant.

4.8.2 Prescribed Authority to Clarify and Interpret Provisions of the Rules

Prescribed Authority, or such officer or committee as shall clarify or interpret provisions of these Rules, as specified below. Clarifications or interpretations made by the Competent Authority shall be final and binding.

- 1 Decide on matters where it is alleged that there is an error in any order, requirement, decision or determination made by any Competent Authority under delegation of powers in Rules or interpretation in the application of these Rules.
- 2 Interpretation of road alignment as per site situation.
- 3 Authorize the erection of a building or the use of premises for a public service undertaking for public utility purposes only, where it finds such an authorization to be reasonably necessary for the public convenience and welfare, even if it is not permitted in any land use zone classification.

4.8.3 Conflict Resolution Mechanism and Appeals against unauthorised development and refusal to grant development permission or occupancy certificate.

- 1 Prescribed authority, or any officer or committee authorised by it, shall be authorised to hear appeal against notices of unauthorised construction, refusal to grant or grant of any occupancy certificate or development permission.
 Provided that different officers or committees may be appointed by the prescribed authority to hear different appeals.
 Provided further that all such appeals shall be deemed to have been heard by the prescribed authority and shall be deemed to have always been heard by the prescribed authority.

Table No. 4.1: Fee for Appealing Before Prescribed Authority

No.	Members	Designation
1	Against unauthorised development	Rs 1 /sq m of Built-Up Area
2	Against Grant or Refusal to Grant Development Permission or Occupancy Certificate	Same as Scrutiny Fees
3	Against Any other Order	Rs. 10000

- 2 All authorities in the territory shall be bound by the interpretation or the decision of the prescribed authority.

4.9 Penalties

Any person contravening any of the Rules or Provisions of the Outline Development Plan shall on such contravention be liable to a punishment as provided in the [Dadra and Nagar Haveli], Daman and Diu Town & Country Planning Act, 1974, amended from time to time, and Rules framed there under as in force from time to time.

4.10 Obtaining Direct Development Permission

4.10.1 Application, Documents and Registration

- 1 Development may be commenced by the owner under the following conditions, without seeking Development Permission from the Competent Authority and it shall be treated as Direct Development Permission:
 - a) If the building unit size is up to 500 sq m and built-up area is up to 300 sq m.
 - b) Development shall not exceed a maximum height of 10 m.
 - c) Development is for self-use and meant for residential purpose only.
- 2 Architect on Record / Civil Engineer on Record in the format prescribed in Form No. 7, certifies that the proposed development complies with these Rules shall be deemed to be a Development Permission granted by the Competent Authority.
- 3 It shall be the responsibility of the Architect on Record / Civil Engineer on Record issuing the Direct Development Permission to register the same with the Competent Authority within 15 working days of issue of Direct Development Permission. Format of Application for Registering Issue of Direct Development Permission is prescribed in Form No. 8.
- 4 Before grant of such permission the Architect / Civil Engineer shall ensure that the grant of permission is not in contravention of any information or direction of the Competent Authority published on such notice board or such website as may be notified by the Competent Authority from time to time.
- 5 The plans and documents, in duplicate, to be submitted along with registration of Direct Development Permission application to the Competent Authority are prescribed in Schedule No. 6A and Schedule No. 6D. The format for submission of drawings, specifications and documents is specified in Schedule No. 6C.

4.10.2 Fees and Charges

All fees and charges for obtaining a direct development permission are listed in Schedule No. 5A. The fees and charges shall be determined by the Competent Authority from time to time.

4.10.3 Scrutiny of Application, Registration or Refusal of Direct Development Permission

- 1 The Competent Authority may undertake scrutiny of the application for registering issue of Direct Development Permission.
- 2 The Competent Authority shall communicate the registration of issue of the Direct Development Permission, to the Architect on Record / Civil Engineer on Record, within 15 working days of date of receipt of application using the format prescribed in Form No. 9.
- 3 Issuance of Form No. 9, by the Competent Authority shall mean that the issue of the Direct Development Permission has been registered by the Competent Authority.
- 4 In the event that the Competent Authority does not issue Form No. 9 within a period of 15 working days of date of receipt of application, it shall be deemed that the Competent Authority has registered the issue of the Direct Development Permission.
- 5 In the event that the Competent Authority refuses the Direct Development Permission, it shall communicate the reasons for refusal to the AOR within 15 working days from the date of receipt of application, using the format specified in Form No. 9.
- 6 The Competent Authority shall handover the second copy of plan to the applicant duly acknowledged, which shall be kept for inspection on site.

4.10.4 Penalties

Any development undertaken shall be in conformity of these Rules. Financial penalty, for different conditions of commencement, shall be levied as prescribed in Schedule Rule No. 4.8 and Schedule No. 5D for unauthorised development.

4.11 Obtaining Development Permission**4.11.1 Application**

- 1 A owner / developer may make an application for development / building / layout / subdivision / amalgamation on a building unit / plot using Form No. 10A. Application for brick kiln, mining and quarrying on a building unit / plot using Form No. 10B.
- 2 Drawings, specifications, and documents to be submitted along with Application for obtaining a Development Permission shall be determined by the Competent Authority. These are prescribed in Schedule No. 6A for buildings or for Subdivision or/ and Amalgamation, Schedule No. 6B for Brick Kiln, Mining and Quarrying and Schedule No. 6D for Temporary Construction. The format for submission of drawings, specifications and documents is specified in Schedule No. 6C.
- 3 The receipt of the different fees and charges leviable under the Act and these Rules shall also be attached with the application.
- 4 The Application may be done either online or offline as may be directed by the Competent Authority from time to time.
- 5 The Competent Authority may as per time-to-time direction of the Government or otherwise adopt, for the scrutiny of development permission applications, an automated scrutiny system.

4.11.2 Fees and Charges

All fees and charges for obtaining a development permission are listed in Schedule No. 5A. The fees and charges shall be determined by the Competent Authority from time to time.

4.11.3 Scrutiny of Application, Grant, or Refusal of a Development Permission

- 1 Within thirty days from the date of payment of the Fees and Charges, and receipt of an application for development permission, either by electronic mode with digital authentic signature of all concerned persons on record or in physical mode the Competent Authority shall, as deemed fit, make an inquiry and scrutiny of the application for compliance with respect to

these Rules. The Competent Authority may utilise the automated building plan approval system for scrutiny of application. The Competent Authority after carrying out required scrutiny, shall:

- a) Communicate to the applicant in writing by a letter to furnish documents or clarify or ask for compliance in matters arising out of the scrutiny or
 - b) If satisfied about the compliance, may be issue orders, in the format of Form No. 12, granting the permission, with or without conditions or subject to any general or special orders, made by the State Government in this behalf or
 - c) Refuse to grant permission with reasons.
- 2 For any decision under Clause 4.11.3 (1a) above, in cases where the building design requirements are as per these Rules, but the co-owner of the property or Chairman / Secretary of the Cooperative Society are not giving consent at the time of development permission, the Competent Authority may issue permission after giving opportunity of hearing to the co - owner of the property or Chairman / Secretary of the Cooperative Society considering the merits and demerits of individual case.

4.11.4 Penalties

Any development undertaken shall be in conformity of these Rules. Financial penalty, for different conditions of commencement, shall be levied as prescribed in Schedule Rule No. 4.8 and Schedule No. 5D for unauthorised development.

4.12 Revising a Direct Development Permission

4.12.1 Application, Documents and Registration

- 1 Architect on Record / Civil Engineer on Record in the format prescribed in Form No. 13, certifies that the revisions to the sanctioned design and specifications comply with these Rules shall be deemed to be a Revised Direct Development Permission granted by the Competent Authority.
- 2 It shall be the responsibility of the Architect on Record / Civil Engineer issuing the Revised Direct Development Permission to register the same with the Competent Authority within 15 working days of issue of Revised Direct Development Permission. Format of Application for Registering Issue of Revised Direct Development Permission is prescribed in Form No. 14.
- 3 The plans and documents, in duplicate, to be submitted along with registration of Direct Development Permission application to the Competent Authority are prescribed in Schedule No. 6A and Schedule No. 6D. The format for submission of drawings, specifications and documents is specified in Schedule No. 6C.

4.12.2 Fees and Charges

All fees and charges for obtaining a revised development permission are listed in Schedule No. 5A. The fees and charges shall be determined by the Competent Authority from time to time.

4.12.3 Scrutiny of Application, Registration or Refusal of Revised Direct Development Permission

- 1 The Competent Authority may undertake scrutiny of the application for registering issue of Revised Direct Development Permission.
- 2 The Competent Authority shall communicate the registration of issue of the Revised Direct Development Permission, to the Architect on Record, within 15 working days of date of receipt of application using the format prescribed in Form No. 9.
- 3 Issuance of Form No. 9, by the Competent Authority shall mean that the issue of the Revised Direct Development Permission has been registered by the Competent Authority.
- 4 In the event that the Competent Authority does not issue Form No 9 within a period of 15 working days of date of receipt of application, it shall be deemed that the Competent Authority has registered the issue of the Revised Direct Development Permission.

- 5 In the event that the Competent Authority refuses the Revised Direct Development Permission, it shall communicate the reasons for refusal to the AOR / EOR within 15 working days from the date of receipt of application, using the format specified in Form No. 9.
- 6 The Competent Authority shall handover the second copy of plan to the applicant duly acknowledged, which shall be kept for inspection on site.

4.12.4 Penalties

Any development undertaken shall be in conformity of these Rules. Financial penalty, for different conditions of commencement, shall be levied as prescribed in Schedule Rule No. 4.8 and Schedule No. 5D for unauthorised development.

4.13 Revising Development Permission

4.13.1 Application

- 1 Application for Revising a Development Permission shall be made by the Owner of the plot on which the development is proposed, in the format prescribed in Form No. 15.
- 2 Drawings, specifications, and documents to be submitted along with Application for Obtaining a Revised Development Permission shall be determined by the Competent Authority. These are prescribed in Schedule No. 6A for Building or for Sub-division or/ and Amalgamation, Schedule No. 6B for Brick Kiln, Mining and Quarrying and Schedule No. 6D for Temporary Construction. The format for submission of drawings, specifications and documents is specified in Schedule No. 6C.
- 3 The receipt of the different fees and charges leviable under the Act and these Rules shall also be attached with the application.
- 4 The Application may be done either online or offline as may be directed by the Competent Authority from time to time.
- 5 The Competent Authority may as per time-to-time direction of the Government or otherwise adopt, for the scrutiny of development permission applications, an automated scrutiny system.

4.13.2 Fees and Charges

All fees and charges for obtaining a revised development permission are listed in Schedule No. 5A. The fees and charges shall be determined by the Competent Authority from time to time.

4.13.3 Scrutiny of Application, Grant, or Refusal of a Revised Development Permission

- 1 Within thirty days from the date of payment of the Fees and Charges, and receipt of an application for revised development permission, either by electronic mode with digital authentic signature of all concerned persons on record or in physical mode the Competent Authority shall, as deemed fit, make an inquiry and scrutiny of the application for compliance with respect to these Rules. The Competent Authority may utilise the automated building plan approval system for scrutiny of application. The Competent Authority after carrying out required scrutiny, shall:
 - a) Communicate to the applicant in writing by a letter to furnish documents or clarify or ask for compliance in matters arising out of the scrutiny or
 - b) If satisfied about the compliance, may be issue orders, in the format of Form No. 15, granting the revised development permission, with or without conditions or subject to any general or special orders, made by the State Government in this behalf or
 - c) Refuse to grant revised development permission with reasons.

4.13.4 Penalties

Any development undertaken shall be in conformity of these Rules. Financial penalty, for different conditions of commencement, shall be levied as prescribed in Schedule Rule No. 4.8 and Schedule No. 5D for unauthorised development.

4.14 Revalidating a Lapsed / Suspended Direct Development Permission

4.14.1 Application, Documents and Registration

- 1 Architect on Record / Civil Engineer on Record in the format prescribed in Form No. 16, certifies that the lapsed Direct Development permission is revalidated and complies with these Rules shall be deemed to be a Revalidated Direct Development Permission granted by the Competent Authority.
- 2 It shall be the responsibility of the Architect on Record / Civil Engineer issuing the Revalidated Direct Development Permission to register the same with the Competent Authority within 15 working days of issue of Revalidated Direct Development Permission. Format of Application for Registering Issue of Revised Direct Development Permission is prescribed in Form No. 17.
- 3 The plans and documents, in duplicate, to be submitted along with registration of Direct Development Permission application to the Competent Authority are prescribed in Schedule No. 6A and Schedule 6D. The format for submission of drawings, specifications and documents is specified in Schedule No. 6C.

4.14.2 Fees and Charges

All fees and charges for obtaining a revised development permission are listed in Schedule No. 5A. The fees and charges shall be determined by the Competent Authority from time to time.

4.14.3 Scrutiny of Application, Registration or Refusal of Revised Direct Development Permission

- 1 The Competent Authority may undertake scrutiny of the application for registering issue of Revalidated Direct Development Permission.
- 2 The Competent Authority shall communicate the registration of issue of the Revalidated Direct Development Permission, to the Architect on Record, within 15 working days of date of receipt of application using the format prescribed in Form No. 9.
- 3 Issuance of Form No. 9, by the Competent Authority shall mean that the issue of the Revalidated Direct Development Permission has been registered by the Competent Authority.
- 4 In the event that the Competent Authority does not issue Form No. 9 within a period of 15 working days of date of receipt of application, it shall be deemed that the Competent Authority has registered the issue of the Revised Direct Development Permission.
- 5 In the event that the Competent Authority refuses the Revalidated Direct Development Permission, it shall communicate the reasons for refuses to the AOR within 15 working days from the date of receipt of application, using the format specified in Form No. 9.
- 6 The Competent Authority shall handover the second copy of plan to the applicant duly acknowledged, which shall be kept for inspection on site.

4.14.4 Penalties

Any development undertaken shall be in conformity of these Rules. Financial penalty, for different conditions of commencement, shall be levied as prescribed in Schedule Rule No. 4.8 and Schedule No. 5D for unauthorised development.

4.15 Revalidating a Lapsed /Suspended Development Permission

4.15.1 Application

- 1 Application for Revalidating Lapsed /Suspended Development Permission shall be made by the Owner / Developer of the building units on which the development is proposed, in the format prescribed in Form No. 18.
- 2 Drawings, specifications, and documents to be submitted along with Application for Obtaining a Revalidated Development Permission shall be determined by the Competent Authority. These are prescribed in Schedule No. 6A for Building or for Sub-division or/ and Amalgamation, Schedule No. 6B for Brick Kiln, Mining and Quarrying and Schedule No. 6D for Temporary

Construction. The format for submission of drawings, specifications and documents is specified in Schedule No. 6C.

- 3 The receipt of the different fees and charges leviable under the Act and these Rules shall also be attached with the application.
- 4 The Application may be done either online or offline as may be directed by the Competent Authority from time to time.
- 5 The Competent Authority may as per time-to-time direction of the Government or otherwise adopt, for the scrutiny of development permission applications, an automated scrutiny system.

4.15.2 Fees and Charges

All fees and charges for revalidating development permission are listed in Schedule No. 5A. The fees and charges shall be determined by the Competent Authority from time to time.

4.15.3 Scrutiny of Application, Grant, or Refusal of a Lapsed Development Permission

- 1 Within thirty days from the date of payment of the Fees and Charges, and receipt of an application for development permission, either by electronic mode with digital authentic signature of all concerned persons on record or in physical mode the Competent Authority shall, as deemed fit, make an inquiry and scrutiny of the application for compliance with respect to these Rules. The Competent Authority may utilise the automated building plan approval system for scrutiny of application. The Competent Authority after carrying out required scrutiny, shall:
 - a) Communicate to the applicant in writing by a letter to furnish documents or clarify or ask for compliance in matters arising out of the scrutiny or
 - b) If satisfied about the compliance, may be issue orders, in the format of Form No. 12, granting the permission, with or without conditions or subject to any general or special orders, made by the State Government in this behalf or
 - c) Refuse to grant permission with reasons.
- 2 For any decision under Clause 4.15.3 (1a) above, in cases where the building design requirements are as per these Rules, but the co-owner of the property or Chairman / Secretary of the Cooperative Society are not giving consent at the time of development permission, the Competent Authority may issue permission after giving opportunity of hearing to the co - owner of the property or Chairman / Secretary of the Cooperative Society considering the merits and demerits of individual case.

4.15.4 Penalties

Any development undertaken shall be in conformity of these Rules. Financial penalty, for different conditions of commencement, shall be levied as prescribed in Schedule Rule No. 4.8 and Schedule No. 5D for unauthorised development.

4.16 Temporary Construction Permission

4.16.1 Application

- 1 Application for Temporary Construction Permission shall be made by the Owner / Developer of the building units on which the Temporary Construction is proposed, in the format prescribed in Form No. 10C.
- 2 Drawings, specifications, and documents to be submitted along with Application for Obtaining a Temporary Construction Permission shall be determined by the Competent Authority. The format for submission of drawings, specifications and documents is specified in Schedule No. 6D. The format for submission of drawings, specifications and documents is specified in Schedule No. 6C.
- 3 The receipt of the different fees and charges leviable under the Act and these Rules shall also be attached with the application.
- 4 The Application may be done either online or offline as may be directed by the Competent Authority from time to time.

- 5 The Competent Authority may as per time-to-time direction of the Government or otherwise adopt, for the scrutiny of development permission applications, an automated scrutiny system.

4.16.2 Fees and Charges

All fees and charges for revalidating development permission are listed in Schedule No. 5C. The fees and charges shall be determined by the Competent Authority from time to time.

4.16.3 Scrutiny of Application, Grant, or Refusal of Permission

- 1 No temporary construction shall be permitted, without obtaining prior approval of the Competent Authority or any authorised officer for the said purpose who may grant such permissions subject to such conditions as may be deemed necessary.
- 2 The Competent Authority may grant permission for temporary construction for a period not exceeding a period of one year.
- 3 Temporary Construction may be granted on following cases:
 - a) Structures for protection from the rain or covering of the terraces during monsoon only
 - b) Pandals for fairs, ceremonies, religious functions, etc. Pandal” means a temporary structure with a roof or walls made of straw, hay, ulu grass, golpatta, hogla, darma, mat, canvas, cloth or other like material.
 - c) Structures of exhibitions/ circuses etc
 - d) Structures for ancillary works for quarrying operations in conforming zones.
 - e) Government booths and temporary shelters.
 - f) Transit accommodation for persons to be rehabilitated in a new construction.
 - g) Structures for educational and medical facilities within the site of the proposed building during the phase of planning and constructing the said permanent buildings.
 - h) Ready mix concrete plant.
- 4 Temporary constructions for structures etc. mentioned at (f), (g) and (h) may be permitted to be continued temporarily by the Authority, but in any case, not beyond completion of construction of the main structure or building and that, structure in (d) and (e) may be continued on annual renewal basis by the Authority beyond a period of one year.

4.16.4 Penalties

Financial penalty shall be levied as prescribed in Schedule Rule No. 4.8 and Schedule No. 5D if the structures in not removed within the time it is granted permission for.

5.0 Procedure During Construction

5.1 Inspection of Construction

5.1.1 Inspection of Construction at Any Time

- 1 All buildings / development for which development permission is required, are subject to inspection by the Competent Authority and the Competent Authority reserves the right to inspect such buildings at any time during the period of Construction without giving prior notice of its intention to do so.
- 2 Owner of the building unit and / or any person undertaking construction shall permit authorized officers of the Competent Authority to enter the building unit and inspect the building for the purpose of enforcing these Rules.
- 3 No inspection of a residential premise shall be done after sunset and before sunrise without sufficient cause and without giving a reasonable opportunity of being heard.

5.1.2 Inspection where Direct Development Permission is Issued

- 1 All building / developments for which Direct Development Permission has been issued shall be subject to random inspection by the Competent Authority during construction.
- 2 It shall be the responsibility of the Architect on Record / Engineer on Record and the Clerk of Works on Record for the development to report commencement, progress at various stages, and completion of construction to the Competent Authority as specified in Rule No. 5.5.

5.1.3 Inspection where Development Permission is Granted

- 1 All buildings for which development permission has been granted shall be subjected to periodic inspection by the Competent Authority during construction.
- 2 It shall be the responsibility of the Owner, the Architect on Record or Engineer on Record, and the Clerk of Works on Record for the building to report commencement, progress at various stages, and completion of construction to the Competent Authority as specified in Rule No. 5.5.

5.1.4 Inspection for Fire Safety and Protection of Building under Construction

For buildings listed in Schedule No. 4, the Fire Officer shall carry out inspections at appropriate intervals, to ensure that the fire protection requirements and measures for such building under construction are adequate and operational. Fire Officer shall also satisfy himself that all elevators including fire lifts are duly tested and their test certificates are submitted to his satisfaction. If the above work is entrusted to a registered Qualified Agency on Record for Fire, his reports shall be countersigned by the Fire Officer.

In case of inadequacy of these Rules, he shall issue a notice to the owner or occupier of such building directing him to rectify the shortcomings /contraventions within a specified period. Copies of all such notices shall also be endorsed by the Competent Authority.

5.2 Information to be Prominently Displayed on Site

- 1 It shall be the responsibility of the Clerk of Works on Record and the Owner to erect a notice board on the building unit displaying key information pertaining to the building/development within 15 working days from the grant or issue of development permission.
- 2 Specifications for notice board and the information to be displayed are specified in Schedule No. 7A.
- 3 The notice board should be prominently visible, easily readable and should be located next to the primary access to the building unit. More than one notice board may be erected.
- 4 The notice board/s should be maintained for the entire period of construction / development up to issue or grant of occupancy certificate.

- 5 Failure to comply with this Rule may result in cancellation of the development permission. Penalties leviable on the Clerk of works on Record for not displaying the necessary information are stipulated in Schedule No. 7A.

5.3 Documents and Drawings to be Maintained on Site

- 1 It shall be the responsibility of the Clerk of Works on Record and the Owner for the building to keep all the documents and drawings listed in Schedule No. 7B on the site, at all times after issuing notice of commencement of construction to the Competent Authority up to the issue or grant of occupancy certificate.
- 2 These documents should be made available to any authorised officer of the Competent Authority inspecting the site for the purpose of enforcing these Rules.
- 3 Failure to comply with this Rule may result in cancellation of the development permission. Penalties leviable on the Clerk of works on Record for not displaying the necessary information are stipulated in Schedule No. 5A.

5.4 Reducing Inconvenience and Ensuring Safety during Construction

5.4.1 Stacking, Storing and Disposal of Building Material

- 1 The stacking of building materials, sand debris on public roads, highways shall be prohibited.
- 2 It shall be the responsibility of the Clerk of Works on Record and the Owner / Developer to ensure that no building material, building equipment or building debris is stacked, stored, left or disposed off, outside the building unit for which development permission has been granted, on any public street or space.
- 3 Permission may be obtained in special circumstances to stack building materials, sand, debris on public roads / highways from the Competent Authority on payment of Deposits and Charges indicated in Schedule No. 5A.

5.4.2 Barricading the Building Unit / Plot during Construction

- 1 It shall be the responsibility of the Architect on Record or Engineer on Record and Clerk of Works on Record to ensure that the plot on which construction is being undertaken is adequately barricaded and safety measures are in place and there is no public inconvenience caused and or safety is compromised.
- 2 Failure to comply with this Rule may result in cancellation of a development permission.

5.4.3 No Damage or Undue Inconvenience during Construction

It shall be the responsibility of the Clerk of Works on Record and the Owner or Developer to undertake all necessary measures to ensure that no

- 1 No damage is caused to adjoining properties due to construction.
- 2 No undue inconvenience is caused to the public, due to factors such as noise, dust, smell, or vibrations.
- 3 No traffic is not disrupted due to construction.
- 4 Failure to comply with this Rule may result in cancellation of a development permission.

5.4.4 Liability for Ensuring during Construction

The Owner or Developer and the Clerk of Works on Record shall be responsible for ensuring that all necessary measures for safety for all are taken on site. Grant of Development Permission, grant of Building Use Permission for part of a building or issuing of any instructions to ensure public safety or reduce inconvenience, does not render the Competent Authority liable for any injury, damage or loss whatsoever that may be caused to anyone in or around the area during the Period of Construction.

5.5 Progress of Construction and Inspection

5.5.1 Notice for Commencement of Construction

- 1 The Owner and the Architect on Record for the building shall notify the Competent Authority their intention to commence construction at least 15 working days prior to commencing construction by filing a Notice of Commencement of Construction, in the format prescribed in Form No. 19.
- 2 The construction shall commence only after the Competent Authority registers the issue of Direct Development Permission by the AOR / EOR.
- 3 Failure to notify the Competent Authority before commencing construction may result in cancellation of the development permission.
- 4 A set of detailed working drawings including structural details based on approved building plans shall be submitted along with the Form No. 19.

5.5.2 Development Permission may Lapse if Construction Not Commenced on Time

Development permission can be extended for one year at a time, provided that there has been no change in the Rules of the construction is in conformity with new Rules. The extended period shall in no case exceed three years. In the aggregate, a development permission cannot remain valid for period of more than six years. After that an application for a new development permission shall be made.

5.5.3 Competent Authority to be Notified of Progress of Construction

The Owner or Developer and the Architect on Record or Engineer on Record shall be responsible for notifying the Competent Authority of progress of construction having been completed up to the stages stipulated in Schedule No. 7C. Notice of Progress of Construction shall be made in the format prescribed in Form No. 20. and approved by the Persons on Record.

The Notice of Progress of Construction shall not be necessary in the following cases:

- 1 Alteration in building not involving the structural part of the building.
- 2 Extension of existing residential building on the ground floor up to maximum area of 40 sqm.

On receipt of the Notice of Progress of Construction from the owner or developer, it shall be the duty of the Competent Authority, if necessary, to check any deviation from the sanctioned plan and convey decision within 7 days to the owner or developer accordingly for compliance.

5.6 Inspections

- 1 The Competent Authority shall carryout the inspection of construction based on the 'risk' posed by the development. Any development carried out by the owner, or the developer attracts risk during the design and construction. Risk is defined as the likelihood of non- compliance with building regulations and the potential extent of harm to current and future users of building and the environment associated with non-compliance.
- 2 The different Risk Consequence Classes (CC), along with description of the principles, use groups, design supervision levels (SL) And inspection requirements are indicated in Schedule No. 8
- 3 For the purpose of inspecting the construction at different stages, the Competent Authority may hire the services of the architects / engineers who are registered with the PDA. Schedule No. 8 indicates the experience requirements for such professional to conduct inspections based on the Risk Consequence Classes of buildings / development.
- 4 For this the Competent Authority shall, for the subsequent financial year, latest by 15 March every year invite the applications of architects and engineers who would be willing to work as inspection architect / engineer. On receipt of the applications, Competent Authority shall make a panel of approved engineer / architect. The Competent Authority shall make a contract

agreement with all the engineers / architect included in the panel. The agreement shall include the scope of work, the reporting systems, and the protocols (including penalty Clauses, mode of payments and reporting systems both online and in hard copies) for smooth functioning of inspections.

- 5 The Competent Authority shall decide the fees for each site visit and the site report.

6.0 Occupancy Certificate

6.1 Occupancy Certificate Required

It is mandatory to obtain an Occupancy Certificate from the Competent Authority prior to occupancy or use being made of any development or part of a development.

6.2 Grant of Occupancy Certificate

Grant of Occupancy Certificate by the Competent Authority shall mean an acceptance by the Competent Authority that the development has conformed to the sanctioned design and specifications and that the Owner may use the development in conformity with the Sanctioned Use of the development.

Issue or grant of an Occupancy Certificate does not constitute acceptance of correctness, confirmation, approval or endorsement of and shall not bind or render the Competent Authority liable in any way in regard to:

- 1 Title, ownership, and easement rights of the plot on which development / building is proposed.
- 2 Workmanship, soundness of material and structural safety of the development / building.
- 3 Variation in area from recorded areas of a building unit.
- 4 Location and boundary of building unit.
- 5 Safety of the users of the building.
- 6 NOC from Appropriate Authority.
- 7 Structural reports and structural drawings.

6.3 Cancellation of Occupancy Certificate

- 1 Cancellation of an Occupancy Certificate shall mean that the Occupancy Certificate is no longer valid and that the Competent Authority has withdrawn the permission granted to make use of the development. Occupancy Certificate may be revoked for part of a development.
- 2 Occupancy Certificate can be revoked if there is a major change in occupancy and no change of occupancy is sought as per Rule 6.6.
- 3 After Cancellation of Occupancy Certificate, use may no longer be made of the whole of or part of the development for which the Occupancy Certificate has been suspended.
- 4 Notice of Cancellation of an Occupancy Certificate shall be issued by Competent Authority in writing, in the format specified in Form No. 24.

6.4 Unauthorized Use/ Occupancy of Building / Development

- 1 Use of any building or part of a building, without a building use permission or in a manner that does not conform with its permission granted or after issue of building use permission has been revoked, shall be deemed to be unauthorized use of building.
- 2 Also, the Competent Authority may declare the use of any building to be an unauthorized use if it deems the building to be unsafe for habitation or if its use poses a danger to public health or safety.

6.5 Obtaining an Occupancy Certificate

6.5.1 Application

- 1 The Owner and the Architect / Engineer on Record for the building shall be responsible for notifying the Competent Authority of completion of construction, for certifying that the construction complies with the sanctioned design & specifications and applying for grant of Occupancy Certificate.

- 2 Notice of Completion of Construction and Compliance Certification shall be made in the format prescribed in Form No. 21.
- 3 Application for Occupancy Certificate may be made to the Competent Authority in the format stipulated in Form No. 22A and Form No. 22B and shall be accompanied by documents and drawings as prescribed by the Competent Authority in Schedule No. 9. The format for submission of drawings, specifications and documents is specified in Schedule No. 9.
- 4 Application for Occupancy Certificate may be made for part of development also.

6.5.2 Fees and Charges

All fees and charges for obtaining Occupancy Certificate are listed in Schedule No. 5B. The fees and charges shall be determined by the Competent Authority from time to time.

6.5.3 Final Inspection and Grant / Refusal of Occupancy Certificate

The Competent Authority, on receipt of Notice of Completion of Construction and a duly completed application for Occupancy Certificate, shall inspect the constructed building before granting the Occupancy Certificate, to verify its compliance to the sanctioned design and specifications within 21 days from the date of receipt of the application.

If the construction is found not complying with sanctioned design and specifications, the Competent Authority shall communicate queries regarding the construction and / or directions to ensure compliance to the Owner and the Architect on Record or Engineer on Record. Failure to comply with directions, as may be issued by the Competent Authority, may result in cancellation of the Occupancy Certificate. The Architect on Record or Engineer on Record shall respond to queries and notify the Competent Authority of having undertaken compliant modifications.

The final inspection of the work and communication of the decision about the grant of the Building Use Permission shall be made by the concerned Competent Authority within 21 days from the date of receipt of Notice of Completion of Construction and Compliance Certification. If the Competent Authority is satisfied that the construction of the building complies with the sanctioned design and specifications and other requirements as per Schedule No. 8, it shall grant Occupancy Certificate in the format stipulated in Form No. 23. Reasons for grant / refusal of Building Use Permission shall be communicated to the applicant.

In cases where the building construction is as per the Rules, but the owner of the adjoining building or Chairman / Secretary of the Cooperative Society are not giving consent at the time of building use permission, the Competent Authority may issue permission after giving opportunity of hearing to the owner of the adjoining building or Chairman / Secretary of the Cooperative Society considering the merits and demerits of individual case.

6.5.4 Penalties

Any development undertaken shall be in conformity of these Rules. Financial penalty, for different conditions of occupancy, shall be levied as prescribed in Schedule No. 5D for unauthorised use of development.

6.6 Permission to Change Sanctioned Occupancy / Use of Development

6.6.1 Application

- 1 No building or premises shall be changed or converted to a use other than the sanctioned use without prior permission of the Competent Authority in writing. Change of use not in conformity with these Rules shall not be permissible.
- 2 Application for obtaining Permission to change sanctioned use of building shall be made by the owner, for which a change in use is proposed and the Persons on Record, in the format prescribed in Form No. 25 Drawings, specifications, and documents to be submitted along with the application shall be as is specified in Schedule No. 6C.

6.6.2 Fees

All fees and charges for obtaining Permission to Change Sanctioned Use of Building are listed in Schedule No. 5A.

The fees and charges shall be determined by the Competent Authority from time to time.

6.6.3 Scrutiny of Application, Grant, Refusal

- 1 The Competent Authority shall undertake scrutiny of the Application for Permit to Change Sanctioned Occupancy of Development and communicate to the applicant the date and time for plot inspection, if required, using Form No. 20 within 15 working days of the date of acceptance of the application.
- 2 Lack of compliance with Rules and/or queries pertaining to the application shall be communicated in the format prescribed in Form No. 21 within 21 working days of the date of acceptance of the application.
- 3 Acceptance or rejection of compliant modifications in the application and responses to queries shall be communicated in the format prescribed in Form No. 22A or Form No. 22B within 10 working days of receipt of the modifications and responses. Acceptance or rejection of further compliant modifications in the application and responses to queries shall also be.
- 4 A Permit to Change Sanctioned Occupancy of Development, in the format prescribed in Form No. 25 shall be issued to the applicant when the Competent Authority is satisfied that the proposed change of Occupancy of the development complies with these Rules. Reasons for rejection of application shall be communicated in the format prescribed in Form No. 25.

6.6.4 Penalties

Any development undertaken shall be in conformity of these Rules. Financial penalty, for different conditions of occupancy, shall be levied as prescribed in Schedule No. 5D for unauthorised use of development.

For making unauthorised use of a building, penalty equal to, four times the development permission scrutiny fees that is leviable for the built-up area of the building entities used unauthorised.

Provided that the scrutiny fee calculated in reference to above shall be to the extent of excess area or for the area which may be considered unauthorised.

Part B Planning Rules

Part B Planning Rules

7 General Planning and Development Rules

- 7.1 Use Zone Classification and Permissible Uses
- 7.2 Permissible uses with respect to Road Width
- 7.3 Floor Space Index
 - 7.3.1 Floor Space Index (FSI) for Different Use Zones
 - 7.3.2 Area Exempted from Computation of Floor Space Index (FSI)
 - 7.3.3 Transfer of Development Rights (TDR)
- 7.4 Minimum Area of Building Unit for Different Uses
- 7.5 Approach Road / Access to Building Unit
 - 7.5.1 Approach Road / Means of Access.
 - 7.5.2 Land Locked Building Unit and Required Road Width
- 7.6 Building Height
- 7.7 Margins
 - 7.7.1 Roadside Margin or Front Margin
 - 7.7.2 Rear and Other Side Margins
 - 7.7.3 Margins between Buildings and Common Plot
 - 7.7.4 Permissible Uses in Margin
 - 7.7.5 Restrictions on Development in Margin
- 7.8 Basement in a Building Unit
 - 7.8.1 Margin
 - 7.8.2 Extent
 - 7.8.3 Height
 - 7.8.4 Permissible uses
 - 7.8.5 Services
 - 7.8.6 Basement (Core Area and Gamtal/Gaothan)
- 7.9 Addition to an Existing Structure / Building
- 7.10 Addition in Building Unit with Existing Building
- 7.11 Row House and Tenement Type Buildings
 - 7.11.1 Row Type Buildings
 - 7.11.2 Tenement Type Building
- 7.12 Provision for Podium
 - 7.12.1 Uses Permitted
 - 7.12.2 General Requirements
 - 7.12.3 Requirements for the Fire Tender Movement
- 7.13 Parking
- 7.14 Open to Sky Space
 - 7.14.1 Dimensions of Open Space
 - 7.14.2 Open next to WC and Bathroom
 - 7.14.3 General Requirements
- 7.15 Development of Land
 - 7.15.1 Internal Road and Approach to Building and Common Plot
 - 7.15.2 General Requirements for Internal Roads
 - 7.15.3 Amalgamation and Subdivision of Building-Unit
 - 7.15.4 Contribution of Land for any Development in Non-Town Planning Scheme Areas
 - 7.15.5 Common Plot
- 7.16 Development on Kabrastan, Burial Ground etc
- 7.17 Development on Open Space Plots
- 7.18 Heritage / Architectural Significant Areas
- 7.19 Discrepancy Removal
- 7.20 Development Work to be Conformity with the Rules

8 Affordable Housing and SPARSH 2.0 Housing

- 8.1 Affordable Housing – Group
 - 8.1.1 Applicability
 - 8.1.2 Minimum Sizes and Accommodation Requirements
 - 8.1.3 Density and Floor Space Index
 - 8.1.4 Common Plot
 - 8.1.5 Parking
- 8.2 Affordable Housing – Plotted
 - 8.2.1 Applicability
 - 8.2.2 Minimum Sizes and Accommodation Requirements
 - 8.2.3 Density
 - 8.2.4 Common Plot
 - 8.2.5 General Building Requirements
 - 8.2.6 Structural Requirements
- 8.3 SPARSH 2.0 Housing
 - 8.3.1 Applicability
 - 8.3.2 Minimum Required Accommodation
 - 8.3.3 Floor Space Index
 - 8.3.4 Margins
 - 8.3.5 Common Plot
 - 8.3.6 Parking

9 Mining, Quarrying and Brick Kiln

10 Fuelling Station

- 10.1 Location
- 10.2 Maximum Permissible Ground Coverage
- 10.3 Margins
 - 10.3.1 For Fuelling Station without Service Station
 - 10.3.2 For Fuelling Station with Service Station
- 10.4 Height, Floor Space Index and Common Plot
- 10.5 Parking
- 10.6 Basement

11 Electric Vehicle (eV) Charging Station

12 Advertising Display and Communication Infrastructure

- 12.1 Outdoor Advertising Display Infrastructure
 - 12.1.1 Billboards / Hoarding in Margin Space
 - 12.1.2 Billboards / Hoardings on Roof tops / Terrace
 - 12.1.3 Billboards / Hoarding on Public Roads
 - 12.1.4 Billboards in Urban Renewal Project Areas
 - 12.1.5 Heritage Buildings and Precincts
 - 12.1.6 General Restrictions
- 12.2 Communication Infrastructure Telecommunication infrastructure/ microwave communication tower

Table

Table No. 7.1	Protection of Building Structures and Infrastructure in Hazard Prone Areas
Table No. 7.2	Classification of Land Use Zones and Permissible Uses in Outline Development Plan (Daman District)
Table No. 7.3	Uses Permitted in Each Category.
Table No. 7.4	Permissible Uses as Per Road Width, Daman District
Table No. 7.5	Land Use Zone and FSI for Daman District
Table No. 7.6	Transfer of Development Rights for the Respective Zone, Daman District
Table No. 7.7	Use and Minimum Building Unit Size Requirement
Table No. 7.8	Minimum Plot size for Subdivision/ Layout
Table No. 7.9	Road Widths in Outline Development Plan
Table No. 7.10	Roadside Margin (Non-Core Area and Gamtal / Gaothan) Except Industrial Use
Table No. 7.11	Roadside Margin (Core Area and Gamtal / Gaothan)
Table No. 7.12	Roadside Margin (For Industrial)
Table No. 7.13	Rear and Side Margins
Table No. 7.14	Margin between Two Buildings and Margin from Common Plot
Table No. 7.15	Width of Internal Road based on the Length of Road
Table No. 7.16	Width of Ramp for Vehicle
Table No. 7.17	Parking Requirements
Table No. 7.18	Minimum Width of Open to Sky in Outside Core Area and Gamtal / Gaothan
Table No. 7.19	Provisions for the Length of Road Layout, Sub Plotting and Building Approach
Table No. 7.20	Radius of Road Curvature Based on Width of the Road
Table No. 7.21	Minimum Side of Building Unit
Table No. 7.22	Minimum Common Plot Requirements
Table No. 8.1	Chargeable FSI for Affordable Housing Dwelling
Table No. 8.2	Parking Norms for Affordable Housing
Table No. 8.3	Plot Area and Minimum Margins
Table No. 10.1	Minimum Parking for Fuelling Station
Table No. 12.1	Billboards/ Hoardings in Margin Space
Table No. 12.2	Billboards/ Hoarding on Roof Tops / Terrace
Table No. 12.3	Billboards / Hoarding on Public Roads

Figure

Figure No. 7.1	Staircase, Sky Walks and Stair Cabin / Mumty
Figure No. 7.2	Building Unit Abuts the Existing Road
Figure No. 7.3	Land Locked Building Unit
Figure No. 7.4	Roadside Margin / Front Margin
Figure No. 7.5	Margin to be Used for Electric Infrastructure
Figure No. 7.6	Details of Permissible Parking
Figure No. 7.7	Basement or Cellar
Figure No. 7.8	Height of the Basement
Figure No. 7.9	Building on Podium
Figure No. 7.10	Ramp on Podium
Figure No. 7.11	Emergency Vehicle Access Requirements in Case Podium is Not Accessible by Fire Tender.
Figure No. 7.12	Open-to- Sky Space (Gamtal / Gaothan)
Figure No. 7.13	Internal Road and Approach to Building and Common Plot
Figure No. 7.14	Amalgamation and Subdivision of Building - Unit.
Figure No. 7.15	Common Plot
Figure No. 10.1	Minimum Distance from the Junction.
Figure No. 10.2	Minimum Margin for Fuelling Station without Service Station
Figure No. 10.3	Minimum Margin for Fuelling Station with Service Station

7 General Planning and Development Rules

7.1 Use Zone Classification and Permissible Uses

In the Outline Development Plan, different use zones with the permissible uses are shown in Table No. 7.2 below.

In addition, the following conditions shall apply:

- 1 No development shall be permitted in area designated for water bodies and water courses (river, natural drains, canal, nala, kotar, ponds, lakes and talavs) shown in the Outline Development Plan. Margins to be maintained from a designated water body shall be as prescribed in these Rules.
- 2 In any land designated under any legislation, for public purpose, the uses shall be permissible as per the requirements of these Rules.
- 3 The land/plot allotted to any Government or Government Autonomous body like Municipality, District Panchayat, Planning and Development Authority, or a Government Company under Town Planning Scheme for public purpose shall be utilized for uses under 'Public Purpose' as per the applicable zones or road widths prescribed in these Rules subject to suspension of any provision of these Rules by the Government under Section 64 of the Act.
- 4 Every development shall have to conform with the presently recommended land use except in the following cases:
 - a) The existing buildings constructed as per previously recommended land use shall be allowed to be repaired or retrofitted.
 - b) The old use shall be permitted only until the useful life of the building.
 - c) Any new building on a plot with partial built up as per previous Rules / Outline Development Plan, shall be permitted only when it conforms with the presently recommended land use in presently earmarked zone. However, any new construction shall have to comply with existing CRZ, Coast Guard, ASI regulations etc.
- 5 For all zones, if the line of a zone divides a building unit, the right of the plot holder to the FSI shall be determined as per following principles.
 - a) For plots whose part comes under CRZ, Coast Guard, or ASI the owner/developer may either treat his plot as constituted of two separate plots and construct two buildings consuming the FSI available on these hypothetical parts—calculated on the basis of area of these supposed parts, or he may consume higher FSI available calculated on the basis of area of entire plot subject to condition that he shall be allowed construction only on the part of the plot where higher FSI is available.
 - b) If in such cases the Developer goes with First option, the use of each building unit shall be regulated as per respective zones.
In both cases, other development restrictions shall be applicable.
 - c) For cases, where 50% or more plot falls in the higher FSI zone then the developer shall be allowed higher of the two FSIs available. If less than 50% of the plot falls in higher of the two FSI zones, then then the maximum permissible built up shall be based on the FSI of the respective zone.
For contiguous development, the maximum permissible built-up area in the building unit shall be based on FSI of respective zone.
- 6 Utility structures shall be permitted in any zone except Preservation Zones but shall be subject to all applicable Rules and Regulations for the time being in force.
- 7 Permissible use of a building shall be determined by the zone, the plot area and the abutting road width of the building unit.
- 8 For Eco-Sensitive Zone / Area shall also confirm the notification published by the “Ministry of Environment and Forest”, Notification no. S.O.1067, dated, 14th September 2006” and amended from time to time.
- 9 Any mixed-use building having industry as one of the uses, shall only be allowed in industrial zone. Residential and Industrial use shall not be allowed in the same building.
- 10 Land Use Zoning in Hazard Prone Areas

In natural hazard prone areas namely the earthquake prone zones as per IS:1893, the cyclone prone areas as per IS:875 Part – 3 and flood prone areas as per the Flood Atlas prepared by the Central Water Commission and/or the flood departments of the Government, the development shall be regulated to ensure special protection from hazards for any type of development irrespective of use zone. Whereas the hazard prone areas identified as per the Vulnerability Atlas of India, 1997 (hereinafter referred as Atlas) (or revisions thereof) prepared by Government of India or as may be prepared by Government from time to time shall be used for such regulations, as given in Appendix B of the Atlas. Further action for protection from these hazards is to be dealt with taking into consideration the guidelines given in Table No. 7.1 hereunder:

Table No.7.1: Protection of Buildings Structures and Infrastructures in Hazard Prone Areas

<p>A Protection of Areas from Earthquakes</p> <p>(i) In those areas where there are no dangers of soil liquefaction or settlements or landslides, all building structures and infrastructures should be designed using the relevant Indian Standards as provided in the Building Regulations and the National Building Code</p> <p>(ii) Soils subjected to liquefaction potential under earthquake shaking, can be improved by compaction to desired relative densities, so as to prevent the possibility of liquefaction.</p> <p>(iii) Buildings and structures could be founded on deep bearing piles going to non- liquefiable dense layers.</p> <p>(iv) Steep slopes can be made more stable by terracing and construction of retaining walls and breast walls, and by ensuring good drainage of water so that the saturation of the hill-slope is avoided.</p> <p>(v) Any other appropriate engineering intervention to save the building structures or infrastructure from the fury of the earthquake.</p> <p>Note: The protective action given under (ii) to (v) in this table, will usually involve large amount of costs and should only be considered in the case of large and costly structures. For ordinary buildings the cost of improvement of the site will usually be uneconomical, hence bad sites should be excluded by Land Use Zoning.</p> <p>B Protection from Cyclonic Wind Damage</p> <p>i) Buildings, structures, and infrastructures in the cyclone prone areas should be designed according to the Indian Standards and Guidelines as provided in the Regulations and the latest National Building Code.</p> <p>ii) Light utility structures used for electrical transmission and distribution, and towers for communications, chimneystacks of industrial structures require special design considerations against the cyclonic wind pressures, suction, and uplifts.</p> <p>iii) In case the buildings, structures and infrastructures are founded on marine clay deposits it will be advisable to adopt either under-reamed piled foundations, or individual column footing with a reinforced concrete beam located at the level of the ground, or a continuous reinforced concrete strip footing.</p> <p>iv) Wherever, the topsoil could become slushy due to flooding, the top layer of 30 cm depth of soil should not be considered for providing lateral stability.</p> <p>v) In storm surge prone areas, it will be preferable to construct the community structures, like schools, cyclone shelters, etc. by raising the level of the ground protected by provision of retaining walls at sufficient distance away from the building, taken to such depth that no erosion takes place due to receding storm surge. Alternatively, construct the community structures on stilts with no masonry or bracing up to the probable maximum surge level.</p> <p>C Protection of Areas from Floods</p> <p>This may require one or more of the following actions:</p> <p>i) Construction of embankments against the water spills from the source of flooding like rivers, large drain etc.</p> <p>ii) Construction of high enough embankments / bunds around the planning area.</p> <p>iii) Raising the planning area above the high flood level.</p> <p>iv) Construction / improvement of drainage paths to effectively drain the water from the planning area.</p> <p>v) Construction of buildings and structures on deep foundations going below the depth of scour or on stilts with deep enough foundations underwater.</p>
--

- vi) Flood proofing works such as the following:
- vii) Providing quick drainage facility, consisting of
 - a) Revitalisation of secondary and primary drainage channels after establishing the drainage blockage points.
 - b) Provision of additional waterways.
 - c) Clearing of clogged cross drainage works.
- viii) Providing human and animal Shelters for population living within embankments in the form of raised platform or use of available high ground.
- ix) Anti-erosion actions in affected areas.
- x) Any other suitable measure.

Notes:

- 1 Similar protection methods could be used against flooding caused in cyclone prone areas by high intensity rains or by the storm surge.
- 2 The concept of land zoning should be kept in mind for areas where protection works are taken up to decide inter-se priority for location of structures considering possibility of failure of protection works during extreme disaster events.

- 15 For Railway Container Depot the permission shall be issued for development of structures of the Railway Department.
- 16 Permissible uses as mentioned in Table No. 7.2 are broad indicators of the type of use permissible in each zone. In case any dispute arises whether or not an activity falls within the permissible use of a zone, concerned Planning and Development Authority shall be the Competent Authority to decide such issue.
- 17 In case of mixed-use buildings with residential and permissible non-residential uses, either on the ground floor or any other floors, they shall be provided with separate means of access / staircase.

Table No. 7.2: Classification of Land Use Zones and Permissible Uses in Outline Development Plan (Daman District)

No.	Zones	Conceptualized Zone	Code	Permissible Use referred as code (Code detailed in Table No. 7.3)
(1)	(2)	(3)	(4)	(5)
1	Preservation Zone-I (CRZ IA and IB)*	Preservation Zone	PZ-I	EP1, EP2 All activities as per CRZ
2	Preservation Zone-II (CRZ IA)	Preservation Zone	PZ-II	EP1, EP2, REC1, TEMP (Except Concrete batching plant)
3	Recreational Zone-I	Light Intensity Recreational Zone	RZ-I	EP1, REC1, TEMP (Except Concrete batching plant)
4	Recreational Zone-IB (CRZ IB)	As per CRZ-2019	RZ-IB	Permissible activities as per CRZ-2019
5	Recreational Zone-IC (CRZ III- NDZ)	As per CRZ-2019	RZ-IC	Permissible activities as per CRZ-2019
6	Recreational Zone-ID (CRZ III- Beyond NDZ)	As per CRZ-2019	RZ-ID	Permissible activities as per CRZ-2019
7	Recreational Zone-II	Medium & High Intensity Recreational Zone	RZ-II	EP1, EP2, REC1, REC2, TEMP, SP&L, REG, HO1, HO2, HO3, CBG, M1, EDU1, EDU2, AS1, AS2, AS3, AS4, H1, H2, PO, U, DW1, DW2, AG1 DW1a, DW2a

No.	Zones	Conceptualized Zone	Code	Permissible Use referred as code (Code detailed in Table No. 7.3)
(1)	(2)	(3)	(4)	(5)
8	Recreational Zone -IIA (CRZ I-A)	As per CRZ-2019	RZ - IIA	Permissible activities as per CRZ-2019
9	Recreational Zone IIC (CRZ III- NDZ)	As per CRZ-2019	RZ-II C	Permissible activities as per CRZ-2019
10	Recreational Zone -IID (CRZ III- Beyond NDZ)	As per CRZ-2019	RZ- IID	Permissible activities as per CRZ-2019
11	Core Area & Gaothan	Existing Old Settlements	CAG	DW1, DW2, DW3, M1, M2, EDU1, EDU2, AS1, AS2, REG, REC1, HO1, HO2, SE1, HO3, SP&L, H1, H2, TEMP, PO, U, CBG, EP1, EP2, DW1a, DW2a
12	Core Area and Gaothan -A (CRZ IA)	As per CRZ-2019	CAG- A	Permissible activities as per CRZ-2019
13	Industrial Zone- I	Light & Medium Intensity Industrial Zone	IZ-I	DW1, DW2, DW3a, DW3s, DW1a, DW2a, H1, H2, H3, M1, M2, M3, EDU1, EDU2, EDU3, AS1, AS2, AS3, IN1, IN2, IN3, CBG, AG1, AG2, PO, U, TR, REG, ST, HO3, SE1, SE2, TEMP, REC1, ST
14	Industrial Zone- IC (CRZ III- NDZ)	As per CRZ-2019	IZ1- IC	Permissible activities as per CRZ-2019
15	Industrial Zone- II	High Intensity Industrial Zone	IZ-II	DW1, DW2, DW3a, DW3s, DW1a, DW2a, M1, M2, M3, EDU1, EDU2, EDU3, IN1, IN2, CBG, AS1, AS2, AS3, ST, H1, H2, H3, H4, PO, U, TR, REG, HO3, SE1, SE2, ST, TEMP, REC1, AG1
16	Development Zone -I	Light & Medium Intensity Development Zone	DZ-I	DW1, DW2, DW3, DW3a, DW3s, DW1a, DW2a, M1, M2, M3, EDU1, EDU2, EDU3, AS1, AS2, AS3, AS4, REG, HO1, HO2, HO3, REC1, REC2, SP&L, H1, H2, H3, H4, SE1, ST, TR (Except Goods Terminal), CBG, AG1, PO, U, TEMP, EP1, EP2
17	Development Zone- IB (CRZ IB)	As per CRZ-2019	DZ- IB	Permissible activities as per CRZ-2019
18	Development Zone -IC (CRZ III- NDZ)	As per CRZ-2019	DZ- IC	Permissible activities as per CRZ-2019
19	Development Zone -ID (CRZ III- Beyond NDZ)	As per CRZ-2019	DZ- ID	Permissible activities as per CRZ-2019
20	Development Zone -II	High Intensity Development Zone	DZ-II	DW1, DW2, DW3, DW3a, DW3s, DW1a, DW2a, M1, M2, M3, EDU1, EDU2, EDU3, AS1, AS2, AS3, AS4, REG, HO1, HO2, HO3, SE1, ST, TR (Except Goods Terminal), CBG, AG1 (Except Poultry Farming), PO, U, REC1, REC2, SP&L, H1, H2, H3, H4, TEMP, EP1, EP2
21	Development Zone- IIC (CRZ III- NDZ)	As per CRZ-2019	DZ- IIC	Permissible activities as per CRZ-2019

No.	Zones	Conceptualized Zone	Code	Permissible Use referred as code (Code detailed in Table No. 7.3)
(1)	(2)	(3)	(4)	(5)
22	Development Zone -IID (CRZ III- Beyond NDZ)	As per CRZ-2019	DZ-IID	Permissible activities as per CRZ-2019
23	Airport- No Development Zone	As per CCZM	A-NDZ	Uses permitted as per Coast Guard

Notes:

Also refer Table No. 7.4 for road width provisions for some of the Uses.

*Preservation Zone 1 is covering more area than the notified CRZ IA & IB as per the existing mangroves and mudflats and it also includes green area along natural drains (kotar).

Table No. 7.3: Uses Permitted in Each Category

No.	Use		Uses
	Classification	Code	
(1)	(2)		(3)
1	Dwelling 1	DW1	Detached dwelling unit. Clinic not having indoor treatment facility. Farmhouse <i>Part of Residential building may be used for professional requirements for office by advocated, doctors, architects, engineers & chartered accountants, and home occupation</i>
2	Dwelling 1a	DW1a	Detached dwelling unit – affordable Housing
3	Dwelling 2	DW2	Semi-detached dwelling unit Row House Tenement Farmhouse Clinic not having indoor treatment facility, Cottage Industry (not involving use or installation of any kind which may create noise, vibration, fume dust etc.), Pre-school <i>Part of Residential building may be used for professional requirements for office by advocated, doctors, architects, engineers & chartered accountants, and home occupation</i>
4	Dwelling 2a	DW2a	Semi Detached dwelling unit – affordable Housing
5	Dwelling 3	DW3	Flats / Apartment (including mixed use apartments, Serviced Apartments) Hostel Dharamshala Home stay Old Age Home Orphanage Night Shelter
6	Dwelling 3a Dwelling 3s	DW3a, DW3s	Affordable Housing Chawls Labour Housing Sparsh Housing / Affordable Housing / Affordable Rental Housing Complex / Low-Cost Housing Complexes
7	Mercantile 1	M1	Retail shop Shopping Centre Office Restaurant Café Light Home Workshop LPG Cylinder Godown Fitness Centre / Gymnasiums Bank

No.	Use		Uses
	Classification	Code	
(1)	(2)		(3)
			Fuel stations (with and without service station)
8	Mercantile 2	M2	Shopping Mall/Complex Business / Corporate offices Laboratory Training Centres Cineplex (having maximum seating capacity of 40 seats), Vegetable/Fish Market/ Agriculture/ Horticulture Produce
9	Mercantile 3	M3	Wholesale Market and ancillary uses Timber mart / Lathi Bazaar Kerosene Depot
10	Education 1	EDU1	Anganwadi / Day Care / Pre School Pre-Primary School
11	Education 2	EDU2	Primary Schools Secondary Schools Higher Secondary Schools
12	Education 3	EDU3	Polytechnic Industrial Training Institutes (ITI) / Vocational Training Centre College University and ancillary use Research and Development Establishment / Centres
13	Assembly 1	AS1	Community Hall Banquet Hall Library
14	Assembly 2	AS2	Town Hall Convention Centre Exhibition Hall Auditorium Planetarium Museum Stadium Studio Performing Arts Theatre Gymnasium Library Club
15	Assembly 3	AS3	Theatre Cinema Multiplex Club
16	Assembly 4	AS4	Party Plot Garden Restaurants Drive-in Cinema Golf Course
17	Religious	REG	Temple Shrine Church / Chapel Mosque / Dargah Gurudwara Synagogue Ashram / Upashraya / Math / Sant Niwas Any other Religious Structure.
18	Hospitality 1	HO1	Camping Tents Eco Hotels
19	Hospitality 2	HO2	Resort Cottage Houses Spa and Wellness Centre
20	Hospitality 3	HO3	Bed and Breakfast

No.	Use		Uses
	Classification	Code	
(1)	(2)		(3)
			Guest House Lodging and Boarding Hotel / Motel Serviced Apartment
21	Service Establishment 1	SE1	Auto Repair Workshop Wood Workshop Fabrication workshop Service Garage Repair and Sale of agricultural equipment Flour mills Laundry / dry cleaning establishment
22	Service Establishment 2	SE2	Call Centres and other service-related shops Information Technology (IT) Biotechnology (BT) Nano Technology (NT)
23	Industrial 1	IN1	All White Category of Industries as defined by CPCB in Classification of Industrial Sector (2016)
24	Industrial 2	IN2	All Green Category of Industries as defined by CPCB in Classification of Industrial Sector (2016), CETP
25	Industrial-3	IN3	All Orange Category of Industries as defined by CPCB in Classification of Industrial Sector (2016), CETP Dumping of Solid Waste Mining and Quarrying Brick Kiln Roof Tiles Tannery Slaughterhouse Petroleum Storage Roofing Tiles and Cement Pipes
26	Storage	ST	Warehouse Godown Cold Storage Steel Stockyard Ice factory
27	Transport	TR	Bus Terminal / station (public / private) Transport Terminal for Goods (Truck) Transport Terminal for Passengers
28	Cremation and Burial	CBG	Crematorium Cemetery Burial Ground / Kabrastan
29	Agriculture 1	AG1	Horticulture/ Orchard Green Houses Dairy Development Farmhouse Apiculture Organic farming Animal rearing and breeding / gaushala / panjrapole Golf Course, Poultry Farm
30	Agriculture 2	AG2	Repair and Sale of agriculture equipment Sawmill Brick Kiln Fisheries & Ancillary Activities Cemetery & Burial Ground Way-side shop Animal Shed Agro-Based Storage

No.	Use		Uses
	Classification	Code	
(1)	(2)		(3)
31	Temporary Use	TEMP	Fair Circus Exhibition Mela Pandal Concrete Batching Plant for Construction Temporary Seasonal Market Portable Public toilets
32	Utility	U	Bus Stop/Station Fuelling and eV Station and Storage with and without Service Station Taxies/ Scooter/Cycle Stands Parking / Multi-level Parking Infrastructure for Water Supply – treatment / purification Plant, pumping station. Communication Infrastructure – telephone, microwave tower or other means of communication facilities, Post & Telegraph Electricity Sub-station Drainage, Sanitation Domestic Garbage Disposal Collection / Solid Waste Transfer Station Fire Station Solar Power Plant Public Urinals or any development activity carried out by appropriate authority for public purpose
33	Public / Public Office	PO	Offices for public / government / semi government entities for Health, transport, communication, security, ward office, law courts, police stations / chowkis, panchayat, circuit house etc. Custodial and Penal institutions such as jails, prison, mental hospitals, houses of correction, detention and reformatories
34	Health 1	H1	PHC, Clinic (with & without indoor facilities), Dispensary Health and Wellness Centre /Ayushman Bharat
35	Health 2	H2	Indoor Hospital facility up to 20 Bed Surgical Hospital, Nursing Home, Maternity Home Community Health Centre Veterinary Facilities
36	Health 3	H3	Multi-specialty hospital- Upto 100 beds Medical College and Research Centre Hospital – More than 100 Beds
37	Health 4	H4	Hospital for infectious diseases Mental Hospital / Asylum
38	Recreation 1	REC1	Camping Ground Picnic spots, Open Seating Areas Kiosk Gardens / Parks / Theme Gardens Nursery Play Fields
39	Recreation 2	REC2	Natural Reserve and Sanctuary Racetrack Shooting Range Zoo Botanical Garden Regional Parks Green House Forest / plantation

No.	Use		Uses
	Classification	Code	
(1)	(2)		(3)
40	Sports and Leisure	SP&L	Gymnasium Sports complex Swimming pool Playfield Water sports facilities Theme / Amusement Park Aquarium Botanical Garden Exhibition and Mela Shooting Range
41	Environmental Preservation 1	EP1	Check dams. Structures to prevent landslides and erosion. Developments to preserve/conserve/enhance natural scenery, landscape, and environmental features. Natural Reserves and Sanctuary
42	Environmental Preservation 2	EP2	Pedestrian trail and board walk Fisheries related activities – natural fish drying, hatchery, aqua culture, fish processing. Jetties Wharves/ Quays/ Slipway Port Harbour Hover ports for Coast Guards Tidal Regulators Water Treatment Facilities, Non-Conventional Power Desalination Plant Ocean and Water Monitoring Platforms (Activities under CRZ 1A and 1B)
43	Environmental Preservation 3 (Eco Sensitive Zone around Wildlife Sanctuary)	EP3	All regulated and promoted activities in Eco-sensitive Zone around Wildlife Sanctuary defined by “Ministry of Environment, Forest and Climate Change Notification (2015)” which includes: <u>Regulated Activities</u> Felling of trees Commercial use of water resource including ground water harvesting Discharge of treated effluents Erection of electrical cables and telecommunication towers Widening of roads and strengthening of existing roads and construction of new roads Movement of vehicular traffic at night. Introduction of exotic species. Fencing of premises of hotels and Lodges Commercial Signboards and Hoardings Small scale industries not causing pollution. Laying of gas pipelines <u>Promoted Activities</u> Rainwater harvesting Organic farming Cottage industries including village industries, convenience stores and local amenities. Use of renewable energy sources

7.2 Permissible Uses with respect to Road Width

- 1 Uses on a building unit shall be regulated on the basis of road width as mentioned in Table No. 7.4.
- 2 Public utility structures shall not be regulated based on road width.

Table No. 7.4: Permissible Uses as Per Road Width, Daman District

No.	Road Width	Building Uses Permissible		Restrictions
		Core Area (CA) & Gamtal / Gaothan (GM)	Other than Core Area (CA) & Gamtal / Gaothan (GM)	
(1)	(2)	(3)	(4)	(5)
1	less than 9 m	DW1, DW1a, DW2, DW2a, DW3, H1	DW1, DW1a, DW2, DW2a, H1	DW3 (not more than 4 floors including stilt)
2	9 m and less than 12 m	All permitted in Sr. No. 1 above and M1, EDU1, DW3	All permitted in Sr. No. 1 above and EDU1, REG, M1 & DW3	M1 on Ground floor only DW3 (not more than 4 floors including stilt)
3	12 m and less than 15 m	All permitted in Sr. No. 2 above and M1, M2, HO1, HO2, HO3, SE1, REC1, REG, PO, H2, DW3	All permitted in Sr. No. 2 above and M1, AS1, H2, M2, EDU2, H3, PO, U, TEMP, HO1, HO2, HO3, REC1, REC2, AG1, AG2, DW3, SE1, CBG and I1, I2, I3	M1, M2 and SE1 on Ground and first floor only. DW3 (not more than 4 floors including stilt) I1, I2, I3 – Plot Size > 800 & ≤ 2000
4	15m and less than 18 m	All permitted in Sr. No. 3 above and U, H2, DW3, DW3a, DW3s	All permitted in Sr. No. 3 above and I1, I2, I3, SE2, DW3, DW3a, DW3s,	I1, I2, I3 – Plot Size > 2000 & ≤ 5000
5	18 m and less than 25 m	All permitted in Sr. No. 4 above and DW3, M1, M2, AS1, H3, EDU2	All permitted in Sr. No. 4 above and DW3, REG, EDU3, AS2, AS3, AS4, H4, ST, SP&L, M3, EP1, EP2, EP3	All floors
6	25 m and more	All permitted in Sr. No. 5 above and EDU3, REC2, TEMP, AG1, AG2, CBG, M3, AS2, AS3, AS4, SE2, H4, SP&L, EP1, EP2, EP3	All permitted in Sr. No. 5 TR	All Floors

7.3 Floor Space Index (FSI)

7.3.1 Floor Space Index (FSI) for Different Use Zones

- a) The maximum permissible FSI, the chargeable FSI and TDR FSI on a building unit for land use zones shall be regulated as per Table No. 7.5.
- b) In case of Affordable Housing- Group the rates for chargeable FSI are indicated in Rule 8.1.3
- c) In case of SPARSH Housing the FSI is indicated in Rule 8.3.3
- d) Whenever CRZ implications are present in Preservation Zones I and II, the more stringent of the permissible activities as per CRZ will prevail.

Table No. 7.5: Land Use Zones and FSI for Daman District

No.	Use Zone	Code	Permissible Base FSI	FSI Chargeable (at 100% of Circle Rate)	TDR FSI	FSI Maximum Permissible
(1)	(2)	(3)	(4)	(5)	(6)	(7)
1	Preservation -Zone I (CRZ IA and IB)	PZ-I	Nil	Nil	Nil	Nil
2	Preservation -Zone II (CRZ IA)	PZ-II	Nil	Nil	Nil	Nil
3	Recreational Zone- I	RZ-I	0.15	0	0	0.15
4	Recreational Zone -IB (CRZ IB)	RZ-IB	Nil	Nil	Nil	Nil
5	Recreational Zone -IC (CRZ III- NDZ)	RZ-IC	Nil*	Nil	Nil	Nil
6	Recreational Zone -ID (CRZ III- Beyond NDZ)	RZ- ID	0.33	0	0	0.33
7	Recreational Zone -II	RZ-II	0.50	0.25	0.25	1.00
8	Recreational Zone -IIA (CRZ IA)	RZ-II A	Nil	Nil	Nil	Nil
9	Recreational Zone -IIC (CRZ III- NDZ)	RZ-II C	Nil*	Nil	Nil	Nil
10	Recreational Zone- IID (CRZ III- Beyond NDZ)	RZ- IID	0.33	0	0	0.33
11	Core Area & Gaothan	CAG	1.50	0	0	1.50
12	Core Area and Gaothan -A (CRZ IA)	CAG- A	Nil	Nil	Nil	Nil
13	Industrial Zone -I	IZ-I	1.75	0.35	0.15	2.25
14	Industrial Zone -IC (CRZ III- NDZ)	IZ1-IC	Nil*	Nil	Nil	Nil
15	Industrial Zone- II	IZ-II	2.00	0.50	0.25	2.75
16	Development Zone -I	DZ-I	2.00	0.30	0.20	2.50
17	Development Zone -IB (CRZ IB)	DZ-IB	Nil	Nil	Nil	Nil
18	Development Zone -IC (CRZ III- NDZ)	DZ-IC	Nil*	Nil	Nil	Nil
19	Development Zone -ID (CRZ III- Beyond NDZ)	DZ-ID	0.33	0	0	0.33
20	Development Zone -II	DZ-II	2.00	1.00	0.50	3.50
21	Development Zone - IIC (CRZ III- NDZ)	DZ-IIC	Nil*	Nil	Nil	Nil
22	Development Zone - IID (CRZ III- Beyond NDZ)	DZ- IID	0.33	0	0	0.33
23	Airport- No Development Zone	A- NDZ	Nil	Nil	Nil	Nil

Note:

*Activities as per the CRZ- NDZ regulations

- 1 Preservation zone 1 is covering more area than the notified CRZ IA & IB as per the existing mangroves and mudflats and it also includes green area along natural drains (kotar).
- 2 TDR FSI
FSI is Nil for the zones that are formed due to overlay of CRZ zones and CCZ zone on base zones.
These zones are not provided with any FSI under the provision of the Outline Development Plan, however, if there is any existing development it will be allowed to continue provided it complies with the respective notification of CRZ and CCZ prevailing at that

time. Development in all such zones will be subject to the permission of the respective authorities in compliance with the relevant act.

Zones where the FSI is Nil due to implication of CRZ, TDR may be issued by Competent Authority considering a notional FSI of 1 subject to surrendering of land to Competent Authority who then may develop these as urban greens. The TDR can be used in zones indicated in table above.

Zones where the maximum permissible FSI is 0.33 due to implication of CRZ, TDR may be issued by Competent Authority considering a base FSI of 1 subject to surrendering of land to Competent Authority.

7.3.2 Area Exempted from Computation of Floor Space Index (FSI)

The following areas shall not be counted towards calculation of FSI:

- 1 All interior open to sky spaces such as courtyards and chowk, utility ducts in any form, shape and size required by these Rules.
- 2 Area used for parking at basement or hollow plinth or parking at any level provided. However, if more than 25% of any such level is used for any purposes other than parking, then the whole level shall be calculated towards FSI. Any area, which is less than 25% of the total built up area of a floor, which is being used for purposes other than parking shall be counted towards calculation of FSI.
- 3 Hollow plinth – uses such as room for telephone distribution board, common toilet for both the genders, water room, servant room, and security cabin and entrance foyer etc are permitted up to 25 sq m in, which shall not be considered towards computation of FSI. An electric meter room up to 50 sq m is permitted and its area is not considered towards computation of FSI.
- 4 Loft up to a maximum of 30% of the enclosed space.
- 5 Staircase, sky walks intermediate landing and stair cabin / mumty subject to following conditions:
 - a) Only Maximum landing width at floor level shall be two times the width of stair (x m) including additional space (0.5 x m) provided at either side of the stair landing as common area shall be exempted (*Refer Figure No. 7.1*).

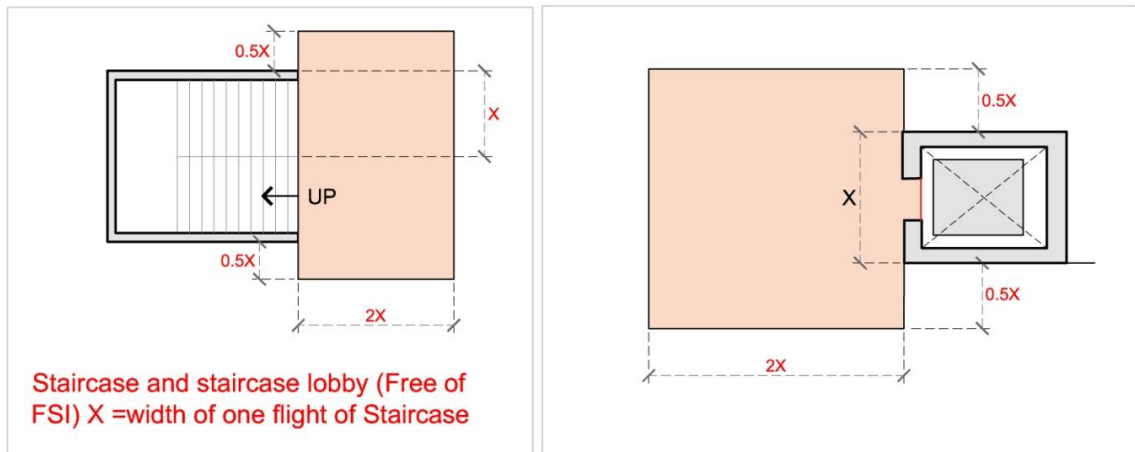

Figure No. 7.1: Staircase, Sky Walks and Stair Cabin/ Mumty

- 6 Lift, lift well with lift cabin, lift landing of lift well and water tank, including walls provided as per Rule No. 13.1.12 with the following conditions:
 - a) The width of the lift landing shall be considered equal to the maximum width of the lift well including walls (x m) with an additional space (0.5 x m) at either side of the lift provided as common area as illustrated across.
 - b) The depth of the lift landing shall be two times the maximum width of the lift well including walls (x m) as illustrated in Figure No. 7.1.
- 7 Vehicular ramps and pedestrian ramps.
- 8 Electric room, electric substation, transformer room, box-type transformer, section feeder pillar, auxiliary power back-up system and meter room as specified by Competent Electric Company.

- 9 Open to sky space used for solar-water heating system, outdoor units for air conditioners or mechanical ventilation.
- 10 In common plot the permissible built-up area of common facility shall not be considered towards computation of FSI as per Rule 7.15.5.
- 11 Balconies up to 33% of the perimeter of a building.
- 12 Pergolas as defined in these Rules.
- 13 Refuge area required as per Fire Rules in Part 3 (II) and Service floor used for providing MEP (Mechanical Electrical and Plumbing), AHU (Air Handling Units). Air Conditioning Systems and Fire Equipment may be exempted from computation of FSI. Provided that the Competent Authority shall ascertain the aforesaid exemptions based on the testimonial submitted with reasons to it.
- 14 Double height foyer shall be deducted once while computation of FSI.
- 15 Fire escape stairs.
- 16 Effluent Treatment Plants to be provided by industries as per requirements of Pollution Control Board or Competent Authority.

7.3.3 Transfer of Development Rights (TDR)

TDR certificate shall be granted by the PDA under the following conditions:

1 Outline Development Plan Roads / Access Roads / Public Works

In case a building unit is affected by road widening or construction of new road (Outline Development Plan or Access Road) which may include laying down of any public utility on road or public purpose development work, the owner may claim FSI in lieu of compensation from the Competent Authority for the land surrendered which is affected by such project. In case of FSI, the Competent Authority shall permit the FSI of the land / plot surrendered on same building unit or issue a TDR certificate for the surrendered land which may be used in the recipient zones as mentioned in Table No 7.5.

2 Preservation Zone I, II, Recreational Zone I, Transportation, Eco-Sensitive Zone, Airport- No Development Zone

In case a building unit is impacted by Preservation Zone I, II, Recreational Zone I, Transportation, Eco- Sensitive Zone, Airport- No Development Zone, the owner may claim FSI from the Competent Authority provided he / she surrenders the land under this zone to the Competent Authority. The Competent Authority shall issue a TDR certificate for the surrendered land which may be used in the recipient zones as mentioned in Table No 7.5. While no FSI is attributed to these zones and the TDR will be issued at a notional FSI of 1.

3 Unusable Plot

A plot will be deemed unusable, at the option of the owner or developer, if the possible plinth area left for development as per these Rules is less than 20 sq m or one of the dimensions of the plinth area is less than 3 m. In such cases, the plot owner shall be entitled to claim TDR for the entire plot, calculated as per base FSI, after surrendering the land to the Competent Authority.

Table No. 7.6: Transfer of Development Rights for the Respective Zone, Daman District

No. (1)	Zones (2)	Remarks (3)
1	Preservation Zone -I (CRZ IA and IB)	<ul style="list-style-type: none"> • The FSI is Nil. • TDR may be issued by Competent Authority considering a notional FSI of upto 1 and subject to surrendering of land to Competent Authority who then may develop these as urban greens. The TDR can be used in zones indicated in Table 7.5 of Rule No. 7.3.1
2	Preservation Zone -II (CRZ IA)	<ul style="list-style-type: none"> • The FSI is Nil. • TDR may be issued by Competent Authority considering a notional FSI of upto 1 and subject to surrendering of land to Competent Authority who then may develop these as urban greens. The TDR can be used in

No.	Zones	Remarks
(1)	(2)	(3)
		zones indicated in Table 7.5 of Rule No. 7.3.1
3	Recreational Zone -I	<ul style="list-style-type: none"> The maximum permissible FSI is 0.15. The owner may use this in the balance plot and leave it vacant OR TDR may be issued by Competent Authority considering a notional FSI of upto 1 and subject to surrendering of land to Competent Authority who then may develop these as urban greens. The TDR can be used in zones indicated in Table 7.5 of Rule No. 7.3.1
	Recreational Zone -IB (CRZ IB)	<ul style="list-style-type: none"> The FSI is Nil. TDR may be issued by Competent Authority considering a notional FSI of upto 1 and subject to surrendering of land to Competent Authority who then may develop these as urban greens. The TDR can be used in zones indicated in Table 7.5 of Rule No. 7.3.1
4	Recreational Zone -IC (CRZ III- NDZ)	<ul style="list-style-type: none"> The FSI is Nil. TDR may be issued by Competent Authority considering a notional FSI of upto 1 and subject to surrendering of land to Competent Authority who then may develop these as urban greens. The TDR can be used in zones indicated in Table 7.5 of Rule No. 7.3.1
5	Recreational Zone -ID (CRZ III- Beyond NDZ)	<ul style="list-style-type: none"> The maximum permissible FSI is 0.33. The owner may use this in the balance plot and leave it vacant OR TDR may be issued by Competent Authority considering a notional FSI of upto 1 and subject to surrendering of land to Competent Authority who then may develop these as urban greens. The TDR can be used in zones indicated in Table 7.5 of Rule No. 7.3.1
6	Recreational Zone -IIA (CRZ IA)	<ul style="list-style-type: none"> The FSI is Nil. TDR may be issued by Competent Authority considering a notional FSI of upto 1 and subject to surrendering of land to Competent Authority who then may develop these as urban greens. The TDR can be used in zones indicated in Table 7.5 of Rule No. 7.3.1
7	Recreational Zone- IIC (CRZ III – NDZ)	<ul style="list-style-type: none"> The FSI is Nil. TDR may be issued by Competent Authority considering a notional FSI of upto 1 and subject to surrendering of land to Competent Authority who then may develop these as urban greens. The TDR can be used in zones indicated in Table 7.5 of Rule No. 7.3.1
8	Recreational Zone -IID (CRZ III- Beyond NDZ)	<ul style="list-style-type: none"> The maximum permissible FSI is 0.33. The owner may use this in the balance plot and leave it vacant OR TDR may be issued by Competent Authority considering a notional FSI of upto 1 and subject to surrendering of land to Competent Authority who then may develop these as urban greens. The TDR can be used in zones indicated in Table 7.5 of Rule No. 7.3.1
9	Core Area and Gaothan/ Gamtal -A (CRZ IA)	<ul style="list-style-type: none"> The FSI is Nil. TDR may be issued by Competent Authority considering a notional FSI of upto 1 and subject to surrendering of land to Competent Authority who then may develop these as urban greens. The TDR can be used in zones indicated in Table 7.5 of Rule No. 7.3.1
10	Industrial Zone - IC (CRZ III – NDZ)	<ul style="list-style-type: none"> The FSI is Nil. TDR may be issued by Competent Authority considering a notional FSI of upto 1 and subject to surrendering of land to Competent Authority who then may develop these as urban greens. The TDR can be used in zones indicated in Table 7.5 of Rule No. 7.3.1
11	Development Zone -IB (CRZ IB)	<ul style="list-style-type: none"> The FSI is Nil. TDR may be issued by Competent Authority considering a notional FSI of upto 1 and subject to surrendering of land to Competent Authority who then may develop these as urban greens. The TDR can be used in zones indicated in Table 7.5 of Rule No. 7.3.1
12	Development Zone -IC (CRZ III- NDZ)	<ul style="list-style-type: none"> The FSI is Nil. TDR may be issued by Competent Authority considering a notional FSI of upto 1 and subject to surrendering of land to Competent Authority

No.	Zones	Remarks
(1)	(2)	(3)
		who then may develop these as urban greens. The TDR can be used in zones indicated in Table 7.5 of Rule No. 7.3.1
13	Development Zone -ID (CRZ III - Beyond NDZ)	<ul style="list-style-type: none"> The maximum permissible FSI is 0.33. The owner may use this in the balance plot and leave it vacant OR TDR may be issued by Competent Authority considering a notional FSI of upto 1 and subject to surrendering of land to Competent Authority who then may develop these as urban greens. The TDR can be used in zones indicated in Table 7.5 of Rule No. 7.3.1
14	Development Zone -IIC (CRZ III - NDZ)	<ul style="list-style-type: none"> The FSI is Nil. TDR may be issued by Competent Authority considering a notional FSI of upto 1 and subject to surrendering of land to Competent Authority who then may develop these as urban greens. The TDR can be used in zones indicated in Table 7.5 of Rule No. 7.3.1
15	Development Zone -IID (CRZ III – Beyond NDZ)	<ul style="list-style-type: none"> The maximum permissible FSI is 0.33. The owner may use this in the balance plot and leave it vacant OR TDR may be issued by Competent Authority considering a notional FSI of upto 1 and subject to surrendering of land to Competent Authority who then may develop these as urban greens. The TDR can be used in zones indicated in Table 7.5 of Rule No. 7.3.1
16	Airport – No Development Zone	<ul style="list-style-type: none"> The FSI is Nil. TDR may be issued by Competent Authority considering a notional FSI of upto 1 and subject to surrendering of land to Competent Authority who then may develop these as urban greens. The TDR can be used in zones indicated in Table 7.5 of Rule No. 7.3.1

7.4 Minimum Area of Building Unit for Different Uses

The minimum area of a building unit shall be 30 sq m with no side less than 3.0 m in width in Core & Gamtal / Gaothan area and 40 sq m in non-Core area. Provided that, if the building unit size less than this is existing in revenue records, minimum area of building unit shall not be applicable.

To ensure that a use meets the various requirements of these Rules and other regulations, minimum building unit size requirements are indicated in Table No. 7.7.

Table No. 7.7: Use and Minimum Building Unit Size Requirement

No.	Use / Type	Minimum Building Unit Size (sq m)	Minimum Width of Building Unit (m)
(1)	(2)	(3)	(4)
1	Dwelling (Core & Gamtal / Gaothan)	30	3
2	Dwelling (For Subdivision/ Layout refer table no. 7.8 below)	40	5
3	Row Houses	1000	
4	Farmhouse	4400	
5	Mercantile 1	200	
6	Mercantile 2 and 3	800	15
7	Education 1	300	
	Anganwadi / Day Care / Pre School		
	Pre-Primary School		
8	Education 2	1600	
	Primary Schools	1600	
	Secondary Schools	1600	
	Higher Secondary Schools	2400	
9	Education 3	3500	
	Polytechnic		
	Industrial Training Institutes (ITI) / Vocational Training Centre		

No.	Use / Type		Minimum Building Unit Size (sq m)	Minimum Width of Building Unit (m)
(1)	(2)		(3)	(4)
		College University and ancillary use Research and Development Centres		
10	Assembly 1, 2, 3, and 4		1500	20
11	Industry		800	20
12	Service Industry 2		800	
13	Public Offices		250	
14	Fuelling station without service station		600	20
15	Fuelling with service station		1200	30
16	eV station with service station		As per GOI Guidelines	
17	eV station w/o service station		As per GOI Guidelines	
18	Hospitality 3		500	
19	Health 1	PHC, Clinic (with & without indoor facilities)	1000	
		Dispensary	250	
		Health and Wellness Centre /Ayushman Bharat	300	
20	Health 2	Indoor Hospital facility up to 20 Bed	2000	
		Surgical Hospital, Nursing Home, Maternity Home	2000	
		Community Health Centre	4000	
		Veterinary Facilities	2000	
21	Health 3	Multi-specialty hospital- Upto 100 beds	10,000	20
		Medical College and Research Centre	20,000	20
		Hospital - More than 100 Bed		
22	Health 4	Hospital for infectious diseases	20,000	20
		Mental Hospital / Asylum		

Note: For minimum sizes of Affordable Housing – Plotted is 25 Sqm

Table No. 7.8: Minimum Plot size for Subdivision/ Layout

No.	Type of Development	Minimum Plot Area (sq m)	Minimum Width of Frontage (m)
1	Row Housing	50	8
2	Semi Detached Housing	150	10
3	Detached Housing	200	10
4	Group Housing Societies	1500	15
5	Residential + Mercantile	800	15
6	Service Light Industries	800	20

7.5 Approach Road / Access to Building Unit

7.5.1 Approach Road / Means of Access

- 1 Minimum Road width on which any development shall be allowed is 12 m except for Core Area and Gamtal / Gaothan Zone. In case the proposed use or plot size in case of industrial use, demands a certain road width (Table No. 7.12) then it shall be considered in place of 12 m.
- 2 The designated roads widths in the Outline Development Plan are indicated in Table No 7.9.

Table No. 7.9: Road Widths in Outline Development Plan

No	With of Roads (m)
1	12.00
2	15.00
3	18.00
4	25.00
5	30.00
6	45.00

- 3 For building units along overbridge or underbridge, the total width of the road including the these shall be considered for regulating permissible uses, margin, and height for proposed buildings.
- 4 In case the building unit abuts an existing road and not an Outline Development Plan Road / Town Planning Scheme Road, the right of way / plot boundary shall be considered as minimum 6.0 m from the centre line of such an existing road or more as decided by the Competent Authority. Roadside margin shall be considered from this imaginary plot boundary thus established. This additional land to be left is defined as ‘setback’. TDR for the land under setback will be given on the balance plot or can be used in zones indicated in Table No. 7.5 of Rule No. 7.3.1(Refer Figure No. 7.2).

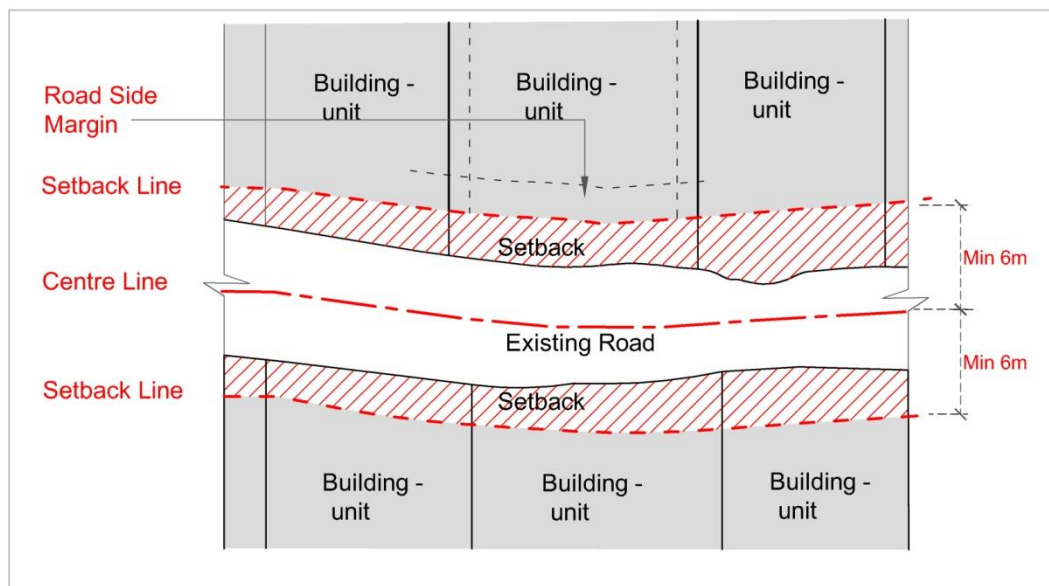

Figure No. 7.2: Building Unit Abuts the Existing Road

7.5.2 Land Locked Building Unit and Required Road Width

- 1 In the case of a land locked plot, which is surrounded on all sides by other plots and there is no Outline Development Plan Road / existing road, access road of minimum 12 m width shall be required through adjoining plots or plot to the nearest street or road. It shall be provided by the Owner at his / her cost and shall meet any other condition as prescribed by the Competent Authority. The road access cannot be a point access, the road should continue through the plot (Refer Figure No. 7.3).



Figure No. 7.3: Land Locked Building Unit

- 2 In case of land locked plot surrounded by existing construction and a 12 m. wide approach road is not feasible, then uses as per Table 7.4 on less than 9 m shall be permitted in case the plot has received non - agriculture permission prior the publication of these Rules. For non-agriculture permission granted after the publication of these Rules, 12 m wide road shall be insisted upon.
- 3 For Non-Town Planning Area, the development permission shall be regulated as per the road network proposed by the Competent Authority. Competent Authority shall be authorised to declare new roads for the land locked plots, where the access to the said plots is secured by the developer, and grant TDR to all the plots which are affected by the said proposed roads. Provided that the access provided shall be in conformity with the proposed development.

7.6 Building Height

- 1 Subject to present Rules and any other Rules for the time being force, and subject to any clearance that may be required from any authority, the maximum permissible building height is 45 m.
- 2 The following shall not be considered towards computing the height:
 - a) Parapet.
 - b) Stair-case cabin.
 - c) Water storage tank.
 - d) Lift well, lift cabin with machine room above.
 - e) Roof top solar panel installation.

7.7 Margins

Margins / open space have to be maintained between the boundary of the building unit and building/s as follows.

7.7.1 Roadside Margin or Front Margin

- 1 Roadside margin for a building unit shall be regulated by the road width it abuts on and shall be as given in Table No 7.10, 7.11 and 7.12.
- 2 For building units with two or more abutting roads, the roadside margin shall be applicable on all such abutting sides as illustrated in the figure (Refer Figure No. 7.4).
- 3 In case of setbacks required for widening an existing street for access, margins have to be kept after the setback and land in the setback will become a part of road. Land contributed towards the street will be compensated by the way of TDR on the balance plot or TDR can be used in zones indicated in Rule No. 7.3.1.
- 4 In case the declared ROW in Outline Development Plan or otherwise is more than the existing road on site and the Competent Authority has not acquired the road, land contributed towards the ROW will be compensated by the way of TDR.

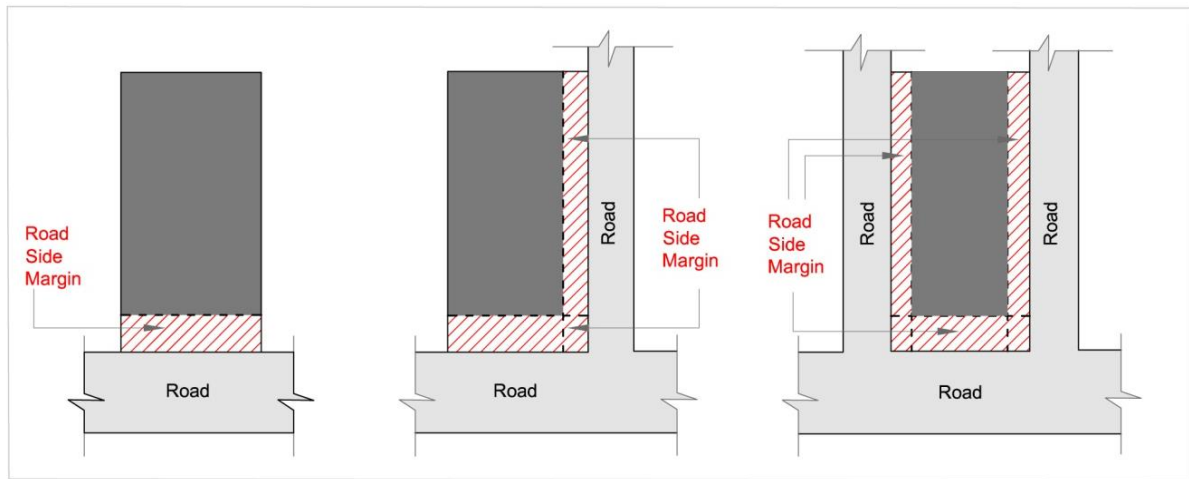

Figure No. 7.4: Roadside Margin / Front Margin

Table No. 7.10: Roadside Margin (Non-Core Area and Gamtal / Gaothan) Except Industrial Use

No	ROW (Right of Way)	Roadside Margin (From the centreline of the road)
1	Less than and equal to 6m (Internal Road)	5.00
2	Greater than 6 and equal to 9 m (Internal Road)	7.00
3	Greater than 9 and equal to 12 (ODP Road)	9.00
4	Greater than 12 and equal to 15 m (ODP Road)	12.00
5	Greater than 15 and equal to 18 m (ODP Road)	15.00
6	Greater than 18 and equal to 25 m (ODP Road)	19.50
7	Greater than 25 and equal to 45 m (ODP Road)	30.50
8	Greater than 25 and equal to 45 m (NH/SH)	36.50

Note: Roadside margin for Special Buildings – 12 m

Table No. 7.11: Roadside Margin (Core Area and Gamtal / Gaothan)

No	Road Width	Roadside Margin (From the centreline of the road)
1	Less than and equal to 6m (Internal Road)	5.00 (On roads identified by the authority)
2	Greater than 6 and equal to 9 m (Internal Road)	7.00
3	Greater than 9 and equal to 12 (ODP Road)	9.00
4	Greater than 12 and equal to 15 m (ODP Road)	12.00
5	Greater than 15 and equal to 18 m (ODP Road)	15.00
6	Greater than 18 and equal to 25 m (ODP Road)	18.50
7	Greater than 25 and equal to 45 m (ODP Road)	30.00
8	Greater than 25 and equal to 45 m (NH / SH within Municipal Limits)	30.00

Note: Roadside margin for Special Buildings – 12 m

Table No. 7.12: Roadside Margin (For Industrial)

No	Road Width	Roadside Margin (From the centreline of the road)
1	Greater than 9 and equal to 12 (ODP Road)	12.00
2	Greater than 12 and equal to 15 m (ODP Road)	13.50
3	Greater than 15 and equal to 18 m (ODP Road)	18.00
4	Greater than 18 and equal to 25 m (ODP Road)	21.50
5	Greater than 25 and equal to 45 m (ODP Road)	31.50
6	Greater than 25 and equal to 45 m (NH/SH)	36.50

7.7.2 Rear and Other Side Margins

1 Rear and side margins shall be as per Table No. 7.13.

Table No. 7.13: Rear and Side Margins

No.	Use	Area of Building Unit (BU) (sqm)	Rear Margin (m)	Side Margin (m)	Remarks
(1)	(2)	(3)	(4)	(5)	(6)
1	Dwelling 1, 2 (Subject to BH less than 16.5 m)	PS ≤ 25	Not Required	Not Required	Only G+1 floor
		PS > 25 & ≤80	-	-	1.0 on any one side including rear side
		PS > 80 & ≤150	-	-	1.5 on any one side including rear side
		PS>150 & ≤300	2.00	1.5 (Any one side)	-
		PS >300 &	2.5	1.5	-

No.	Use	Area of Building Unit (BU) (sqm)	Rear Margin (m)	Side Margin (m)	Remarks
(1)	(2)	(3)	(4)	(5)	(6)
		≤500		(Both sides)	
		PS > 500	3.00	3.0 (Both sides)	-
2	Other than above	BH ≤ 17.5 m	3.0	3.0	
		BH > 17.5 m & BH ≤ 25m	4.5	4.5	For PS ≤ 750 sq m, required margins shall be 3 m, for building height upto 17.5 m.
		BH > 25 m & BH ≤ 45 m	6.0	6.0	
3	Industrial use	PS > 800 & ≤ 2000	4.5	4.5	4.5 m on any two sides including rear
		PS > 2000 & ≤ 5000	6	6	All three
		PS > 5000 & ≤ 10000	9	9	
		PS > 10000	12	12	
4	Special Buildings	BH upto 25 m	6	6	
		BH greater than 25	8	8	
5	Warehouse / Godown	Irrespective	6	6	
6	Fuelling Station with and without service station	Irrespective	9*	9*	
Notes: PS = Building Unit / Plot Size BH = Building Height					

*Note- Subjected to minimum rear and side margin for administrative building & service station in fuelling station can be 4.5m

7.7.3 Margins between Buildings and Common Plot

Table No. 7.14: Margins between Two Buildings and Margin from Common Plot

No.	Building Height upto (m)	Margins (m)
(1)	(2)	(3)
1	Margin between two buildings	4.5 m for buildings less than 25 m in height 6 m for buildings 25 m and above in height
2	Margin from Common Plot	3 m for buildings less than 25 m in height 6 m for buildings 25 m and above in height

7.7.4 Permissible Uses in Margin (Refer Figure No. 7.5)

1 For Dwelling 1, 2 and 3 (except Row house):

- Ancillary uses such as parking garage, servant quarter, WC and bathroom shall be permitted at any zone, in side or rear margin space but in no case in roadside margins subject to clear movement for fire tender where required. The area of such uses shall not exceed 16.5 sq m on ground and the height shall not exceed of 3 m.
- Surface water tank up to 1.5 m in height.
- Open staircase, cantilever staircase with maximum width of 1 m and staircase landing of maximum 2 m at floor level shall be permitted in side or rear margins except on road side margin.

Provided that, for Dwelling 1 and 2, in case of plots not exceeding 150 sq m, 1 m wide stair may be allowed. However, the stair may be allowed after keeping 1.5 m margin if the plot abuts on 6 m wide road. Further if the plot abuts on 7.5 m wide road the stair may be allowed from the plot boundary.

- d) Doors, windows, or projections shall not be permitted along the common wall of the semi-detached adjoining property. No rainwater from the roof shall be drained in the adjoining property.
 - e) Partition wall shall be allowed along the building unit boundary on common boundary of semi-detached building and on margin space between two structures up to a maximum height of 1.5 m.
 - f) Underground water tank, percolation well, bore well and pump room with a maximum size of 2 m x 2 m and with a maximum height of 2 m.
 - g) Margin shall not be required in case of building having approach from internal /approach road.
- 2 Building units of all uses other than Industrial, and Public Offices: A structure (only prefab) for security cabin including toilet with maximum dimensions of 2 m X 4 m, with maximum height of 3 m shall be permitted in the roadside margin subject to leaving clear access for fire tender movement.
 - 3 For Industrial, and Public Office use: a security cabin structure up to a maximum ground coverage of 16.5 sq m with maximum height of 3.0 m shall be permitted in the roadside margin subject to leaving a clear access for fire tender movement with a minimum width of 4.5 m from the building.
 - 4 Pedestrian access path, ramp, and stepped approach as prescribed shall be permissible in the marginal space.
 - 5 Common plots shall be permitted in the marginal space.
 - 6 Vehicular Ramp connecting the ground level with basement level 1 shall be permitted in side and rear margin as per Table No. 13.4 and 13.5 provided there is unhindered movement for fire tender on three sides. It should not start before the line of the roadside margin back OR it should commence only after the front / roadside margin line.
 - 7 Electrical Infrastructure: Electrical sub-station, transformer room, box-type transformer, section feeder pillar, auxiliary power back-up system and meter room according to the norms of the Competent Electric Company shall be permitted in side margin space but not on the road side margin of the building unit.

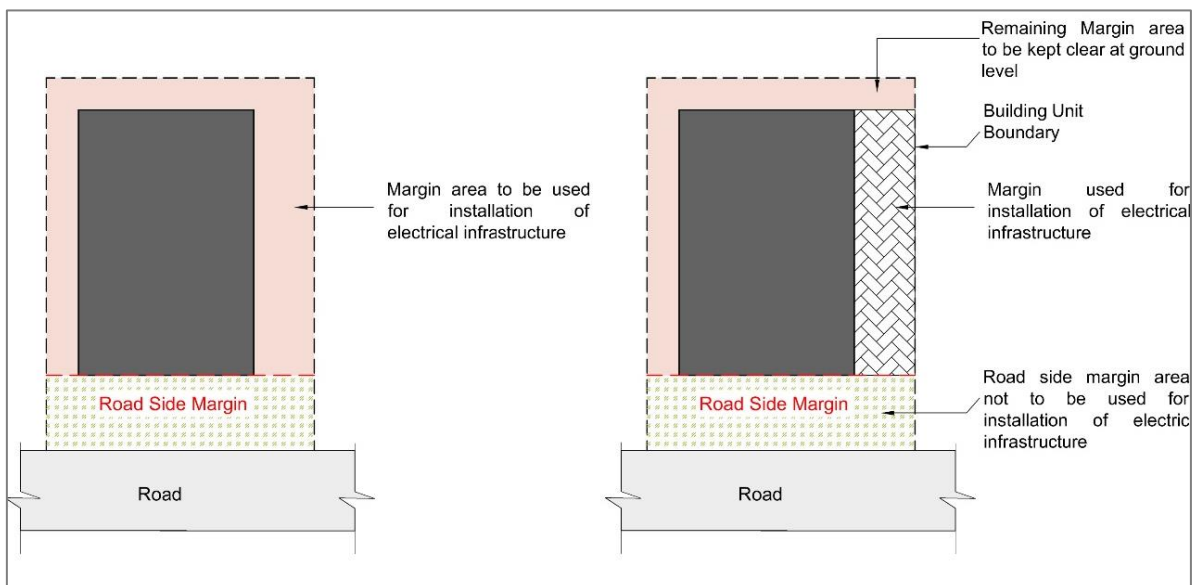

Figure No. 7.5: Margin to be Used for Electric Infrastructure

- 8 For a building unit using marginal space for providing electrical infrastructure as per Rule 7.7.4 (7) and underground water tank as per Rule 7.7.4 (1f), these permissible uses shall be allowed

only one margin side except roadside margin. The other margin spaces shall be kept clear and accessible at ground level (*Refer Figure No. 7.5*).

- 9 Cantilever refuge area for building with height more than 25 m may be permitted subject to Fire Rules.
- 10 Parking shall be permitted in margins except in access path from gate to staircase (*Refer Figure No. 7.6*). If contiguous with parking in hollow plinth, provided with minimum dimension of 6 m, or contiguous with overall parking layout. No sheds shall be constructed for parking in margins.

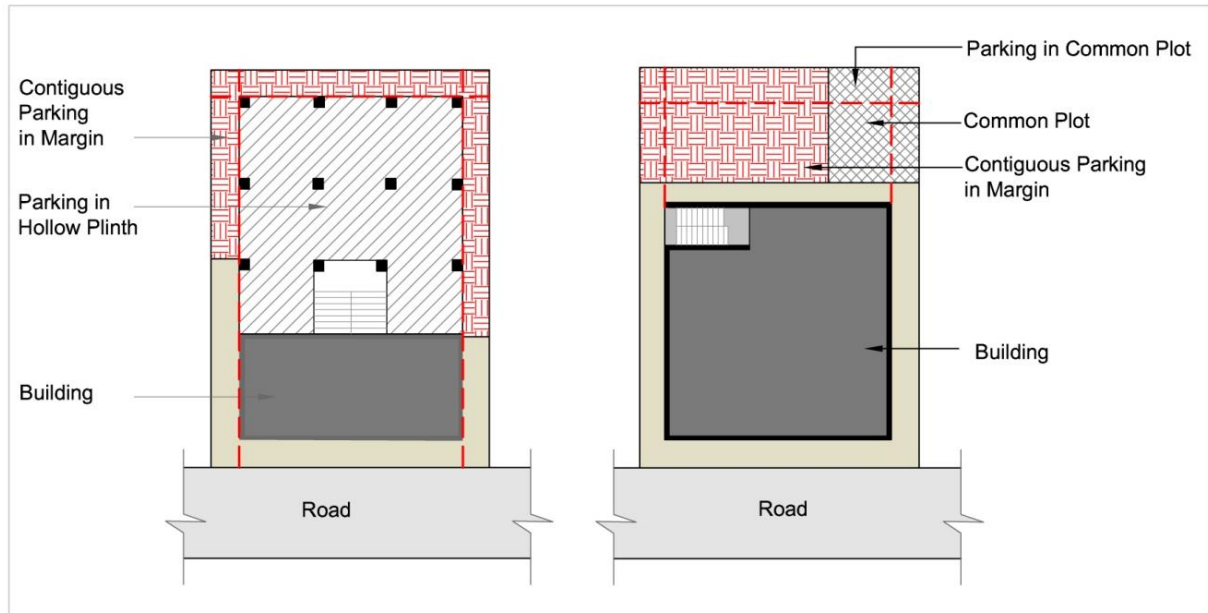

Figure No. 7.6: Details of Permissible Parking

- 11 Basement shall be permitted within side and rear margins after leaving 3 m margin from the boundary of the building unit.
- 12 In any marginal open space, weather sheds sun breakers horizontal or vertical projections shall be permitted up to 0.60 m. These projections may also be part of the façade articulation at various levels but shall in no cases they become a part of the habitable space. Such projections shall be allowed above a minimum height of 2.4 m from the ground level.
- 13 Balcony projection may be permitted upto 33% of the perimeter of the building and it should not be more 50% of the margin width or 1.2 m in width, whichever is less. In case of buildings other than Dwelling 1 and Dwelling 2, the balcony projection should be above 6.5 m height to enable clear fire tender movement.
- 14 For a building unit with uses – Dwelling 1, Assembly 1 & 2, Education 1, 2, & 3, Public Offices, Health 1, 2, 3 & 4; the building unit level may be permitted to be raised up to plinth level.
- 15 Porch having 4.5 m minimum height shall be permitted in margin, at ground level subject to the condition that 4.5 m clear circulation space is kept for fire tender movement.
- 16 Special Buildings
 - a) The roadside margin may be permitted to be covered up to 6 m from the building line with a projected cantilever structure (porch) at a height of not less than 3 m from the ground level.
 - b) Parking shall be permitted in roadside margin after leaving minimum 6 m from the building unit boundary. This minimum 6 m shall be utilised for shade giving trees and plantation purpose ensuring clear movement for fire tender.
- 17 Sky walk shall be permissible in margin. However, it shall not be at a height less than 10.50 m.
- 18 Cantilever projection can be permitted after leaving the required margin.
- 19 Portable structures maximum upto 3 m height and security cabin of 2.4 m x 1.8 m shall be permitted. Space for fire tender should be kept clear.

7.7.5 Restriction on Development in Margin

- 1 The required margin open spaces except for permissible uses as per Rule No. 7.7.4 shall be kept permanently open to sky.
- 2 This space shall not be used for stocking materials or loose articles for the purpose of trade or otherwise, putting up fixed or movable platforms.
- 3 Parking shall be allowed in the rear and side margin space after keeping minimum required marginal spaces the case of building height more than 25 m.
- 4 Vehicular or Pedestrian ramp/s leading to parking in floors above ground level shall be permitted after keeping required margin.
- 5 The sunk in lower ground floor or basement provided for the purpose of light / ventilation shall not be permitted in the marginal open space.
- 6 No difference shall be permitted in the ground level of the margin space of the building even in cases where the permitted margin of the basement is lesser than the permitted margin of the super structure.

7.8 Basement in a Building Unit

Atleast half of the clear floor height of the basement shall be below the ground level (*Refer Figure No. 7.7*).

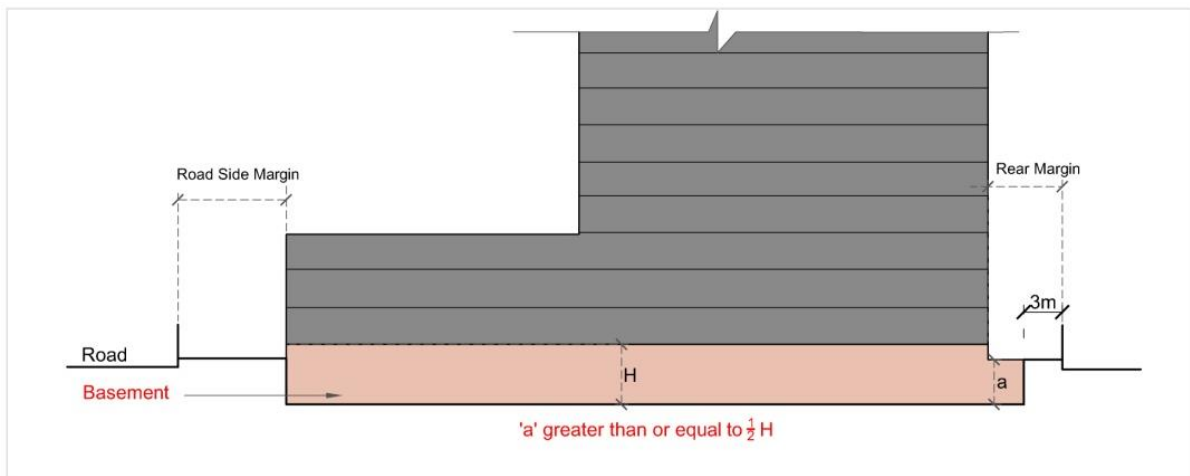

Figure No. 7.7: Basement or Cellar

7.8.1 Margins

- 1 No basement shall be permitted in the required roadside margin space and within required set back area in case of Gamtal / Gaothan and core area.
- 2 Subject to Sub Rule 1, the side and rear side margins for the basement shall be 3 m from the building unit / plot boundary. A combined shared basement parking shall be permitted using full margin space other than roadside margin of building unit with the consent of the adjoining building unit owner for new development provided that the last building in such cases shall have to leave at least 3 m from the building unit boundary.
- 3 For building units with area less than 500 sq m, basement shall be permitted with margins as per Rule No. 7.7.4. A minimum margin of 3 m is required from the common wall of adjacent existing building.
- 4 Basement shall be permitted under common plot, internal road, and internal marginal space for exclusive use of parking only with adequate structural safety during construction in case of construction on a single building unit.
- 5 In cases where the permitted margin of the basement is lesser than the permitted margin of the super structure, no level difference shall be permitted in the margin space of the building. Such margin space shall be open to sky and motorable to enable fire tender movement.

7.8.2 Extent

- 1 Basement shall not be allowed for the purpose of parking for building units with area less than or equal to 250 sqm.
- 2 Only one level below ground level of basement can be used for any use other than parking. For parking, basement can be permitted at more levels than one

7.8.3 Height

Maximum clear height of the basement shall be 4.50 m and minimum clear height shall be 2.80 m from finished basement to the bottom most soffit of beam/slab, whichever is applicable (*Refer Figure No. 7.8*).

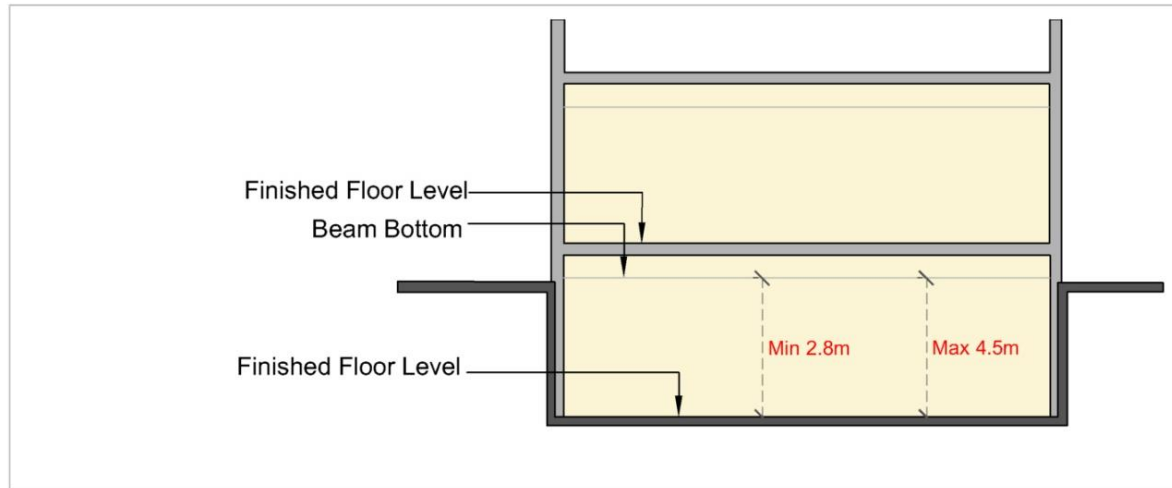

Figure No. 7.8: Height of the Basement

7.8.4 Permissible Uses

- 1 No residential use shall be allowed in basement under any circumstances.
- 2 Uses permitted in a basement are – parking, safe deposit vault, AC Plant, grey water treatment plant, sewage treatment plant, water tank and storage other than inflammable material.
- 3 Uses permitted in the basement of a hospital building are – radiation producing device, radiation therapy room, MRI, or X-Ray room.
- 4 Commercial use like shopping complex, mall, for one level below ground may be allowed subject to adequate (should be specified properly) central open space to ensure light and air into basement. Such use shall not be allowed in covered basement.
- 5 For basements exclusively for parking, any other permissible use is permitted only in basement level 1 up to a maximum area of 25% of the total built-up-area of the basement floor. This non-parking area shall be calculated towards the computation of FSI.
- 6 Other permissible uses of the basement can be allowed for two levels below ground. However, parking can be permitted for up to 4 levels below ground subject to removal of water, adequate provision of air, and structural issues.

7.8.5 Services

No water connection or drainage connection shall be permitted in the basement. In no case shall a connection with normal drainage line be provided in the basement.

7.8.6 Basement (Core Area and Gamtal / Gaothan)

- 1 No basement shall be permitted within required front road set back.
- 2 While construction of a basement adequate structural safety shall be adopted.
- 3 One level basement for parking shall be permitted in building unit area more than 300 sq m. and two levels if building unit area is more than 1500 sq m.
- 4 Permitted uses in Basement:
 - a) Parking, safe deposit vault, AC plant, storage other than inflammable material.
 - b) No habitable use shall be permitted in the basement.

- c) Uses permitted in the basement of a hospital building are – radiation producing device, radiation therapy room, MRI, or X-Ray room.
 - d) For basements exclusively for parking, any other permissible use is permitted only in basement level 1 up to a maximum area of 25% of the total built up area of the basement floor. This non-parking area shall be calculated towards the computation of FSI.
- 5 During construction of basement, necessary shoring and strutting including sheet piling shall be required.
 - 6 Material used for construction of basement shall be fire resistant. Wood or any other combustible material shall not be used as structural members of a basement.
 - 7 No direct entry from the road shall be permitted to the basement. Access to the basement to be provided as per Fire regulations.
 - 8 In cases where the permitted margin of the basement is lesser than the permitted margin of the super structure, no level difference shall be permitted in the marginal space of the building. Such marginal space shall be open to sky and motorable as per these Rules.
 - 9 During construction of basement, necessary shoring and strutting including sheet piling shall be required.

7.9 Addition to an Existing Structure / Building

- 1 Any addition to an existing structure / building shall comply with these Rules and is to be treated as a new construction.
- 2 For approved, individual, existing, detached, and semi-detached dwelling units, permissible upper floors may be permitted as per sanctioned margins, staircase, projections, and structural safety.
- 3 Additions and/or alterations in Core Area and Gamtal / Gaothan:
 - a) Any addition to an existing structure / building shall comply with these Rules and is to be treated as a new construction.
 - b) No addition or extension to a building shall be allowed unless the addition or extension is such as would be permissible if the whole building were reconstructed from the plinth with the open spaces required under the Rules applicable to the site of the building at the time of the proposed addition or extension.
 - c) No addition or extension to a building shall be allowed which would diminish the minimum extent of open-air space which is required by the Rules applicable to the site of the building at the time of the proposed addition or extension.

7.10 Addition in Building Units with Existing Buildings

- 1 For building units with approved existing buildings, additional buildings shall be permitted with compliance to these Rules for construction of a new building.
- 2 The additional buildings shall be permitted as per remaining FSI (i.e., after deducting the utilised FSI of the approved existing building from the maximum permissible FSI of the entire building-unit) with compliance to respective margins, permissible height, structural safety, uses and all other applicable regulations.

7.11 Row House and Tenement Type Buildings

7.11.1 Row Type Buildings

- 1 The minimum area of plot on which row houses are to be constructed shall be 1000 sq m.
- 2 The minimum length of common wall between the two adjacent row houses shall be 50% of the depth of the row house.
- 3 The minimum size of an individual sub plot of a row house shall be 40 sqm and the minimum width of the plot shall not be less than 3 m.
- 4 Minimum margin in the front shall be 2 m and rear margin shall be 2.50 m. The end plot in a row house shall also have minimum side margin of 2 m on the side abutting on road.

- 5 6 m wide space open to sky shall be provided at the end of every such 10 continuous houses of row houses.
- 6 Basements are permitted, after the stipulated margins.
- 7 Requirement for common plot shall be as prescribed irrespective of number of row houses to be developed.
- 8 In case of Row house type building, the width of internal approaches/road for such development shall be regulated as per Table No. 7.15.

7.11.2 Tenement Type Buildings

- 1 The minimum length of common wall between the two adjacent tenements shall be 50% of the depth of the tenements.
- 2 In case of tenements type building, the width of internal approaches/road for such development shall be regulated as per Table No. 7.15.
- 3 Minimum requirement of margin, parking, and other applicable regulations as per Dwelling-2 category.

Table No. 7.15: Width of the Internal Road based on the Length of Road

No.	Length of road (m)	Width of Road for Residential Use (m)	Width of Road for Non-Residential Use (m)
(1)	(2)	(3)	(4)
1	Up to 15 or less (Approach)	3.0	4.5
2	Above 15 and up to 50 (Approach)	4.5	6.0
3	Above 50 and up to 150	7.5	9.0
4	Above 150 and up to 450	9.0	12.0
5	Above 450	12.0	15.0

Note: The aforesaid provision shall be applicable to industrial row type building layouts.

7.12 Provision for Podium

Means a horizontal platform, projecting or otherwise, extending beyond the building footprint on one or more sides, and may consist of one or more levels.

7.12.1 Uses Permitted

Podium may be used for the following purposes which may be standalone or in combination:

- 1 Parking of vehicles,
- 2 Other uses as permissible in respective zone may be allowed by counting it in FSI subject to light, ventilation and fire safety requirements and other regulations as specified in these regulations.
- 3 Topmost portion of podium slab which is open to sky maybe landscaped and / or be used as recreational open space, common plot, subject to provision of 2.0 m high parapet wall.

7.12.2 General Requirements

- 1 Podium may be allowed for plots having area equal or more than 4000 sq m.
- 2 Height of podium shall not exceed 15 m from ground level.
- 3 Podium shall be allowed after leaving minimum 6 m distance form plot boundary or required set back / front margin whichever is higher after leaving space for movement for fire tenders.
- 4 Podium shall be allowed at a distance of 6 m from the plot boundary other than front side.
- 5 Common plot shall be permissible from the boundary of the top slab of podium subject to other regulations related to common plot.
- 6 The structural design of podium slab and ramp should be of adequate strength to bear the load of fire engines and vehicles.
- 7 The consent from The Fire Officer shall be necessary before permitting the aforesaid podium.
- 8 Ramp leading to basement, or any other floors or podium shall be regulated as per Table No. 13.5.

- 9 In case a podium is not provided with ramp, but provided with car lift only, the same may also be permitted in one or more levels, however, the total height shall not exceed 9.0 m above ground level.
- 10 Requirement of accessibility for elders and persons with disabilities shall be ensured as mentioned in these Rules-which may require providing ramps with specified gradient or accessible lifts for access to different levels.
- 11 Passenger lifts, fire lift, vehicular lift, shall be provided as mentioned in Rule No. 13.12.

Table No. 7.16: Width of Ramp for Vehicle

Type of Vehicle	Type of Ramp	Width of Ramp (M)
(1)	(2)	(3)
LMV	One Way	3.00
	Two Way	6.00
LCV	One Way	4.50
	Two Way	9.00
HMV	One Way	6.00
	Two Way	12.00
Fire Tender	-	7.50

Note:

- 1 Minimum Radius of Inner Curvature shall be 4.5 m
- 2 The maximum slope shall be 1:7 and if podium is accessible for fire tender maximum slope of ramp shall be 1:10.
- 3 After a 40 m length of continuous ramp, a flat surface of minimum 6 m length shall be provided.
- 4 Abbreviations: -
 - a) LMV- Light Motor Vehicle
 - b) LCV- Light Commercial Vehicle
 - c) HMV- Heavy Motor Vehicle.

- 12 Heavy Motor Vehicles (HMV) shall not be permitted on podium and floors other than ground floor and basements.
- 13 Maximum projection from the footprint shall not exceed 11 m.

7.12.3 Requirements for Fire Tender Movement

- 1 Building having height more than 15 m without stilt and 17.50 m with stilt above ground level shall necessary be accessible by fire tender as below (*Refer Figure No. 7.9*).
 - a) For buildings having floor area less than or equal to 10,000 sqm, fire tender shall have access to at least 1/3 of the perimeter of the building which shall be minimum 6 m wide and having 9 m turning radius
 - b) For buildings having floor area more than 10,000 sqm, fire tender shall have access to at least half of the perimeter of the building which shall be minimum 6 m wide and having 9 m turning radius
- 2 If podium is not accessible by fire tender, the podium may be such that it is not extended beyond the building footprint to an extend more than 11 m on the side where the fire tender access is provided (*Refer Figure No. 7.10 & 7.11*).

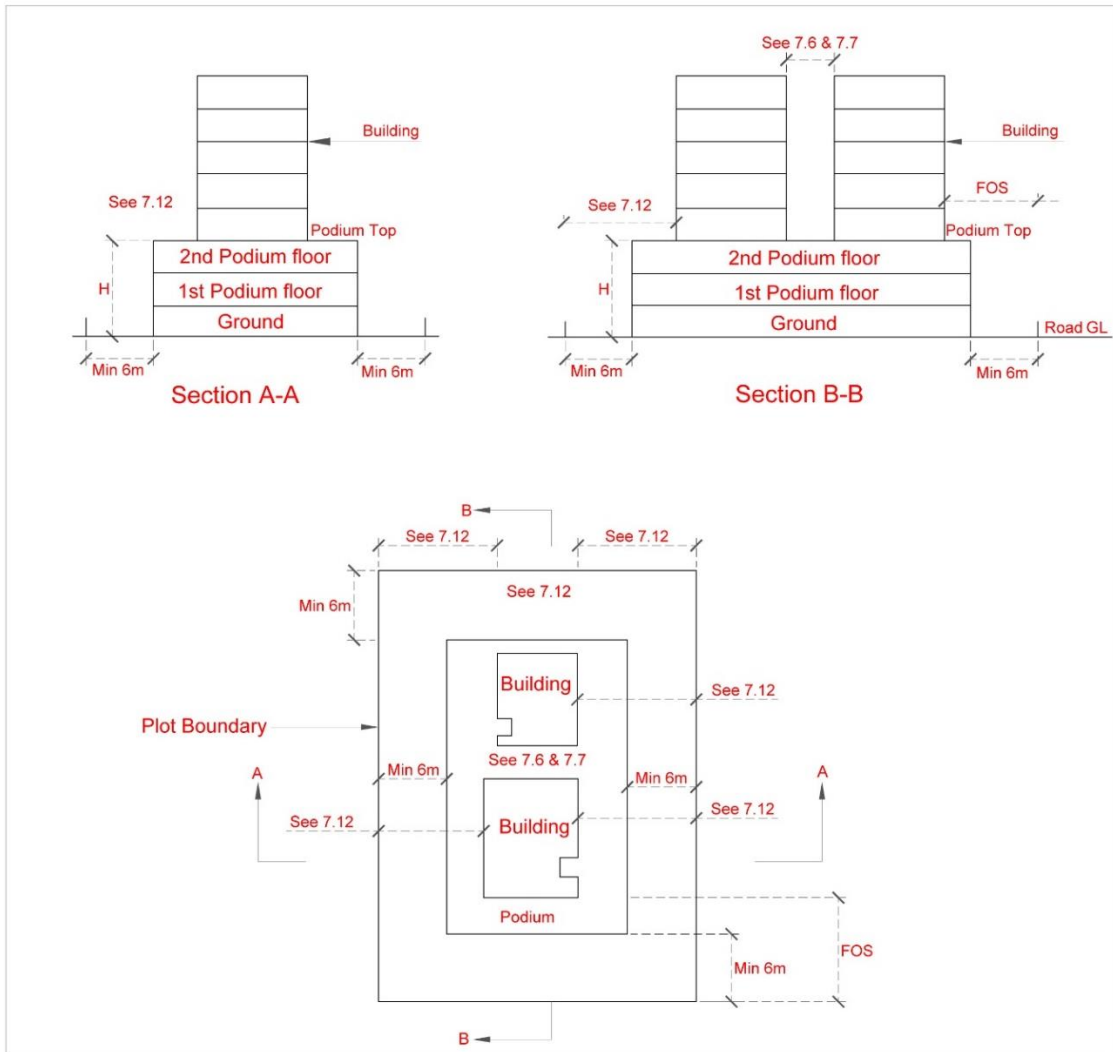

Figure No. 7.9: Building on Podium

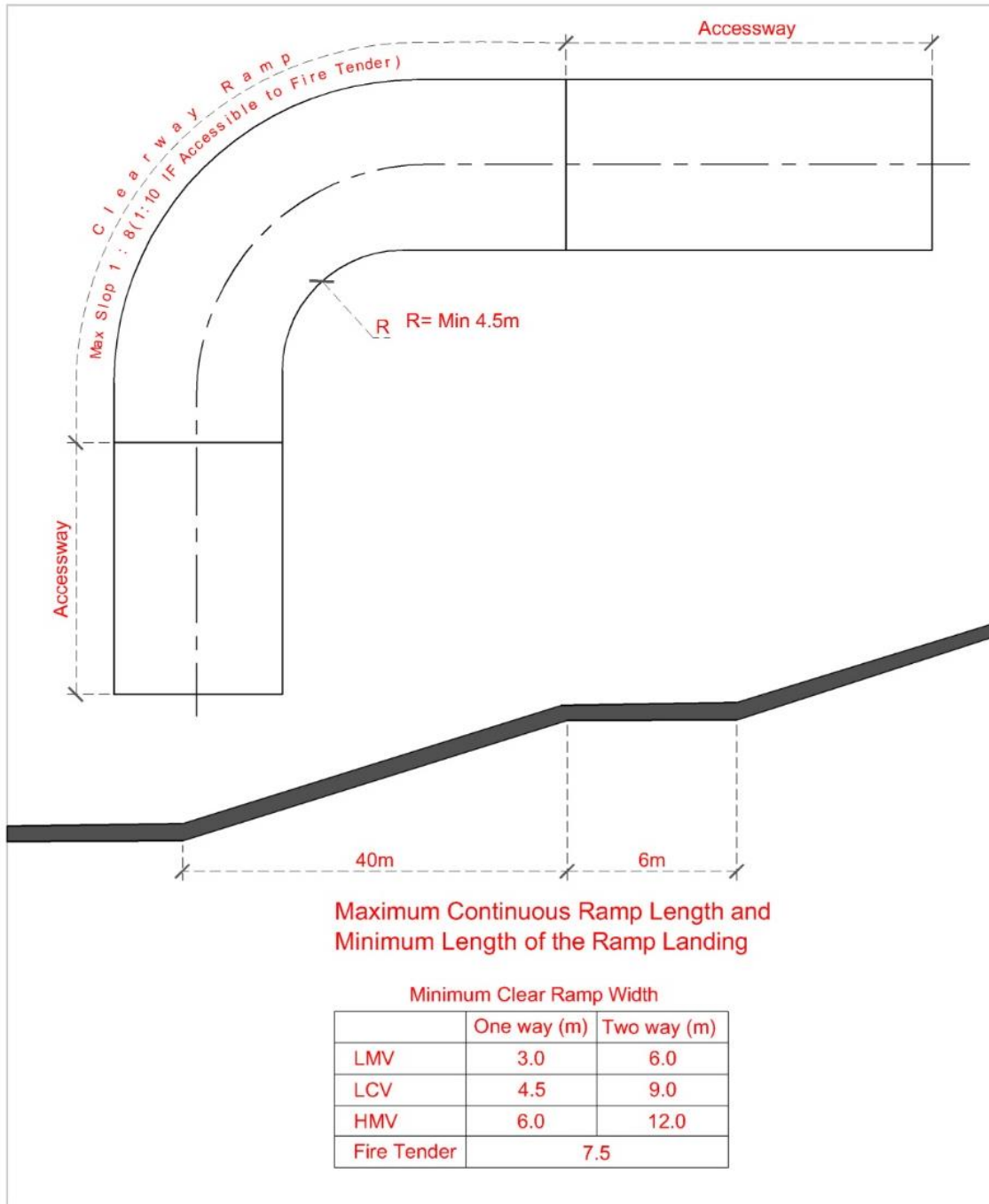

Figure No. 7.10: Ramp on Podium

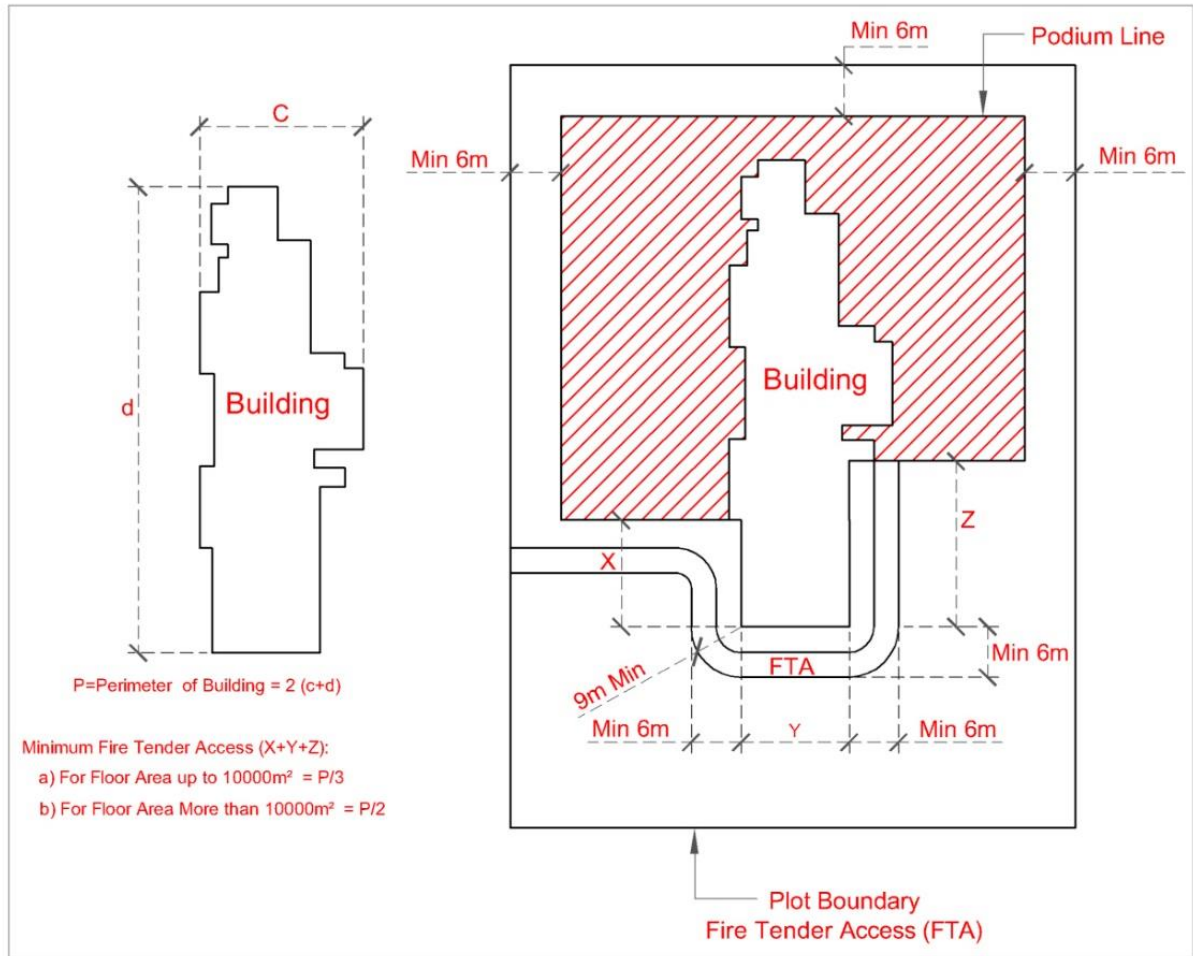

Figure No. 7.11: Emergency Vehicle Access Requirements in Case Podium is Not Accessible by Fire Tender

7.13 Parking

1 Parking space for vehicles shall be provided within the building unit for every new building and /or extension to an existing building constructed for the first use and /or when the use of old building is changed to any of the uses mentioned in the Table No. 7.17 below:

Table No. 7.17: Parking Requirements

No. (1)	Type of Use (2)	Minimum Parking Required (3)	Visitor's Parking (4)
1	Dwelling 1, Dwelling 2	1 car park for more than 100 sq m and up to 300 sq m of plinth area per unit. Additional 1 car park for every 100 sq m or part thereof of plinth area per unit. This shall be permitted within the marginal space.	Nil
	Dwelling 3	20% of utilized FSI	Additional 10%, of the required parking space shall be provided as visitors parking.
2	Mixed Use (Residential + Commercial), Mercantile 1,2 & 3, Religious, Hospitality 1, 2 & 3, Transport	Dwelling 1, 2, 3, as prescribed above. For other uses, % of utilized FSI: • 30%, if building unit size is up to 750 sq m • 40%, if building unit size is above 750 sq m and up to 2000 sq m	Residential: Additional 10%, of the required parking space shall be provided as visitors parking. Commercial:

No.	Type of Use	Minimum Parking Required	Visitor's Parking
(1)	(2)	(3)	(4)
		<ul style="list-style-type: none"> 50%, if building unit size more than 2000 sq m 	Additional 20%, of the required parking space shall be provided as visitors parking.
3	Assembly 1,2 and 3	50% of utilized FSI	Additional 20%, of the required parking space shall be provided as visitors parking.
	Assembly 4	50% of building unit area	
	Assembly – Stadium	1.25 sq m of parking area per person of the total stadium capacity	Nil
4	Health 1, 2, 3 & 4 Public Offices	50% of Total Utilized FSI For Hospitals and nursing homes, additional parking of Ambulance shall be provided at the ground level.	20%
5	Industrial- 1, 2, 3 & 4; Storage	10% of the Total Utilized FSI	Nil
6	Educational 1, 2, 3	Primary & Pre-schools- 25% of the Total Utilized FSI Secondary & Higher Secondary Schools - 40% of the Total Utilized FSI Colleges and coaching classes -40% of the Total Utilized FSI, Facility for drop-off and pick-up shall be provided within the premises. Others – 50% of the utilized FSI	10%
7	Sports and Leisure	25% of building unit Area	10%
8	Recreation 1 & 2	10% of building unit area	10%

Note: For the purposed of computing parking 'Utilised FSI' means total BUA including all exempted area from the computation of FSI.

- 2 Parking requirement for a mixed-use development shall be calculated on prorata basis of the FSI consumed specific to the different uses.
- 3 Parking is permitted at any floor level above ground and at more levels of basement as per required parking, with provision of vehicular ramp.
- 4 50% of the required visitors parking shall be provided at the ground level.
- 5 Parking area includes parking space, driveway and aisles but excludes approach road, vehicular lift, and vehicular ramps.
- 6 Parking layouts with minimum size requirements for parking space, driveways and access lanes shall be provided as prescribed.
- 7 Parking shall be permitted in side and rear margins except in Access as per Rule No. 7.7.4 (11).
- 8 Parking can be permitted in roadside margin after leaving clear margin of 4.5 m from the building boundary towards roadside at ground level only. In case a building unit abuts more than one road and has area up to 1000 sqm, it shall be permitted to utilise narrow roadside margin for parking.
- 9 Parking shall be allowed in any roadside margin for building unit having area up to 750 sqm.
- 10 Parking area should be retained as effective parking space and shall be maintained with light and ventilation system if provided in an enclosed area.
- 11 For multi-level parking, a vehicular ramp, vehicular elevator / lift shall be necessary.
- 12 If parking is provided on any upper floors with vehicular elevator, vehicular ramp is not necessary if parking space is provided with provision of floor sprinklers.
- 13 Parking shall not be permitted within an Atrium.
- 14 In case the maximum permissible FSI is not utilised, for any extension or additions in the future, additional parking as per Rules shall be provided as required for the additional utilised FSI.
- 15 Notwithstanding anything contained in Clause 7.13 (1 to 14) above, ramp, vehicular elevator / lift leading to basement or upper floors and parking at ground level shall be provided in such a

manner that 4.5 m clear stretch of space is kept for the movement of fire equipment and machineries. Provided that in case of parking to be provided in front margin as per Clause 7.13 (8) and 7.13 (9) shall be applicable.

Provided that, if ramp leads to the podium, in such cases vehicular elevator shall be permissible after keeping required margin as mentioned in podium Rule No. 7.12.

- 16 In case of stacked parking (mechanized parking) where in parking slots are provided at elevated platform, a common approach is provided to the parking below the elevated platform. The provision will be considered an equivalent to 1.5 times the area on ground, meaning if the parking space on ground/floor is 500 sq m and stacked parking is provided, it shall be considered as 750 sq m of parking space provided.
- 17 The Competent Authority may disallow parking in basement in case of flooding.
- 18 Vehicular Ramp: Connecting ground level with basement level-1 shall be permitted in side and rear margin for:
 - a) Building unit with area up to 2000 sq m or and,
 - b) Building unit with building less than and equal to 25 m in height.
- 19 Parking requirements in Core areas and Gaothans:
 - a) For Heritage structures that are identified, parking requirements shall not be required if the proposed uses are hospitality and/or sympathetic adaptive re-use to residential.
 - b) Parking spaces for vehicles shall be provided within the building unit for every new and / building or extension in existing building constructed for the first use and /or when the use of old building is changed.
 - c) Parking shall not be required in the following cases:
 - i Building unit area is less than 100 sq m and it is under residential use.
 - ii Building unit with area is less than 60 sq m and it is under non-residential use,

7.14 Open to Sky Space

Open to sky space (interior or exterior) shall be provided for natural light and ventilation in conformity with the following Rules.

7.14.1 Dimensions of Open Space

1 Core Area and Gaothan

- a) Chowk, in interior open to sky space to be provided when there is no open space on any side except front which may be the street.
For any building having depth of 9 m or more from its front margin, an open to sky space with area of 5.6 sqm with no side less than 1.8 m at plinth level shall be provided for every 9 m depth (*Refer Figure No. 7.12- Left Image*). If the width of the building is up to 4.5 m, then the size of this open to sky space shall be 3 sqm with no side less than 1.5 m (*Refer Figure No. 7.12- Middle Image*).
If the depth of the building does not exceed 18m and has openings at least on two sides over a street or open to sky space of 2.4 m or more in width, then above provision shall not be applicable (*Refer Figure No. 7.12- Right Image*).
- b) Open to Sky Space (interior / exterior)
The minimum width of any open to sky space used for light and ventilation of rooms shall be regulated as given in Table No. 7.18

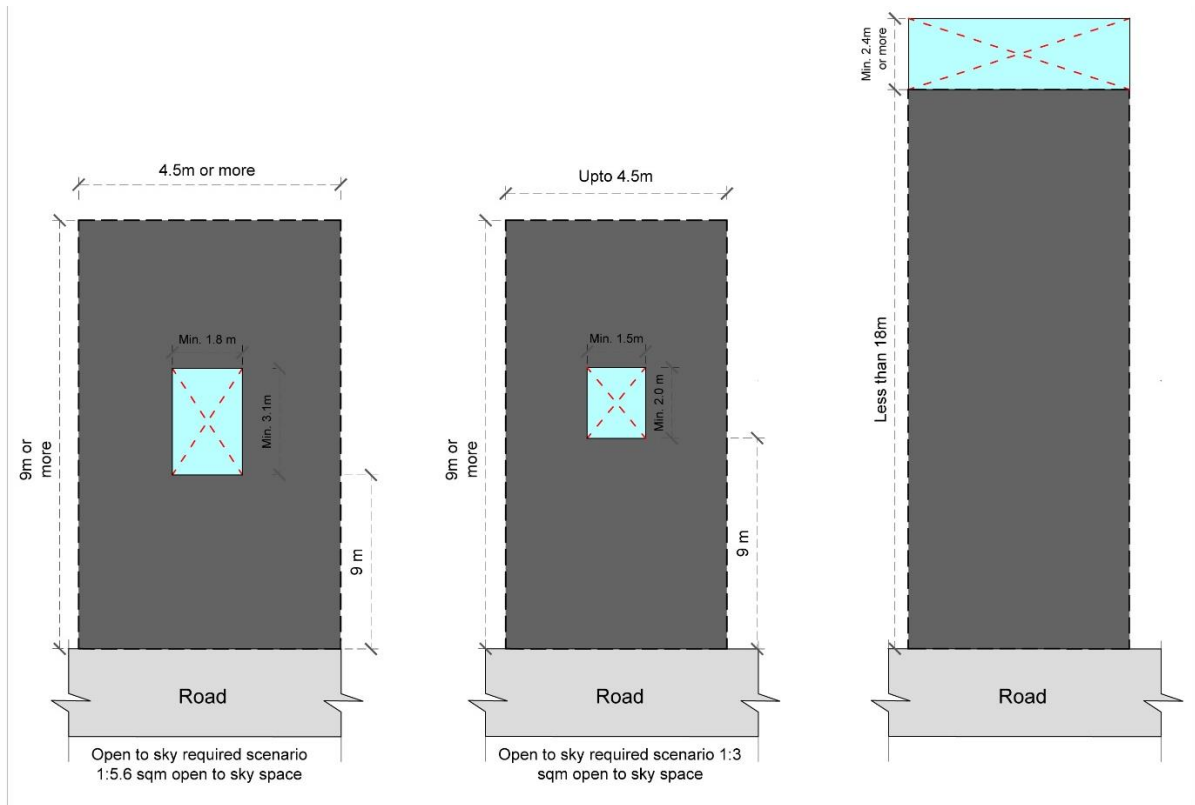

Figure No. 7.12: Open-to-Sky Space (Gamtal / Gaothan)

2 Outside Core Area and Gaothan

The minimum width of open to sky space provided in buildings at plinth and above each level shall be as under:

Table No. 7.18: Minimum Width of Open to Sky in Outside Core Area and Core & Gamtal/ Gaothan

No.	Building Height (m)	Outside Core and Gaothan (m)	Core Area and Gaothan (m)
(1)	(2)	(3)	(4)
1	Less than or equal to 10 m	3	1.5
2	Greater than 10 m and less than 16.5	4	3
3	Greater than 16.5 and less than 25	6	4
4	Greater than 25	7	5

7.14.2 Open Space next to WC and Bathroom

1 For open space next to WC and Bathroom refer Rule 13.3.4

7.14.3 General Requirements

- 1 Every such chowk / open to sky space (interior / exterior) shall be maintained for the benefit of the building and it shall be with the building unit.
- 2 Every such chowk / open space (interior / exterior) shall be provided with suitable and sufficient access.
- 3 Every such chowk / open to sky space (interior / exterior) shall be always kept free from any erection thereon and kept open to the sky.
- 4 No open drain except for rainwater shall be provided in any open space required by these Rules.
- 5 No construction work on a building shall be allowed if such work operates to reduce an open-air space of any other adjoining building belonging to the same owner to an extent less than what is prescribed by any of these Rules in force at the time of the proposed work to further reduce such open space if it is already less than what is prescribed.

7.15 Development of Land

7.15.1 Internal Road and Approach to Building and Common Plot (Refer Figure No. 7.13).

- 1 Internal Road length shall be measured from its origin to the Access Road to the building unit.
- 2 In case of single building the width of approach / internal road shall be measured based on the distance from the Town Planning Scheme or Outline Development Plan Road up to the edge of the building in case of hollow plinth, or location of the farthest entrance of a building in case of solid plinth.
- 3 In case of buildings connected internally or externally the length of internal road shall be considered up to the edge of the hollow plinth of the farthest building (in case of building with hollow plinth) and up to the location of the farthest entrance of the building in case of solid plinth.

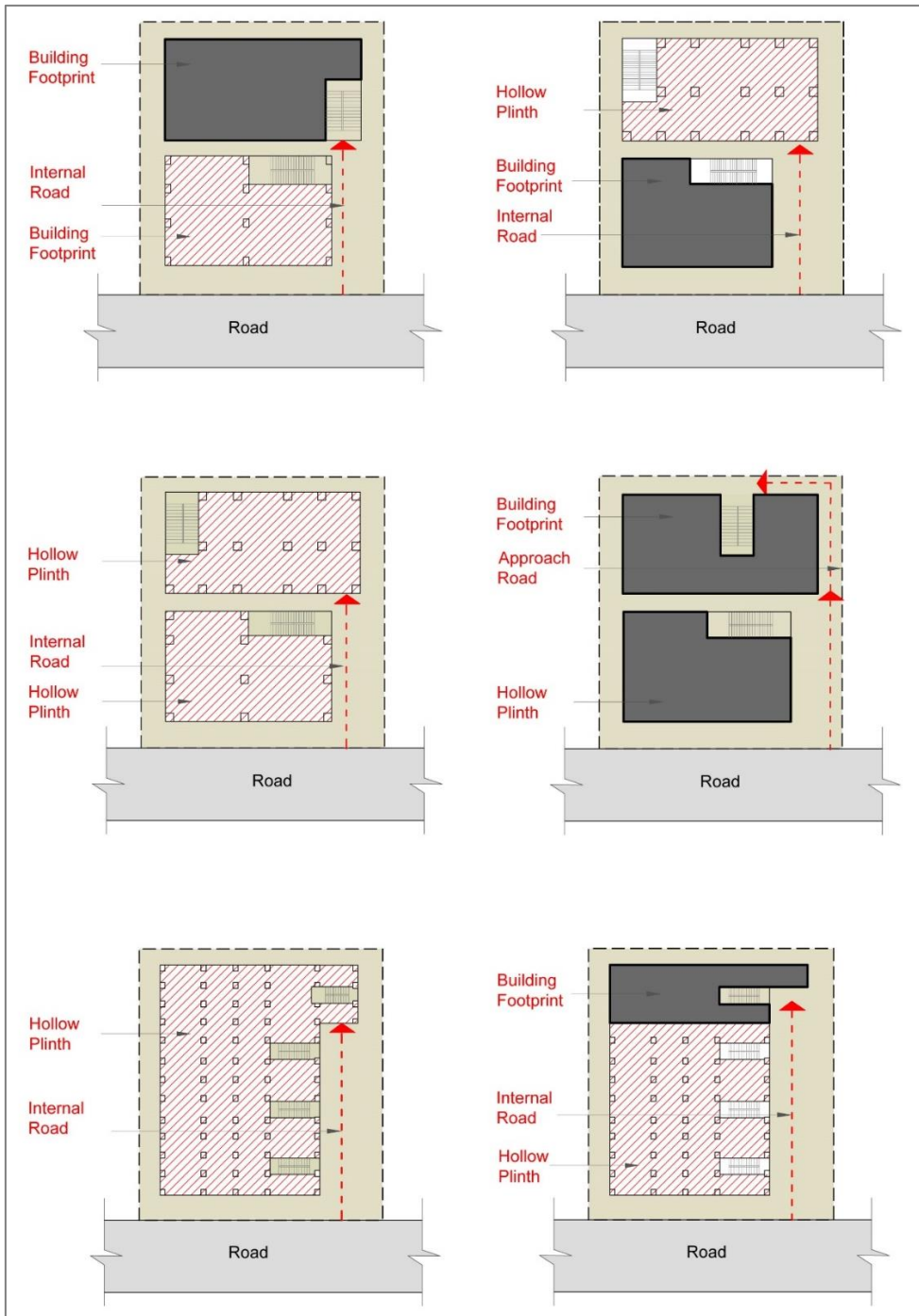

Figure No. 7.13: Internal Road and Approach to Building and Common Plot

- 4 In case of layout with two or more buildings of Dwelling 3 type dwelling units, commercial units or independent establishments, the width of Internal Road on which the building abuts shall be as applicable for a length of above 45 m category as per Table No. 7.19. In case of more than two buildings including Dwelling 1 and / or Dwelling 2 type, approach of as applicable width shall be allowed up to the second dwelling unit as per Table No. 7.19
- 5 The width of the Internal or Approach Road shall be based on the length and use of the building-unit as under:

Table No. 7.19: Provisions for the Length of Road for Layout, Sub Plotting and Building Approach

Length of road / approach in m	Width of Road / Approach (in m)					
	Layout		Sub Plotting		Building Approach (For campus planning)	
	Residential	Non-Residential	Residential	Non-Residential	Residential	Non-Residential
(1)	(2)	(3)	(4)	(5)	(6)	(7)
Upto 15 or less	6.0	6.0	3.0	4.5	3.0	4.5
Upto 45	6.0	6.0	4.5	6.0	4.5	6.0
Above 45 and upto 75	6.0	7.5	6.0	7.5	6.0	7.5
Above 75 and upto 150	7.5	9.0	7.5	9.0	7.5	9.0
Above 150 and upto 450	9.0	12.0	9.0	12.0	9.0	12.0
Above 450	12.0	15.0	12.0	15.0	12.0	15.0

Note:

- 1 Layout means the laying out of plots for the first time when land is converted from Agriculture to Non-Agriculture.
- 2 Sub Plotting means modification in the boundary of plot by sub dividing plot into more than one sub plot.
- 3 Building Approach (for campus planning) means approach given to development of a gated environment.
- 4 The length of road for calculating the width shall be considered by separating the length from junction. The length of smaller road shall be considered from the wider road.

7.15.2 General Requirements for Internal Roads

- 1 The Internal Road shall be provided up to each individual building.
- 2 Internal Road width shall be measured from the farthest point of its origin to the next wider road it meets.
- 3 In cases where the road is in continuation with any private road in the adjoining estate / plot or any public road continuous to the estate, the length of the adjoining road of the public road shall be added to the length of the internal road for the purpose of determining the width of such road.
- 4 Curves at the junction: Curvature radius shall be provided at the junction of roads as prescribed in Table No. 7.20. However, in case where approval has been granted for any building unit or a lay out plan under any Rules the Competent Authority shall not insist on these as prescribed below.

Table No. 7.20: Radius of Road Curvature Based on Width of the Road

No	Width of the Road (m)	Radius of Road Curvature (m)
(1)	(2)	(3)
1	Up to 6	3
2	More than 6 and up to 18	Half the width of the wider road whichever is higher, maximum 7.5
3	More than 18	9

Note: The width of the wider road shall be taken into consideration in determining the radius of the curvature at the junction of roads of different widths.

- 5 The shape of the plots and the junction of the roads, at the corners shall be designed as directed by the Competent Authority.
- 6 The alignment of the internal road or roads shall be regulated to be in continuation of the public or private roads continuous to the applicant's Building Unit; but in case of termination of an internal road or roads; a turning circle with diameter of 13.5 m or 12 m x 6 m turning "T" shall be required at the cul-de-sac. This requirement may be waived for such road with width of 7.5 m if the length does not exceed 110 m.
- 7 The Development Permission shall be regulated as per the proposed road network by the Competent Authority.
- 8 For development area in Non - Town Planning Area, the width of one road shall be decided by the Competent Authority.

7.15.3 Amalgamation and Subdivision of Building-Unit (Refer Figure No. 7.14)

The Owner or Developer shall be required to get the land reconstituted by the Competent Authority as 'Building unit' or 'Building units' before amalgamation or sub-division of land.

- 1 In case of subdivision or amalgamation, the depth of building unit shall be regulated as per Clause 7.15.3 (3) below.

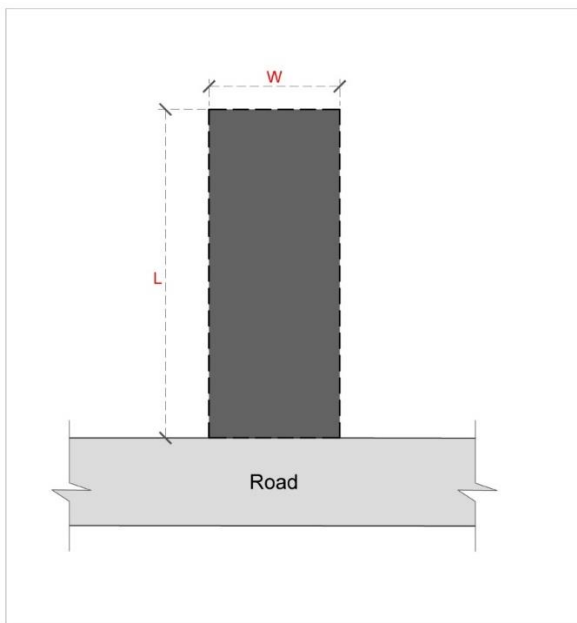

Figure No. 7.14: Amalgamation and Subdivision of Building - Unit.

- 2 Amalgamation of building unit abutting on a road with width equal or more than 18 m, shall be permitted if depth of the building unit shall not exceed three times the frontage of the building unit abutting on road.
- 3 The minimum side of the building unit shall be in accordance with its size as per Table No. 7.21.

Table No. 7.21: Minimum Side of Building Unit

No	Building Unit Area (Sq m)	Minimum Side Abutting to Road (m)
(1)	(2)	(3)
1	≤ 60	3
2	> 60 to ≤ 100	4
3	> 100 to ≤ 200	5
4	> 200 to ≤ 500	7
5	> 500	10.5

Provided that building units not in conformity to the minimum size and specified in the aforesaid table shall be exempted from the applicability of the above if they are subdivided or amalgamated prior to final notification of these Rules.

- 4 Subdivision of building unit with existing structure may be approved but such newly created subdivision shall comply with the prevailing relevant provision of General Development Rules. However, the provision of margins, for the existing building may be allowed as per the development permission granted for the existing building.

7.15.4 Contribution of Land for any Development in Non-Town Planning Scheme Areas

- 1 For any development in confirmation with zoning or use, where a Town Planning Scheme is not declared, the owner / applicant shall contribute land to the Competent Authority as under:
 - a) A minimum 12 m width of one road, considered to be a cross over road which may be determined by Authority.
 - b) Such road shall be a public road and the land falling under such road shall be part of the land contributed for infrastructure development.
- 2 Land contribution required under Clause 7.15.4 (1), may not be required in the following cases. However, for relaxing the land contribution, the Competent Authority shall record the reasons in writing and decide.
 - a) Where permission was granted for a layout and order for non-agriculture purpose, under land revenue code is passed by the Competent Authority before application / coming in force of these Rules.
 - b) Land falls in Core Area and Gamtal / Gaothan Zone.
- 3 Where a Town Planning Scheme is not prepared, the Competent Authority shall, for proper access, circulation, and mobility, prepare a road network plan. This shall be in sync with any, existing or Outline Development Plan roads.
- 4 In case of any development permission other than for agriculture use in agriculture zone, the contribution of land for amenities shall be applicable as stated in above.

7.15.5 Common Plot

- 1 Common plot is required for building unit of area 2000 sq m or above in all zones other than Agriculture zone / Preservation Zone 1 and 2 as per following Table No. 7.22:

Table No. 7.22: Minimum Common Plot Requirements (Refer Figure No. 7.15)

No.	Use	Area of the Building-Unit /Plot Size (sq m)	Minimum Required Area of Common Plot
(1)	(2)	(3)	(4)
1	Other than use mentioned in No. 2 and 3 below	≥ 2000	10 % of the area of building unit 8 % of the area of building unit in case of Core Area and Gamtal / Gaothan
2	Industrial 1, 2 & 3	≤ 5000	Nil
		> 5000 and < 20000	8 % of the area of building unit
		≥ 20000	1600 sq m + 5 % of the building unit area exceeding 20,000 sq m
3	Religious, Educational 1, 2 & 3, Health 1, 2, 3 & 4, Assembly, Public Office	≥ 2000	20% of the building unit area

- 2 For building units with area less than 2000 sq m and having buildings with height more than 25 m, a common plot shall be provided of 10% of the area of building unit or 200 sq m, whichever is more.
- 3 The common plot area shall be exclusive of approaches but can be permitted in marginal space. However, it shall not be allowed within Atrium or any covered space.
- 4 The area of the Common Plot may be sub divided such that the minimum area of the Common Plot shall be 200 sq m with no sides less than 10.0 m. In case of Affordable Housing / SPARSH 2, the Common Plot shall be provided with no sides less than 8.0 m.

- 5 Angle between adjacent sides of the Common Plot shall be 60 degrees or more.
- 6 No construction shall be permissible in the Common Plot except electric substation, transformer room, auxiliary power generator, box type transformer, section feeder pillar, meter room, over and underground water tank and pump room, security cabin, community/ society common amenities shall be allowed to be constructed in the Common Plot subject to the following requirements:
 - a) Maximum ground coverage of 15% of the respective Common Plot.
 - b) Maximum Height of construction shall be 7.5 m from the level of the building unit except in the case of overhead water tank, where more height may be permitted.
 - c) Community/ Society common facility shall be permitted on a Common Plot. The area of this Community / Society common facility built up area shall not be considered towards computation of FSI of the Building Unit. Community facilities with common plot shall be hand over to the association of allottees as the case may be as per The Real Estate (Regulation and Development) Act, 2016.
 - d) Such a building shall be required to maintain the minimum margin requirements between buildings with respect to the adjacent buildings and roadside margin as prescribed.
- 7 In case of Residential Use, 50% of the Common Plot may be allowed to be used as parking space including driveway and aisles. Parking in common plot shall be permitted in roadside margin after leaving minimum 1.5 m from the building unit boundary. This minimum 1.5m shall be utilised for shade giving trees and plantation purpose.
- 8 In case of 'all other uses except Residential Use, complete area of the Common Plot may be allowed to be used as parking space including driveway and aisles. Such parking shall be permitted in road-side margin after leaving minimum 1.5 m from the building-unit boundary. This minimum 1.5 m shall be utilised for shade giving trees and plantation purpose.
- 9 In cases where layout or subdivision of Building Unit is sanctioned with provision of required Common Plot, Common Plot shall not be insisted in case of sub-division of such sub-divided new Building-unit and/ or amalgamation of such sub-plots and/ or further development of such sub-divided new Building-unit irrespective of its area.
- 10 The Owner shall be required to give an undertaking that the Common Plot shall be used exclusively for the residents occupants of the building unit. On sanction of the Occupancy Certificate, the Common Plot shall deem to have vested in the society/association of the residents/ occupants. In case such society or Association is to be formed, the possession /custody of common plot shall remain with Developer until such association/society is formed. The Common Plot shall not be sold to any other person, and it shall not be put to any other use except for the common use of the residents /occupants.

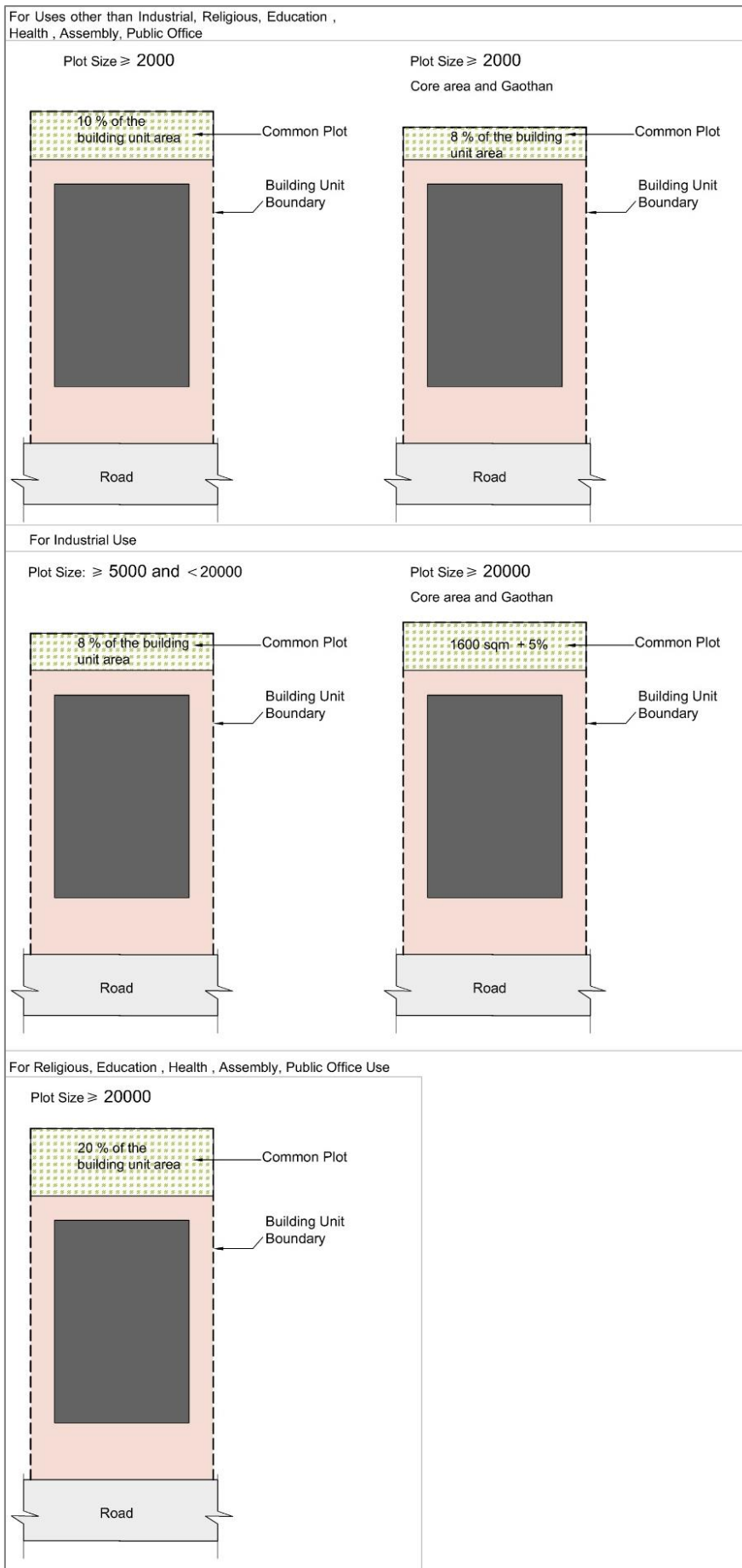

Figure No. 7.15: Common Plot

7.16 Development on Kabrastan, Burial Ground etc.

The land occupied by the graveyards, kabrastan, burial grounds, crematoria and such uses in the Outline Development Plan shall be kept permanently open. A compound wall / boundary wall can be built. Competent Authority may permit structures to be built for specific purpose.

7.17 Development on Open Space Plots

20 % of the area of the "Open Space Plots" provided under Town Planning Schemes may be utilized for the construction with required margins for common / community / public uses. Such construction shall be permitted with basement, ground floor or a floor on hollow plinth. In case the building is on hollow plinth, in addition to stair cabins and ramps, 5% of the total permissible built-up area of this plot shall be allowed to be built for the construction of storeroom, security cabin, toilet etc., at the ground level.

7.18 Heritage / Architectural Significant Areas

The Competent Authority may notify 'Heritage / Architectural Significant Areas' from time to time and frame special development Rules and Guidelines for these.

7.19 Discrepancy Removal

Any discrepancy found in the text of revenue survey number / block number / final plot number in Outline Development Plan, the Competent Authority after following the prescribed procedure of verification with Appropriate Authority for authorized revenue records / Final Town Planning Scheme records can take appropriate decision for correction of the said discrepancy in revenue survey number / block number / final plot number in Outline Development Plan, while sanctioning the Development Permission.

7.20 Development Work to be in Conformity with the Rules

All development work shall conform to the Outline Development Plan proposals and the provisions made under these Rules. Town Planning Schemes / Detailed Development Plans shall be made keeping the Outline Development Plan proposals and these Rules in view. In case Special Town Planning Schemes / Detailed Development Plans are made with a specific objective and there is a conflict between the two, in that case:

- 1 Road Network Proposals of Town Planning Scheme / Detailed Development Plan shall prevail.
- 2 Special Development Rules made for the Town Planning Scheme / Detailed Development Plan shall prevail.

8 Affordable Housing and SPARSH 2.0 Housing

The following Rules shall be applicable to development of housing for socially and economically backward section of society, low-cost housing undertaken by public agencies, cooperative societies, government / semi government bodies and registered developers. This section also includes housing under SPARSH 2.0 Notification No - LE/LI/DMN/260/SPARSH/2018/11 as amended from time to time.

8.1 Affordable Housing – Group

Other than the specific provisions below, all other Rules shall be same.

8.1.1 Applicability

Affordable Housing – Group shall be permitted all zones except Preservation Zone I, II, III and Recreational Zone I.

8.1.2 Minimum Sizes and Accommodation Requirements

- 1 In case of DW3a the maximum built up area of a dwelling unit shall not exceed 60 sq m.
- 2 For eligible complexes, upto 10% of the total utilized FSI shall be allowed for commercial uses.
- 3 The minimum accommodation provided in every dwelling unit shall be one living room, kitchen, and Bath &WC

8.1.3 Density and Floor Space Index

- 1 Minimum density for any proposed Affordable Housing shall be 225 dwelling units per hectare.
- 2 Floor Space Index (FSI) shall be regulated as under:
 - a) Base FSI shall be available as per relevant zone. Minimum permissible base FSI must be consumed to qualify as affordable housing. Additional FSI shall be charged as specified in Table No. 8.1.
 - b) Areas under staircase, passages and corridors shall be exempt from the computation of FSI.

Table No. 8.1: Chargeable FSI for Affordable Housing Dwelling

No.	Residential Dwelling Units Built-up Area (sq m)	Additional FSI Charge
(1)	(2)	(3)
1	up to 30	30% of Circle Rates
2	more than 30 and up to 40	40% of Circle Rates
3	more than 40 and up to 50	50% of Circle Rates
4	Commercial Built-up area	60% of the Circle Rates

8.1.4 Common Plot

Common plot for affordable housing shall be provided at 10% of the building unit area for building units 2000 sq m and above. Smaller common open plots may be provided spread within the plot.

8.1.5 Parking

- 1 Parking space for vehicles shall be provided as specified in Table No. 8.2

Table No. 8.2: Parking Norms for Affordable Housing

No.	Type of Use	Minimum Parking Required	Visitor's Parking
(1)	(2)	(3)	(4)
1	Affordable Residential Apartments with dwelling units of built-up area up to 30 sq m	10% of utilized FSI	Additional 10% of the required parking space shall be provided as Visitors parking.

No.	Type of Use	Minimum Parking Required	Visitor's Parking
(1)	(2)	(3)	(4)
2	Affordable Residential Apartments with dwelling units of built-up area more than 30 sq m	15% of utilized FSI	Additional 10% of the required parking space shall be provided as Visitors parking.
3	Commercial Use	50% of utilized FSI	Additional 20% of the required parking shall be provided as Visitors parking.

Note: For the purpose of computing parking 'Utilised FSI' means total BUA including all exempted area from the computation of FSI.

- 2 In case the maximum permissible FSI is not utilized, for any extension or addition in the future, additional parking shall have to be provided as required for this additional utilized FSI.
- 3 Rest of the parking requirements shall conform to provisions of Rule No. 7.13.

8.2 Affordable Housing – Plotted

8.2.1 Applicability

Affordable Housing – Plotted shall be permitted all zones except Preservation Zone I, II, III and Recreational Zone I.

8.2.2 Minimum Sizes and Accommodation Requirements

- 1 In case of DW1a and DW2a, the minimum, and the maximum plot size shall be between 25 sq m and 40 sq m.
- 2 The minimum frontage of plot shall be 3 m in width.
- 3 At every 20 such continuous plots 2 m wide spaces open to sky shall be provided.
- 4 The minimum accommodation provided in every dwelling unit shall be one living room and a WC where there is a drainage system; the agency developing the area shall install and maintain the internal drainage system, where there is no drainage system the individual soak-pit shall be provided as per provision of National Building Code.
- 5 The maximum number of stories in a building construction on the plot shall be ground plus one upper storey only.

8.2.3 Density

- 1 Minimum density for any proposed Affordable Housing shall be 225 dwelling units per hectare.

8.2.4 Common Plot

Common plot for affordable housing shall be provided at 10% of the building unit area for building units 2000 sq m and above. Smaller common open plots may be provided spread within the plot.

8.2.5 General Building Requirements

- 1 The minimum height of the plinth shall be 30 cm from the top surface of approach road or pathway.
- 2 Room sizes:
 - a) The size of living room, bedroom shall not be less than 8 sqm with minimum width of 2.4 m
 - b) The size of independent bathroom and WC shall be 0.9 sqm with minimum width of 0.9 m each. The size of combined bathroom and WC shall be 1.8 sqm with minimum width of 1m.
- 3 Room heights:

Minimum heights of rooms shall be as under:

Living room-	2.4 m
Kitchen	2.4 m

Bath/WC-	2.1 m
Corridor-	2.1 m

In case of the slopping roof the average height of thereof shall be 2.4 m and the minimum height of the eaves shall be 2.1 m.

The minimum slopes of the slopping roof shall be 30 degree for G.I sheets, asbestos sheets or tiled roof while for R.C.C sloping roof, the minimum slop shall be 12 degree.

- 4 The opening through windows, ventilators, and other opening for light and ventilation shall
 - a) One tenth of the room floor area.
 - b) For WC and bath not less than 0.2 sq m
- 5 Stairs
 - a) The width of staircase shall be 0.75m minimum, the maximum height of the riser shall be 20 cm. The minimum width of the tread shall be 22.5 cm.
 - b) The minimum clear head roof of the staircase shall be 2.10 m.
 - c) There shall be one staircase for every 12 (twelve) dwelling units or part thereof.

8.2.6 Structural Requirements

- 1 Load bearing walls of the building shall be of Brick stone or pre-cast block in any mortar, in the case of R.C.C framed structure or wooden framed structure filler walls may be of suitable local materials.
- 2 Roof of the building shall be of galvanized iron sheets, asbestos sheet, tiles roof or RCC roof .in the case of upper storied buildings middle floor shall be of wooden or RCC and rest as per choice.
- 3 Doors and windows of building shall be of any material.
- 4 Rest of the work of building shall be as per locally available resources and as per choice.
- 5 For structural safety and services Rules 16.2 and 16.7 shall be applicable.

8.3 SPARSH 2.0 Housing

8.3.1 Applicability

SPARSH 2.0 Housing shall be permitted all zones except Preservation Zone I, II, III and Recreational Zone I, II. It shall be notified the vide Notification No. LE/LI/DMN/SPARSH/2018/11

8.3.2 Minimum Required Accommodation

- 1 In case of DW3s, one dwelling unit of the complex should not be less than 30 sq m (322 sq ft). Moreover, more than 33 % of the dwelling units of the complex should be more than 32.5 sq m (350 sq ft)
- 2 For eligible complexes, upto 10% of the total utilized FSI shall be allowed for commercial uses.
- 3 Each dwelling unit should at least two rooms and a separate toilet, bathroom and either a separate kitchen for each room or a common kitchen for the entire housing complex.
- 4 Each dwelling unit should be properly ventilated.
- 5 If the dwelling unit is being used as a dormitory, the dwelling unit shall not contain more than 1 bed per 5.10 sq m (55 sq ft)
- 6 Each dwelling unit (DU) should have a dedicated water supply.
- 7 The housing complex should have solar panels and common areas should have free of cost lighting for all residents.
- 8 The housing complex should have septic tank or soak pit of size not less than 105 liters X 5 X the number of dwelling units X 2 or as CPHEO norms, whichever is higher.
- 9 The developer should agree to either sell or rent for atleast 20 years, a minimum of 66% of the dwelling units, rounded to the lowest integer, to the Economically Weaker Section.
- 10 The responsibility for maintenance of the housing complex, including the collection of waste in twin bins etc., shall be of the owner of the housing complex.

8.3.3 Floor Space Index

- 1 Floor Space Index (FSI) shall be regulated as under:

- a) Base FSI shall be available as per relevant zone. Minimum permissible base FSI must be consumed to qualify as SPARSH 2.0 Housing.
- b) Additional 50% of the permissible base subject to utilisation of maximum permissible FSI of the zone shall be available for the developer free of charge.
- c) No TDR and chargeable FSI shall be available.

8.3.4 Margins

The roadside margins shall be as per Rule No. 7.7.1. The side and rear margins are based on plot sizes and shall be as under:

Table No. 8.3: Plot Area and Minimum Margins

Land Use	Plot Area (sq m)	Minimum Setback (m)	
		Rear	Sides
Residential Use	Up to 100	1.50	Nil
	101 to 200	2.00	Nil
	201 to 400	2.50	1.50
	401 to 600	2.50	2.50
	601 to 2000	3.00	3.00
	2001 to 5000	5.00	5.00
	5001 to 10000	9.00	5.50
	Above 10001	10.50	5.50

8.3.5 Common Plot

Common plot shall be provided at 10% of the building unit area for building units 2000 sq m and above. Common plot may be provided in a manner that atleast one portion / part shall have an area of 200 sq m with no side less than 8 m.

8.3.6 Parking

No Parking spaces shall be required for housing under Scheme for Promotion of Affordable Rental Smart Housing (SPARSH)/ Affordable Rental Housing Complexes (ARHCs)/ Affordable Housing in Partnership (AHP)/ Low-Cost Housing Complexes for EWS.

9 Mining, Quarrying and Brick Kiln

The following regulations shall govern Mining, Quarrying and Brick Kiln operations and shall form conditions for development permission:

- 1 Any mining, quarrying and brick kiln operations without any blasting shall be permitted within a distance of 75 m from the boundary of any public road, railway line, canal, transmission line or any other building.
- 2 Mining, quarrying and brick kiln operations which involves blasting shall not be permitted within a distance of 200 m from any public road, railway line, canal, transmission line or any other building.
- 3 No building operations shall be permitted on the plot on which mining and quarrying, and brick kiln operations have been permitted, without the prior approval of the Competent Authority
- 4 The mining, quarrying and brick kiln shall be permitted for a stipulated period not exceeding three years from the date of development permission at a time and shall be so prescribed in the development permission.
- 5 The mining, quarrying and brick kiln operations shall not cause any nuisance to people in the vicinity.
- 6 The mining, quarrying and brick kiln operations below the average ground level shall be permitted only for the extraction.
- 7 For brick kiln, every manufacturer of clay bricks, tiles or blocks shall use at least 25% of fly ash.

10 Fuelling Station

Building units for use as Fuelling Station shall comply with Petroleum Rules 1976 under the Petroleum Act 1934.

10.1 Location

- 1 Fuelling Stations may be permitted on road width of 18 m and above in any Zone except Preservation Zone I and II.
- 2 The location of fuelling station with Service Station shall be at a distance of 50 m, away from the junction of two or more roads, if one of the roads is 18m and above in width and it shall be 30 m away from the junction, if the roads are less than 18 m in width. The minimum distance shall be computed from the boundary of the building unit to the junction (*Refer Figure No. 10.1*).
- 3 In the case the Service Station is provided along a main road which has a service road or a margin access road, the access to the Service Station should be provided from the service road or the margin access road and not from the main road.

10.2 Maximum Permissible Ground Coverage

The maximum permissible ground coverage for Fuelling Station with and without service station, shall be 45% of the building unit including the area of the canopy.

10.3 Margins

10.3.1 For Fuelling Station without Service Station (*Refer Figure No. 10.2*).

- 1 Roadside margin from canopy to the building unit boundary shall be as per Rule 7.7 subject to minimum 6 m. On all other sides, margin from canopy to the building unit boundary shall be 4.5 m and 6 m in the case of canopy having up to 6 m and more than 6 m from the ground respectively.
- 2 Marginal distance from curb site (Fuelling) to the building unit boundary abutting the road shall be minimum 9 m and for other sides, it shall be 6 m.
- 3 Administration building shall have minimum roadside margin as per Rule 7.7 and minimum side and rear margins of 4.5 m and as per Rule 7.7. Zero margins can be provided towards canopy, but minimum 6 m clear driveway shall be provided along curb site.
- 4 Minimum 6 m clear driveway shall be maintained along the curb site (Fuelling).
- 5 Minimum width of access road shall be 6 m.

10.3.2 For Fuelling Station with Service Station (*Refer Figure No. 10.3*).

- 1 Roadside margin from canopy to the building unit boundary shall be as per Rule 7.7 subject to minimum 6 m and all other sides shall be 6 m.
- 2 Marginal distance from curb site (Fuelling) to the building unit boundary abutting the road shall be minimum 9 m and for other sides, it shall be 6 m.
- 3 Administration building shall have minimum roadside margin as per Rule 7.7 and minimum side and rear margins of 4.5 m and as per Rule 7.7. Zero margins can be provided towards canopy, but minimum 6 m clear driveway shall be provided along curb site.
- 4 Service station building shall maintain a minimum roadside margin of 6 m and minimum side and rear margins of 4.5 m. Zero margins can be provided towards canopy, but minimum 6.0 m clear driveway shall be provided along curb site and 3 m towards other sides of the plot.
- 5 Minimum 6 m clear driveway shall be maintained along the curb site (Fuelling).
- 6 Minimum width of access road shall be 6 m.

10.4 Height, Floor Space Index and Common Plot

- 1 The maximum allowable height of the canopy shall be 7.5 m and administration / service station building shall be 10 m.
- 2 FSI shall be according to the relevant zone. In case the permissible FSI is not consumed, there shall be no compensation.
- 3 Common plot shall not be required.

10.5 Parking

Every fuelling Station without and with Service Station should provide minimum parking spaces based on the building unit area as given in Table No. 10.1 below:

Table No. 10.1: Minimum Parking for Fuelling Station

No (1)	Fuelling (Sq m) (2)	Minimum Parking Requirement (3)
1	600 to less than 1200	3 cars and 5 two-wheelers
2	1200 and above	For every 500 sq m or part thereof more than 1000 sq m area of building unit, additional parking for 1 car and 2 two-wheelers shall be provided.

10.6 Basement

No basement shall be allowed. Underground fuel tanks are allowed.

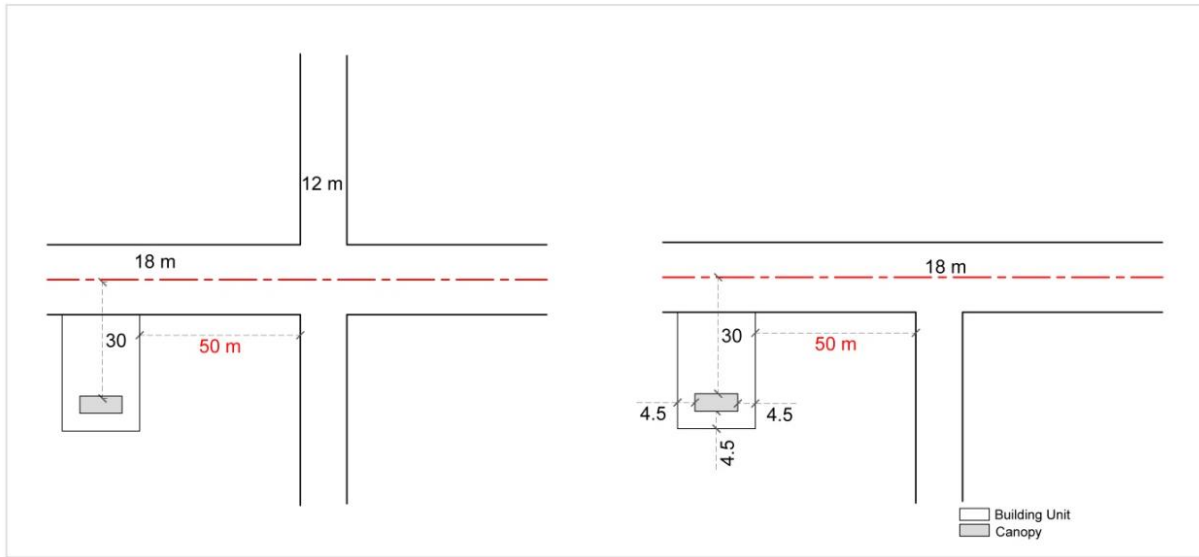

Figure No. 10.1: Minimum Distance from the Junction.

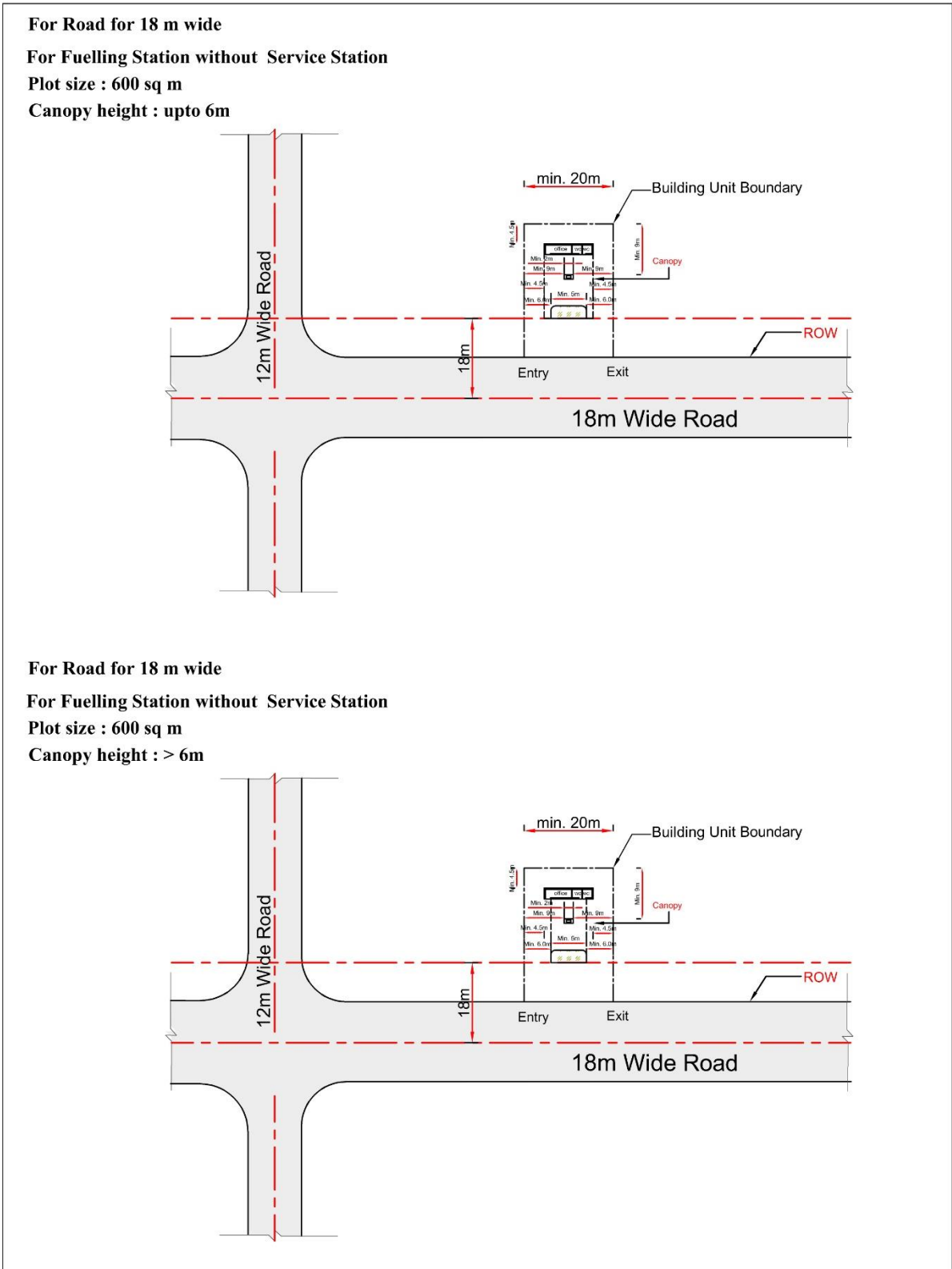

Figure No. 10.2 Minimum Margin for Fuelling Station without Service Station

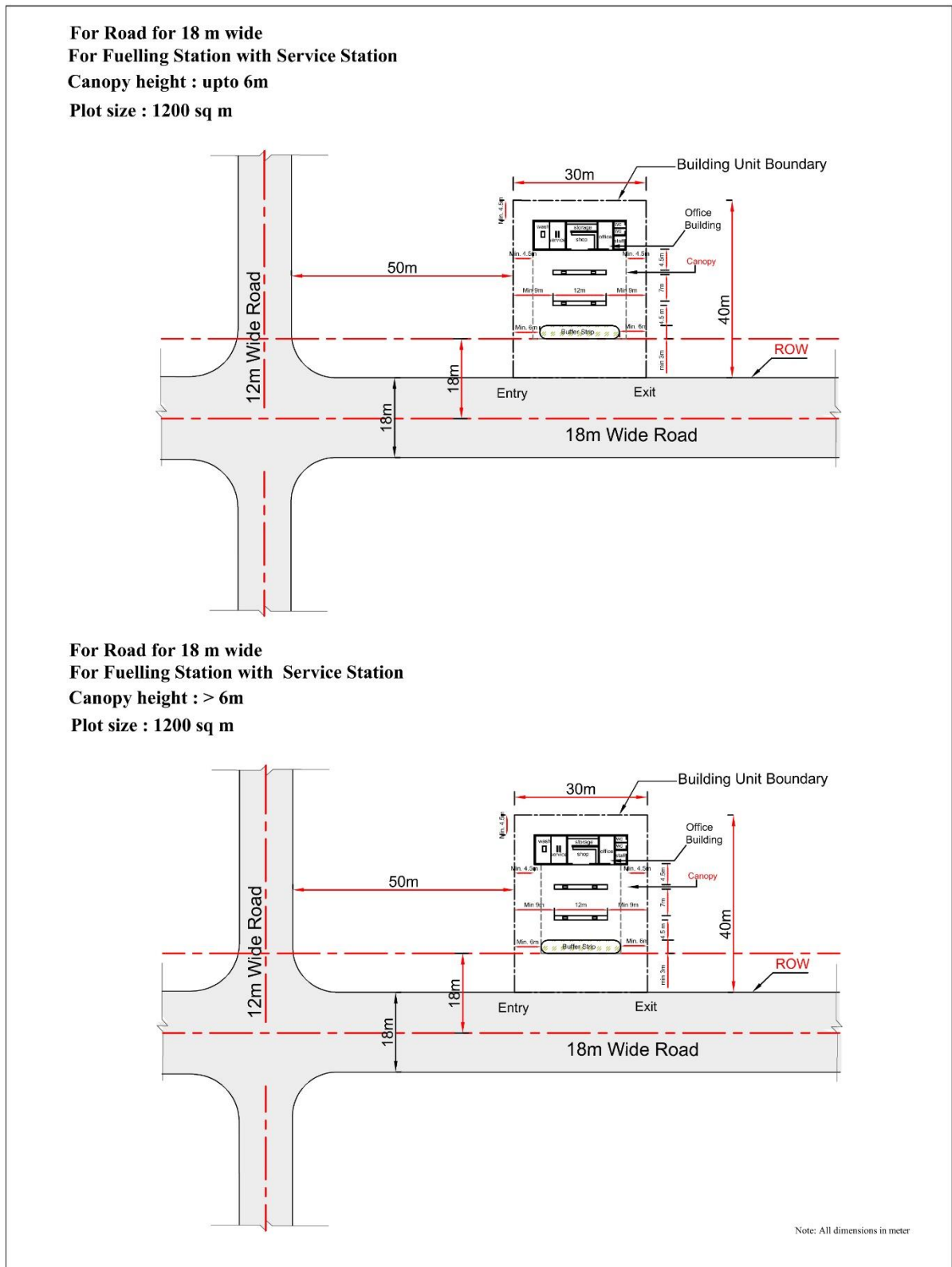

Figure No. 10.3 Minimum Margin for Fuelling Station with Service Station

11 Electric Vehicle (eV) Charging Station

Building units for use as eV Charging Stations shall comply with electric charging station established under Charging Infrastructure for Electric Vehicles- Guidelines and Standards notified by Ministry of Power, dated 2018 (Amended 14 January 2022).

- 1 Owners may charge their Electric Vehicles at their residences (DW1 and DW2) using their existing electricity connections.
- 2 For all DW3 residential dwellings, 10% of the parking area provided (either on ground / stilt / basement) must be equipped with Type 2 connector charging points OR have atleast one charging point that is equipped with Type 2 connector.
- 3 For all Mercantile 2, Education 2 & 3, Assembly 1, 2, 3 & 4, Hospitality 1, 2 & 3, Service Establishment 2, and Industrial 1, 2 and 3, 10% of the parking area provided must be equipped with Type connector charging points.
- 4 Any individual/entity is free to set up public charging stations provided that, such stations meet the technical, safety as well as performance standards and protocols laid down below as well as norms / standards / specifications laid down by Ministry of Power, Bureau of Energy Efficiency (BEE) and Central Electricity Authority (CEA) from time to time.

In an urban area / PDA area such a PCS can be set up on a 12 m and above road in any zone except Preservation Zone I, II and III.

Along the NH / SH they can be set up at every 25 km distance on both sides of the road.

12 Advertising Display and Communication Infrastructure

12.1 Outdoor Advertising Display Infrastructure

Permission shall be required for any nature of **outdoor** advertising display infrastructure or communication infrastructure / telecommunication infrastructure / microwave communication tower as per Schedule No. 11 (other than sign boards for wayfinding). This is applicable for but not limited to billboards with liquid crystal display board (LCD), light emitting diodes (LED), kiosks, wall Signs, glass display, vehicles (non-motorized and motorized etc.), floating balloons and digital display.

12.1.1 Billboards / Hoardings in Margin Space

- 1 One billboard / hoarding is permitted in the marginal open space up to 500 sq m area of the building unit. Up to a maximum of two billboards / hoardings per building unit shall be permitted in the marginal open space in building unit above 500 sq m.
- 2 The billboards / hoardings shall be permitted in the margin open space of the building unit as per Table No. 12.1.
- 3 Lighting may extend beyond the stipulated maximum height of, for the billboards / hoardings erected on ground.

Table No. 12.1: Billboards / Hoardings in Margin Space

Location	Road Width (m)	Maximum Billboard / Hoarding Size (width x height) (m x m)	Minimum Margin Roadside (m)	Minimum Ground Clearance (m)	Max. Height (m)
(1)	(2)	(3)	(4)	(5)	(6)
Margin Open Space	Upto 60	9.0 x 4.5	0.6	3.0	16.5
	Above 60	12.0 x 6.0	1.5	3.0	16.5

12.1.2 Billboards / Hoardings on Roof tops / Terrace

- 1 Maximum permissible height of the billboard / hoarding shall be considered over and above the permissible/ existing height of the building.
- 2 No roof top billboards / hoardings shall extend beyond the building line of the building on which it is erected, nor shall it extend beyond the roof in any direction.
- 3 Lighting may extend beyond the stipulated maximum height of, for the billboards / hoardings within the building unit.
- 4 The billboards / Hoardings on roof tops and terrace shall be permitted and shall be regulated as per Table No. 12.2.
- 5 Billboards on roof tops are not permitted unless the entire roof is constructed with non-combustible materials

Table No. 12.2: Billboards / Hoardings on Roof Tops / Terrace

Location	Road Width (m)	Maximum Billboard/ Hoarding Size (width x height) (m x m)	Max. no. of billboard / hoarding	Minimum Margin (m)		Maximum Height from top of Terrace (m)
				Parapet	Between two Billboards	
(1)	(2)	(3)	(4)	(5)	(6)	(7)
On Roof Tops / Terrace	Upto 60	12.0 x 6.0	2 (different facing directions)	1.5 m	1.5	7.5
	Above 60	18.0 x 9.0				10.5

12.1.3 Billboards / Hoardings on Public Roads

- 1 The Billboards / Hoardings on Public Roads shall be permitted and shall be regulated as per Table 12.3.
- 2 The Competent Authority may allow /disallow billboards / hoardings having exceptional size on specific locations considering safety aspects and for which it shall record reasons in writing.

Table No.12.3: Billboards / Hoardings on Public Roads

No	Road Width (m)	Minimum Ground Clearance (m)	Permissible Size of the Billboard /Hoarding (width x height) (m x m)
(1)	(2)	(3)	(4)
1	Upto 60	3.0	9.0 x 4.5
2	Above 60	3.0	12.0 x 6.0

12.1.4 Billboards in Urban Renewal Project Areas

These billboards must confirm with these Rules and with the Local Area Plan / Comprehensive Development Plan or special restrictions for the area, which may include additional regulations or requirements.

12.1.5 Heritage Buildings and Precincts

The Competent Authority can deny the permission on the grounds of protecting the ambience of heritage buildings and precincts.

12.1.6 General Restrictions

Billboards / hoardings will be restricted under the following conditions:

- 1 Any billboard / hoarding which may obstruct the vision required for safe traffic movement.
- 2 Any billboard / hoarding which in the opinion of the Competent Authority is likely to be confused with authorized traffic signs or signals.
- 3 Any billboard / hoarding contains the word "Stop", "Look", "Danger" or other similar words that might mislead or confuse the travellers.
- 4 Any billboard / hoarding that is attached to or printed on a rock or other natural objects.
- 5 Any billboard / hoarding that is prohibited or restricted for the purpose of public appearance under local or state or national law.
- 6 Any billboard / hoarding with overhang over public property which obstructs access or egress from any building.
- 7 Any billboard / hoarding containing unfair, vulgar matter or advertisement that is considered objectionable in Competent Authority's opinion shall not be permitted. Advertisements that are prohibited by the Government shall not be permitted.
- 8 Billboard / hoarding, its structure or lighting that is projecting outside the boundary of the building unit.

12.2 Communication Infrastructure / Telecommunication Infrastructure / Microwave Communication Tower

Provisions shall apply for communication infrastructures such as Post & Telegraph, Telephone, Wireless, Broadcasting, Cellular Mobiles, Internet, 'V' Set, ATM, Channel Discs and Overhead lines (for telephone, digital connections for internet and channels and other similar forms of communication).

The communication infrastructure shall be either placed on the building roof tops or terraces at a distance of minimum 1.5 m from the parapet or on the ground or open space within the premises subject to other Regulations.

Part C Performance Rules

Part C Performance Rules

13 Building and Infrastructure

13.1 Architectural Elements

- 13.1.1 Boundary Wall Compound Wall and Gate
- 13.1.2 Level of Building Unit
- 13.1.3 Paving in Building Unit
- 13.1.4 Access
- 13.1.5 Plinth
- 13.1.6 Entrance
- 13.1.7 Minimum Clear Heights in Buildings
- 13.1.8 Mezzanine
- 13.1.9 Loft
- 13.1.10 Railings / Parapet
- 13.1.11 Terrace
- 13.1.12 Staircases, Corridors and Passageway
- 13.1.13 Ramp
- 13.1.14 Façade Maintenance Requirement

13.2 Parking

- 13.2.1 Parking to be Provided.
- 13.2.2 Parking layout Specifications for Cars
- 13.2.3 Parking Layout Specifications for Two Wheelers
- 13.2.4 Parking Layout Specifications for Trucks
- 13.2.5 Specified Parking for Loading and Unloading

13.3 Lighting and Ventilation

- 13.3.1 Lighting and Ventilation of Rooms
- 13.3.2 Ventilation of Basement
- 13.3.3 Ventilation of Atrium
- 13.3.4 Ventilation of Bathrooms and Water Closets
- 13.3.5 Ventilation of Staircase for Dwelling 1 and 2
- 13.3.6 Ventilation of Industrial Building
- 13.3.7 Ventilation of Special Building
- 13.3.8 Change of Ventilation System

13.4 Heating and Air Conditioning

- 13.4.1 Air Conditioning of Special Building

13.5 Water Supply Requirements

- 13.5.1 Water Storage Tank
- 13.5.2 Drinking Water Supply

13.6 Building Signage

13.7 Letter Box

13.8 Sanitation

- 13.8.1 For Residential Buildings
- 13.8.2 For all Buildings other than Residential
- 13.8.3 For Special Buildings

13.9 Drainage

13.10 Electrical Infrastructure

13.11 Digital Communication Infrastructure

- 13.11.1 Solutions for In-Buildings and Gated Buildings
- 13.11.2 Provisions at layout Level
- 13.11.3 Provision of In Building Solutions Components (as per NBC 2016)
- 13.11.4 Process for obtaining IBS-NOC for Development permission and Occupancy Certificate

13.12 Lifts and Elevators

13.12.1 For buildings exceeding 4 m height with following uses: Public Offices, Assembly, Educational 2, 3

13.12.2 For buildings exceeding 10m height.

13.12.3 General Requirements for Lifts and Elevators

13.13 External Facade

13.14 Occupant Load

14 Fire Rules (See Part 3 (II))

(Only contents are listed here, the Rules are in Part 3 (II)).

14.1 General

14.1.1 Scope

14.1.2 Definitions

14.1.3 Procedure for Clearance from Fire and Emergency Services for Development Permission and Occupancy Certificate

14.1.4 Renewal of Fire Clearance

14.1.5 Fee

14.1.6 Penalties

14.2 Fire Prevention

14.2.1 Classification of Buildings Based on Occupancy

14.2.2 Fire Divisions

14.2.3 Types of Building Construction

14.2.4 General Requirements of All individual Occupancies

14.3 Life Safety

14.3.1 General

14.3.2 General Exit Requirements

14.3.3 Occupant Load

14.3.4 Egress Components

14.3.5 Compartmentation

14.3.6 Smoke Control

14.3.7 Gas Supply

14.3.8 Hazardous Areas, Gaseous, Oil Storage Yard, etc

14.3.9 Fire Detection and Alarm

14.3.10 Fire Officer

14.3.11 Fire Drills and Fire Orders

14.4 Fire Protection

14.4.1 Fire Extinguishers/ Fixed Firefighting Installations

14.4.2 Fire Detection and Alarm System

14.5 Additional Occupancy wise Requirements

14.5.1 Residential Buildings (Group A)

14.5.2 Hospitality Buildings (Group B)

14.5.3 Educational Buildings (Group C)

14.5.4 Health and Public Buildings (Group D)

14.5.5 Assembly Buildings (Group E)

14.5.6 Transportation (Group F)

14.5.7 Storage Buildings (Group G)

14.5.8 Mercantile Buildings (Group H)

14.5.9 Business Buildings (Group I)

14.5.10 Industrial Buildings (Group J)

15 Special Buildings Performance Rules

15.1 Visibility

15.2 Mixed Occupancy

15.3 Public Offices / Hospital Buildings

15.4 Public Safety

16 Structural Safety

- 16.1 Applicability
- 16.2 Structural Stability and Maintenance of Existing Buildings
- 16.3 Additions and Alterations to Existing Buildings
- 16.4 Change of Use of Building or Part of a Building
- 16.5 Structural Safety Provision during Construction
- 16.6 Structural Safety Tests for Special Buildings
- 16.7 Design for Structural and Seismic Safety
 - 16.7.1 Design Standards
 - 16.7.2 Structural Inspection Report
- 16.8 Structural Safety of Display Structure

17 Environmental Management / Sustainability

- 17.1 Minimum Distance from Water Body and Water Course
- 17.2 Rainwater Management
 - 17.2.1 Rainwater Disposal
 - 17.2.2 Rainwater Harvesting
 - 17.2.3 Open Spaces within Layouts
 - 17.2.4 Public Open Spaces
- 17.3 Solid Waste Management
 - 17.3.1 Solid Waste Bin for Residential Use
 - 17.3.2 Solid Waste Bin for Non-Residential Use
- 17.4 Grey Water Recycling
 - 17.4.1 Applicability
 - 17.4.3 Provisions of Recycling System
 - 17.4.4 Quality of Water and Treatment
 - 17.4.5 General Provisions
 - 17.4.6 Enforcement of Rules
- 17.5 Tree Plantation
- 17.6 Solar Energy Systems
 - 17.6.1 Solar Water Heating System
 - 17.6.2 Roof Top Solar Energy Installations and Generation
- 17.7 Energy Efficient Buildings
- 17.8 Energy Conservation Code Compliant Buildings
- 17.9 Environment Impact Assessment

18 Pollution Control

- 18.1 Air Pollution
- 18.2 Water Pollution
- 18.3 Noise Pollution
- 18.4 Industrial Pollution

19 Maintenance and Upgradation

- 19.1 Maintenance of Buildings
 - 19.1.1 Responsibility for Maintenance of Buildings
 - 19.1.2 Periodic Inspection and Maintenance Certificate
- 19.2 Maintenance of Lifts and Escalators
 - 19.2.1 Responsibility for Maintenance of Lift and Escalators
 - 19.2.2 Maintenance Protocol
- 19.3 Maintenance of Fire Prevention and Safety Provisions
 - 19.3.1 Periodic Inspection and Maintenance Certificate

20 Conformity to other Acts and Rules

- 20.1 Minimum Clearance from Truck Infrastructure
 - 20.1.1 Minimum Clearance from Electric Lines
 - 20.1.2 Minimum Clearance from Petroleum Pipelines
 - 20.1.3 Minimum Clearance from Oil Well
 - 20.1.4 Minimum Clearance from Water Body
- 20.2 No Objection Certificates (NOC) / Approvals
 - 20.2.1 NOC from Coast Guard Authority
 - 20.2.2 NOC from Railways
 - 20.2.3 NOC from Commissioner of Police / Collector
 - 20.2.4 NOC from Jail Authority
 - 20.2.5 NOC from ASI
 - 20.2.6 NOC from UT Administration
 - 20.2.7 NOC from Defence Establishment
 - 20.2.8 Environmental Clearance
 - 20.2.9 NOC under CZMA
- 20.3 Conformity to Other Acts

21 Quality Control and Inspection

- 21.1 Applicability
- 21.2 Inspection and Safety Certificate

Table

Table No. 13.1	Maximum Permissible Height of Boundary Wall / Compound Wall for all Buildings
Table No. 13.2	Staircase Detail
Table No. 13.3	Corridor and Passageway
Table No. 13.4	Minimum Width of Ramp and Radius of Inner Curve
Table No. 13.5	Ramp Details Based on Area of Parking in Basement
Table No. 13.6	Ramp Details for Fire Tender
Table No. 13.7	Size of Ventilation Shafts
Table No. 13.8	Area and Floor Dimension of Bathroom and Water Closet
Table No. 13.9	Requirement of Sanitation
Table No. 13.10	Telecom room space norm for buildings with Built-up area >465 sq m
Table No. 13.11	Space requirements for smaller buildings with Built-up area <465 sq m
Table No. 13.12	Provision for Passengers Lift
Table No. 13.13	Size of Vehicle Lift shall be According to Weight of Car
Table No. 13.14	Occupant Load
Table No. 17.1	Reuse of Recycled Water
Table No. 17.2	Building Use Categories and Built-up Area for Provision of Solar Water Heating
Table No. 17.3	Norms for Roof Top Solar PV Installation and Generation
Table No. 17.4	Built up Area Norms for Environment Clearance
Table No. 20.1	Minimum clearance from Electric Lines

Figure

- Figure No. 13.1 Boundary Wall / Compound Wall for Building
- Figure No. 13.2 Details for Sloping Access Path
- Figure No. 13.3 Details for Stepped Approach
- Figure No. 13.4 Entrance Details
- Figure No. 13.5 Minimum Clear Height for Dwelling Unit/ Commercial Building
- Figure No. 13.6 Minimum Clear Height for Industries
- Figure No. 13.7 Minimum Clear Height for Folded Roof
- Figure No. 13.8 Minimum Clear Height for Sloping Roof
- Figure No. 13.9 Minimum Clear Height for Trussed Roof
- Figure No. 13.10 Minimum Clear Height for Hollow Plinth
- Figure No. 13.11 Minimum Clear Height for Basement
- Figure No. 13.12 Mezzanine Floor
- Figure No. 13.13 Fixing Detail of Railing/ Parapet
- Figure No. 13.14 Fixing Detail of Handrail to the Wall
- Figure No. 13.15 Details for Corridor and Passageway
- Figure No. 13.16 Ramp for Pedestrians
- Figure No. 13.17 Turning Facility for Fire Appliance (Left) and U - turn Facility for Fire Appliance (Right)
- Figure No. 13.18 Design of Parking for Cars
- Figure No. 13.19 Design of Parking for Two - Wheelers
- Figure No. 13.20 Signages
- Figure No. 13.21 Typical Toilet Details
- Figure No. 13.22 Details for External Façade
- Figure No. 17.1 Minimum Distance from Water Body and Water Course from Riverbank Boundary
- Figure No. 17.2 Minimum Distance from Water Body and Water Course from Riverbank Embankment
- Figure No. 17.3 Minimum Distance from Water Body and Water Course from Watercourse/ Water Boundary
- Figure No. 17.4 Percolation Pit or Bore Recharge.
- Figure No. 17.5 Percolation Well with Rainwater Harvesting System upto Ground First River (Left) and upto Ground Second River (Right)
- Figure No. 20.1 Minimum clearances from Electric Lines

13 Building and Infrastructure

13.1 Architectural Elements

13.1.1 Boundary Wall Compound Wall and Gate

- 1 The maximum height of the boundary wall / compound wall is given in Table No.13.1.
- 2 For building units at junction of roads, a grill fence shall be provided with the following provisions:
 - a) At least 50% perforation in the grill.
 - b) The base of the grill fence shall not exceed 0.8 m from the level of the crown of the adjacent road for a length of 9 m from the corner of the building unit at the junction.
- 3 Boundary gate shall not open outward and shall be provided with a means to prevent the gate from opening outward on the pavement or road.
- 4 The minimum width of a boundary gate for all uses except Dwelling 1 and 2 shall be 6 m.
- 5 For building unit at junction of roads, the following shall be applicable:
 - a) A gate shall not be permitted on the corner of the of the boundary wall.
 - b) If the adjacent road width is equal or more than 12 m, the opening in the boundary wall shall be located at a minimum distance of 15 m from the corner of the building unit at the junction. If the length of the building unit on the roadside is less than 15 m, the opening in the boundary wall shall be provided at the farthest end from the junction.

Table No. 13:1 Maximum Permissible Height of Boundary Wall / Compound Wall for all Buildings

No	Use	Maximum Height from crown of the Adjacent Road (m)	
		Roadside	Other than adjacent road / roadside or all other side of building-unit
(1)	(2)	(3)	(4)
1	Other than Industrial	1.5*	1.8
2	Industrial	3	3

Note: * Boundary wall of more than 1.5 m may be allowed with permission (Refer Figure No. 13.1).

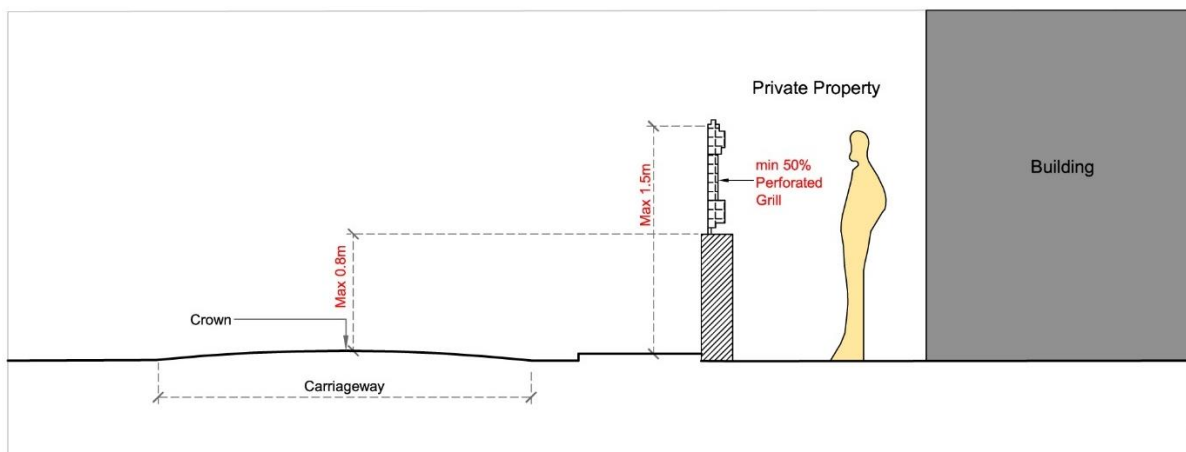

Figure No. 13.1: Boundary Wall / Compound Wall for Building

13.1.2 Level of Building Unit

The level of the building shall be established with respect to the average ground level or high flood level, as may be applicable. This level shall in no case be lower than street / road level of the adjacent road. For building units with access from two or more roads, the level of the wider road shall be considered.

In the case of a building unit where the level of the land is lower than the level of the road in front and which in the opinion of the Competent Authority, could be drained off in the storm water drainage and sewer, the Competent Authority may permit a suitable lower level.

Any difference between the building unit level and road level, shall be accommodated by filling etc. within the building unit boundary.

13.1.3 Paving in Building Unit

Maximum of 50% of the total open space including marginal open spaces and common plot of a building unit shall be paved. The remaining shall be permeable for rainwater percolation.

13.1.4 Access

Access for all Buildings

- 1 Access from the building unit entry to the building entry or the plinth shall have a minimum width of 1.8 m for DW1 and DW2 and 3.5 m for all other buildings. The surface shall be even.
- 2 In case of a sloping access path, the gradient shall not be greater than 1:15.
- 3 Selection of floor material shall be made suitably to attract or to guide visually impaired persons (limited to coloured floor material) whose colour and brightness is conspicuously different from that of the surrounding floor material or the material that emits different sound to guide visually impaired persons; hereinafter referred as "guiding floor material". Finishes shall have a non-slip surface with a texture traversable by a wheelchair. Kerbs wherever provided should blend well.

Ramped Access for all Buildings (Except Dwelling 1 and 2):

- 1 Minimum one ramp entrance shall be provided that is accessible by people with disability and accompanied by appropriate signages as per Rule No. 13.7.
- 2 Minimum width of the ramped access shall be 1.2 m, 1.5 m and 1.8 m for ramp having length upto 3.6 m, upto 9 m and more than 9 m respectively.
- 3 The pedestrian ramp leading main entrance required as per these Rules may be provided in the margin.
- 4 Ramp specifications shall be as follows:
 - a) The gradient shall not be greater than 1:15.
 - b) Minimum width of ramp shall be 1.2 m and the maximum continuous length shall be 9 m. Such ramp shall have 800 mm high handrail on both sides extending 300 mm beyond top and bottom of the ramp. Minimum gap from the adjacent wall to the handrail shall be 50 mm (*Refer Figure No. 13.2*).
 - c) Entrance landing shall be provided adjacent to ramp, with the minimum dimension 1.2 m x 1.5 m.
 - d) The surface shall be adequately prepared as a guide to visually impaired person by using colour and material guide brightness that is different from the surrounding floor material or by using 'guiding floor material' that emits different sounds.
 - e) Finishes shall have a non-slip surface traversable by a wheelchair.
 - f) Kerbs, wherever provided, should blend to a common level.

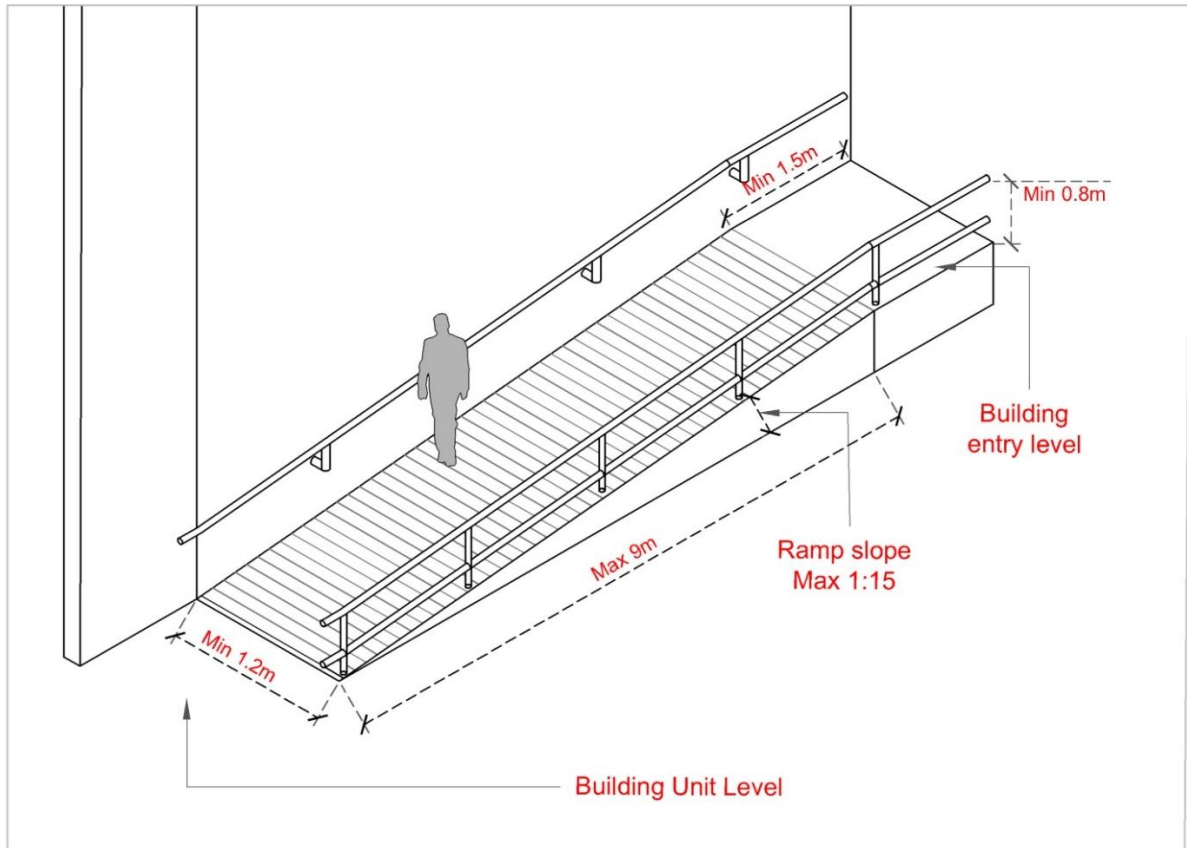

Figure No. 13.2: Details for Sloping Access Path

Additional stepped approach for all buildings:

- a) Minimum width shall be 1.35 m.
- b) Size of tread shall not be less than 300 mm and maximum riser shall be 150 mm.
- c) The steps shall not have abrupt (square) nosing.
- d) Maximum number of risers on a continuous flight without landing shall be limited to 12.
- e) The stepped approach shall be provided with 1150 mm, high handrail on both sides. Handrails shall extend 300 mm on the top and bottom flight of the steps.
- f) All steps edges shall have a contrasting colour band of 50 mm width stretched entirely across the step width.
- g) The edges should also be non-slippery.

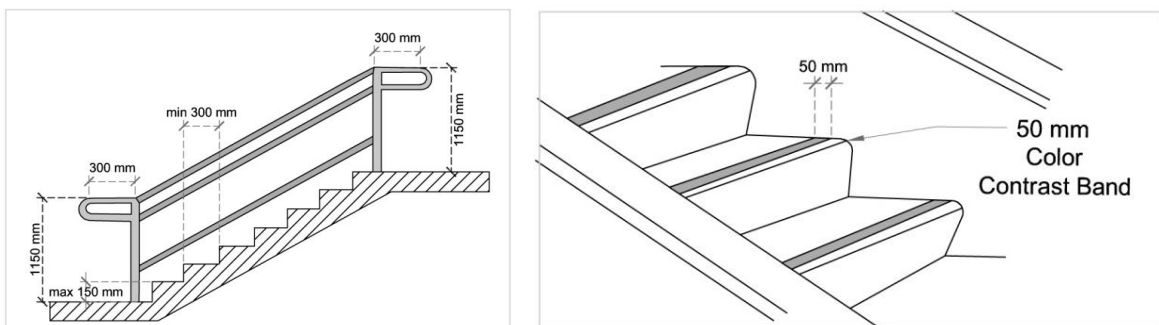

Figure No. 13.3: Details for Stepped Approach

13.1.5 Plinth

- 1 The plinth of the habitable area of any building shall be at a minimum height of 0.45 m from the established level of the building unit.
- 2 The building may be permitted on hollow plinth at the ground level, with the following provisions:
 - a) Maximum height shall be 3.5 m from finished ground level to finished next floor level and minimum height shall be 3 m from finished ground level to finished next floor level. The minimum clear height from finished ground level to finished beam bottom shall be 2.1 m.
 - b) It is free of enclosures except for staircase and other permitted uses under these Rules.

13.1.6 Entrance

For all buildings except Dwelling 1 and 2, entrance with the following specifications shall be provided:

- 1 Minimum clear opening of the entrance door shall be 900 mm wide and shall not be provided with a step that obstructs the passage of a wheelchair user.
- 2 Level difference at threshold shall not exceed 12 mm.
- 3 Glazed Manual doors should incorporate kick plates 300 mm high to withstand impact of wheelchair footrest.
- 4 Door handle and locks should be positioned between 900 – 1000 mm above floor level and must enable the user to operate it with a single hand. For special use cases, the applicant may provide different door handles with prior permission of the Competent Authority. (Refer Figure No. 13.4).

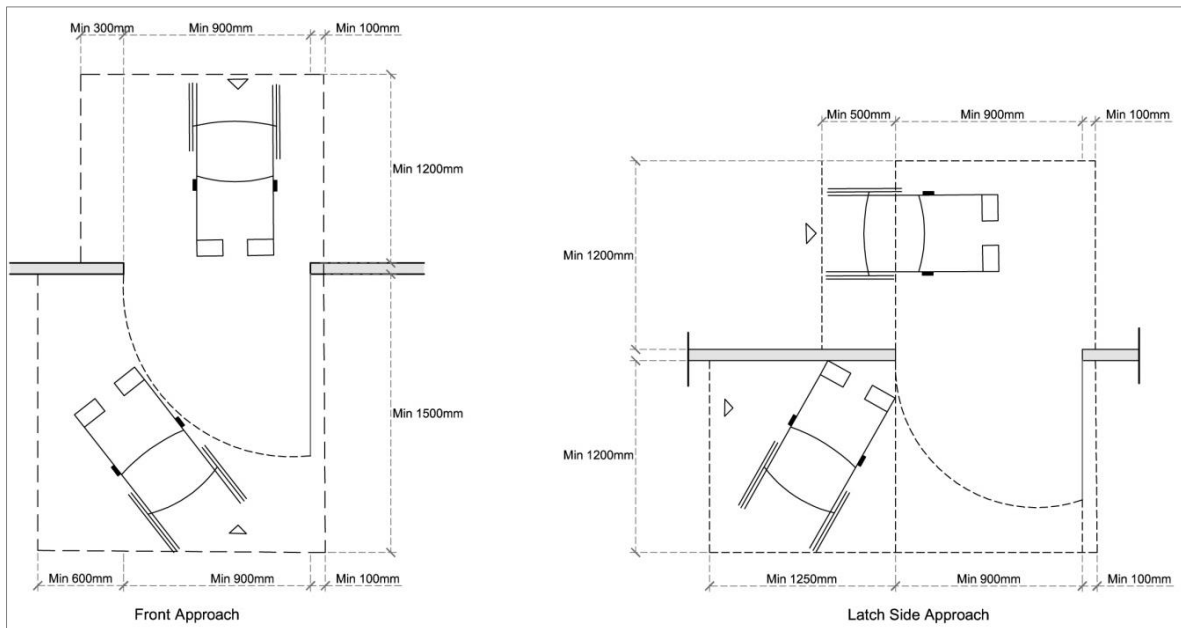

Figure No. 13.4: Entrance Details

13.1.7 Minimum Clear Heights in Buildings

- 1 For Dwelling Units or Mercantile Buildings (Refer Figure No. 13.5):
 - a) All habitable spaces shall have minimum height of 2.9 m between finished floor levels.
 - b) All circulation and service spaces such as verandah, bathroom, washroom, toilet, passage, puja room, storeroom and stair cabin shall have a minimum clear height of 2.1 m.

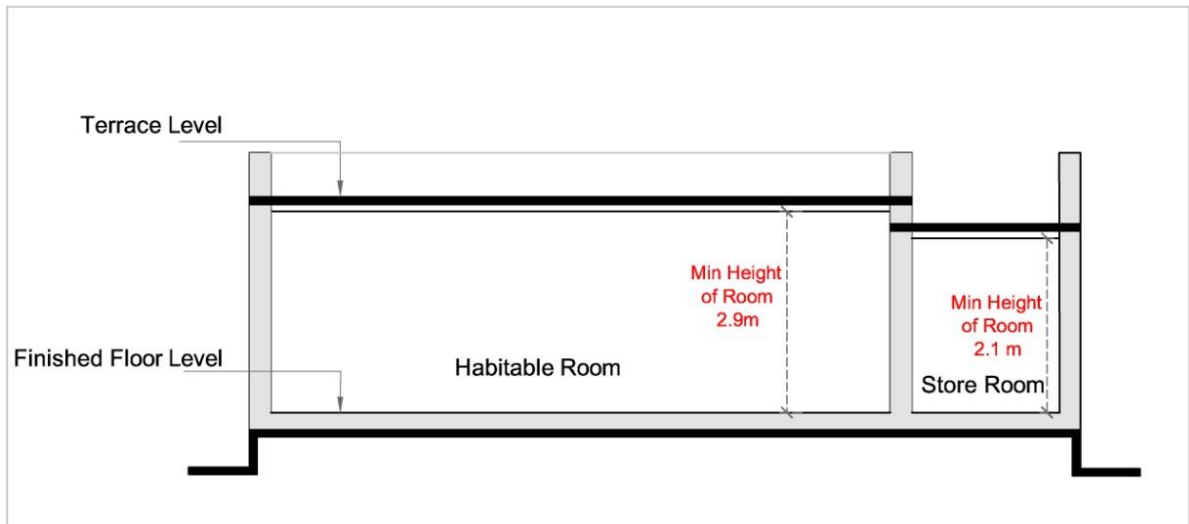

Figure No. 13.5: Minimum Clear Height for Dwelling Unit/ Commercial Building

- 2 For industrial uses, all spaces shall have a minimum clear height of 3.5 m (Refer Figure No. 13.6).

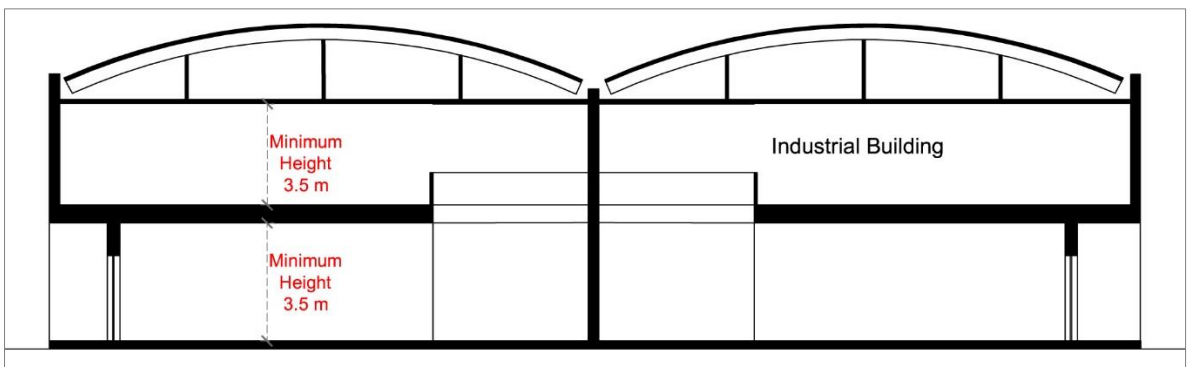

Figure No. 13.6: Minimum Clear Height for Industries

- 3 In case of folded roof, minimum clear height shall be 3 m (measured from the lowest point of the fold) (Refer Figure No. 13.7).

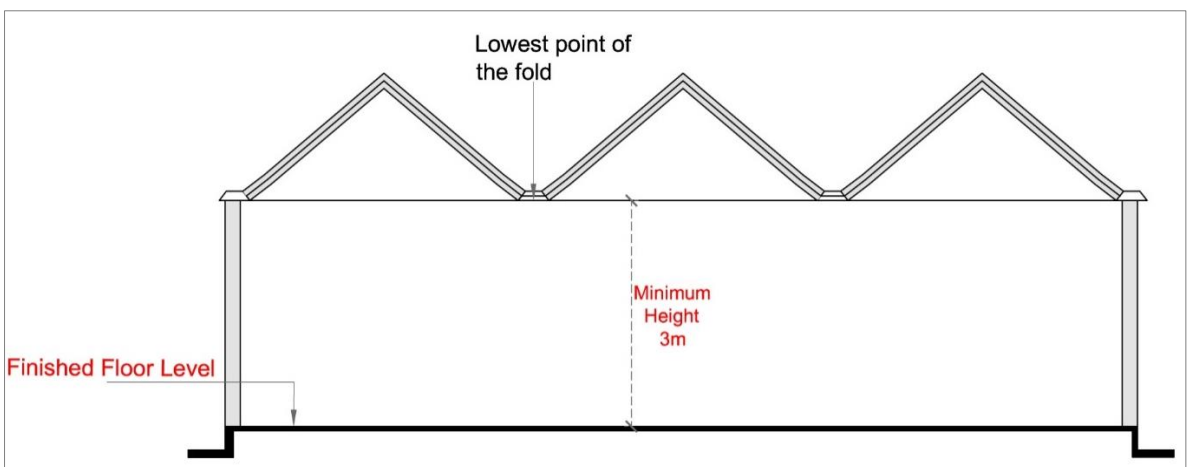

Figure No. 13.7: Minimum Clear Height for Folded Roof

- 4 In case of sloping roof, minimum clear height shall be 2.2 m (measured from the lowest point of the roof). The average height of the room shall not be less than the minimum clear height of 2.9

and 3 as may be applicable according to the building use and stipulated above (Refer Figure No. 13.8).

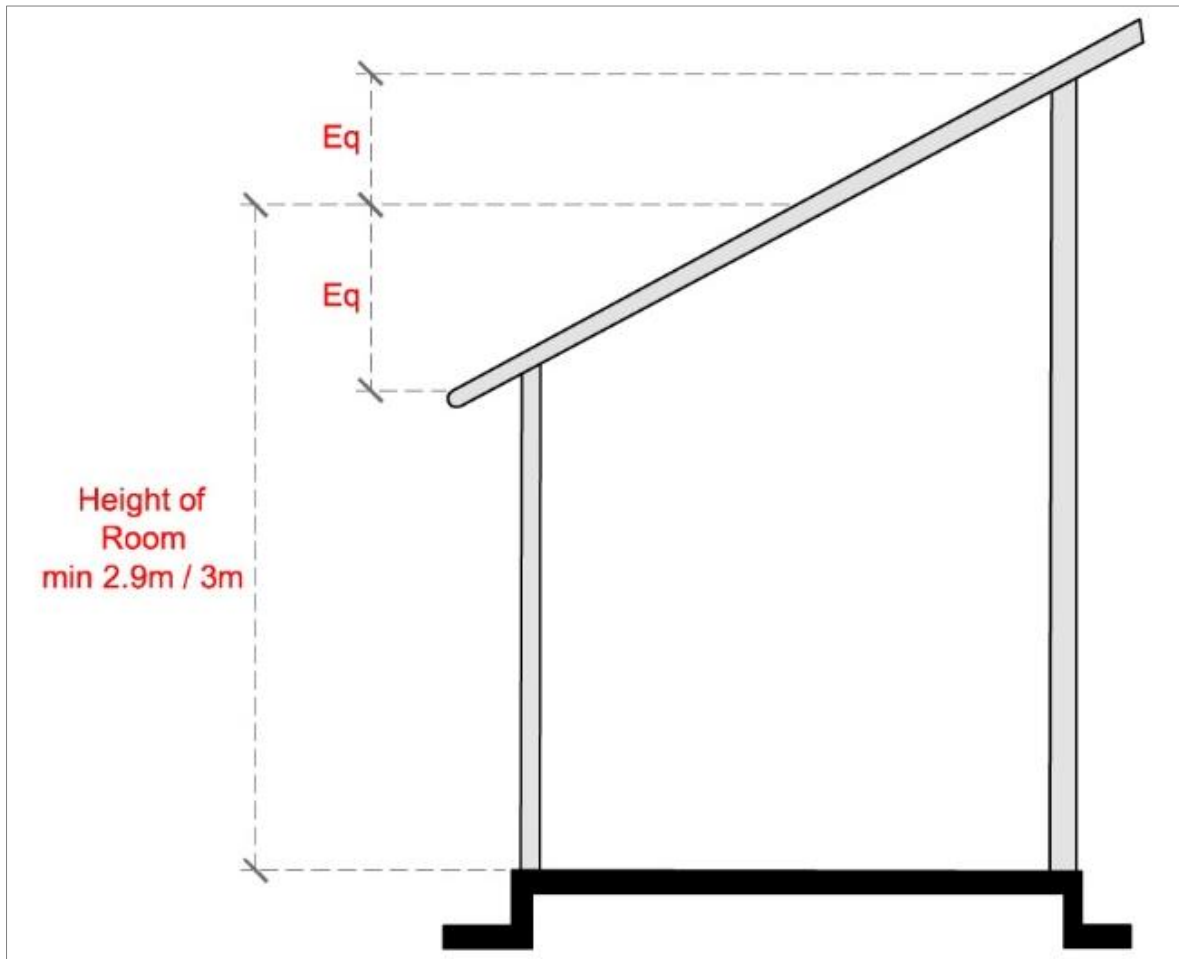

Figure No. 13.8: Minimum Clear Height for Sloping Roof

- 5 In case of trussed roof, minimum clear height shall be measured from the floor level to the bottom of the tie beam and shall be 2.8 m (Refer Figure No. 13.9).

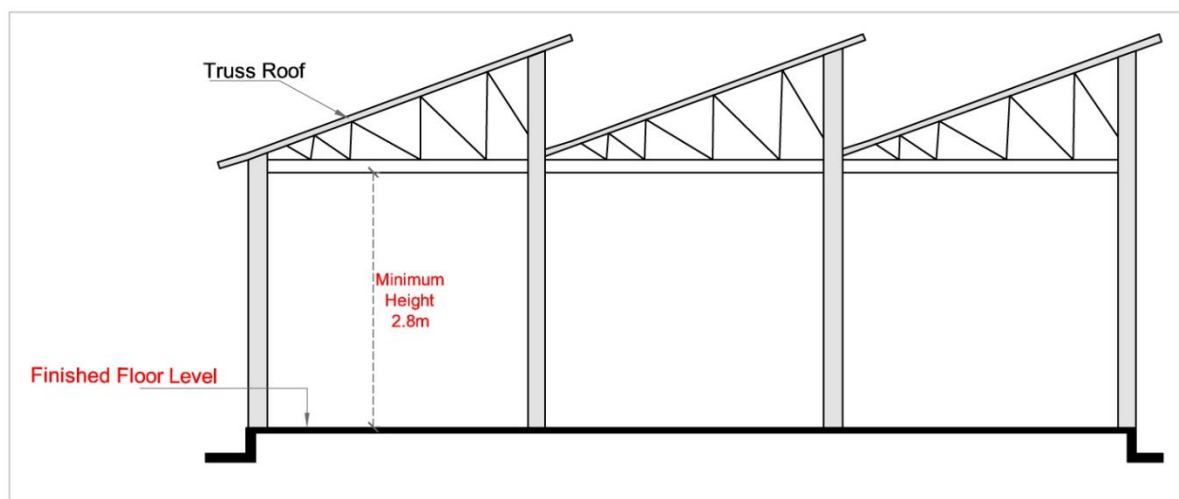

Figure No. 13.9: Minimum Clear Height for Trussed Roof

- 6 In case of hollow plinth, from finished ground level to finished next floor level provided for the purpose of parking shall have maximum clear height of 3.5 m (Refer Figure No. 13.10).

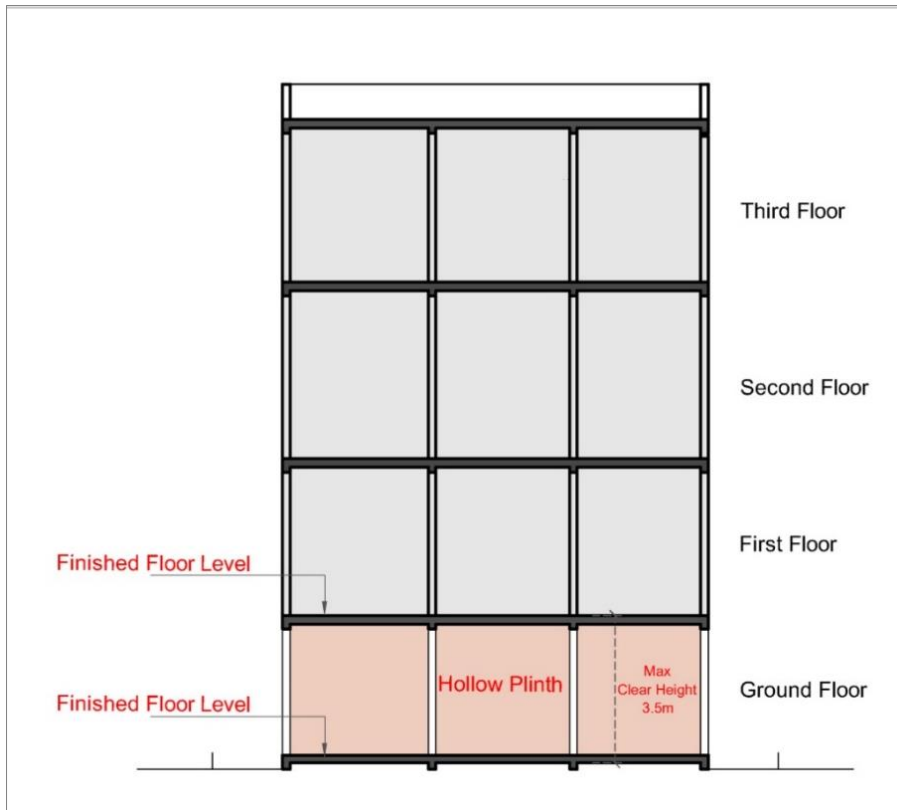

Figure No. 13.10: Minimum Clear Height for Hollow Plinth

- 7 In case of basement, exclusively used for parking shall have minimum clear height of 2.8 m, and maximum clear height of 4.5 m. In case of mechanical parking more height may be permitted (Refer Figure No. 13.11).

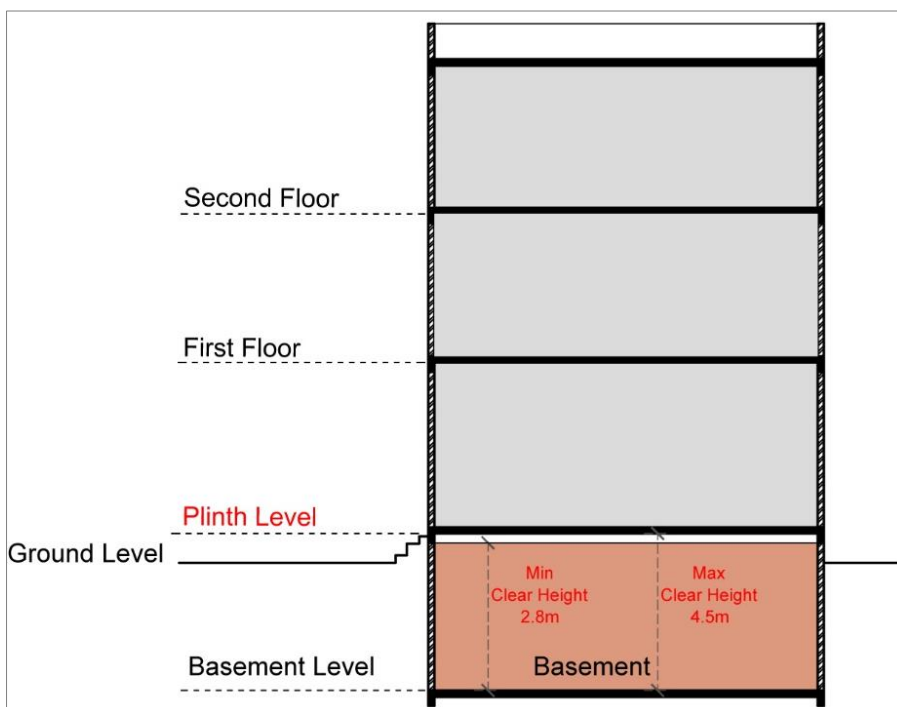

Figure No. 13.11: Minimum Clear Height for Basement

13.1.8 Mezzanine

Mezzanine floor shall have a minimum clear height of 2.1 m from the finished floor level in a room. The area must not exceed 30% of the area of the enclosed space. Its area shall be counted in FSI (Refer Figure No. 13.12).

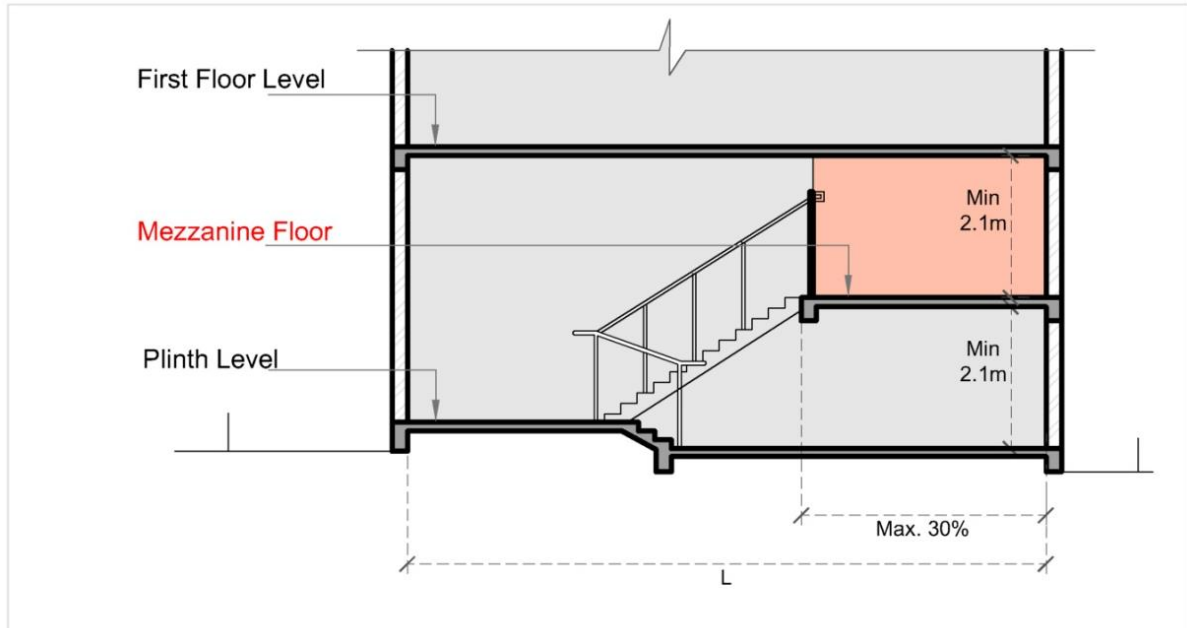

Figure No. 13.12: Mezzanine Floor

13.1.9 Loft

Loft of a maximum height of 1.2 m may be allowed in a room at a minimum clear height of 2.1 m from the finish floor level. The loft shall not cover more than 30% the floor area of the enclosed space / room. In case the loft is in bathroom, WC, or toilet 100% of the floor areas bath, WC or toilet respectively shall be permitted for the loft.

13.1.10 Railings / Parapet

- 1 Parapet walls / handrails provided on the edges of the roof, terrace, balcony, staircase, large openings, fully glazed windows etc. shall not be less than 1.15 m from the finished floor level and not more than 1.5 m height above floor level.
- 2 Construction of parapet / handrails shall be of such material and design, that it ensures optimum safety to the user / occupants of the building.
- 3 The maximum dimension of the railing / parapet members shall not exceed 0.15 m (Refer Figure No. 13.13).

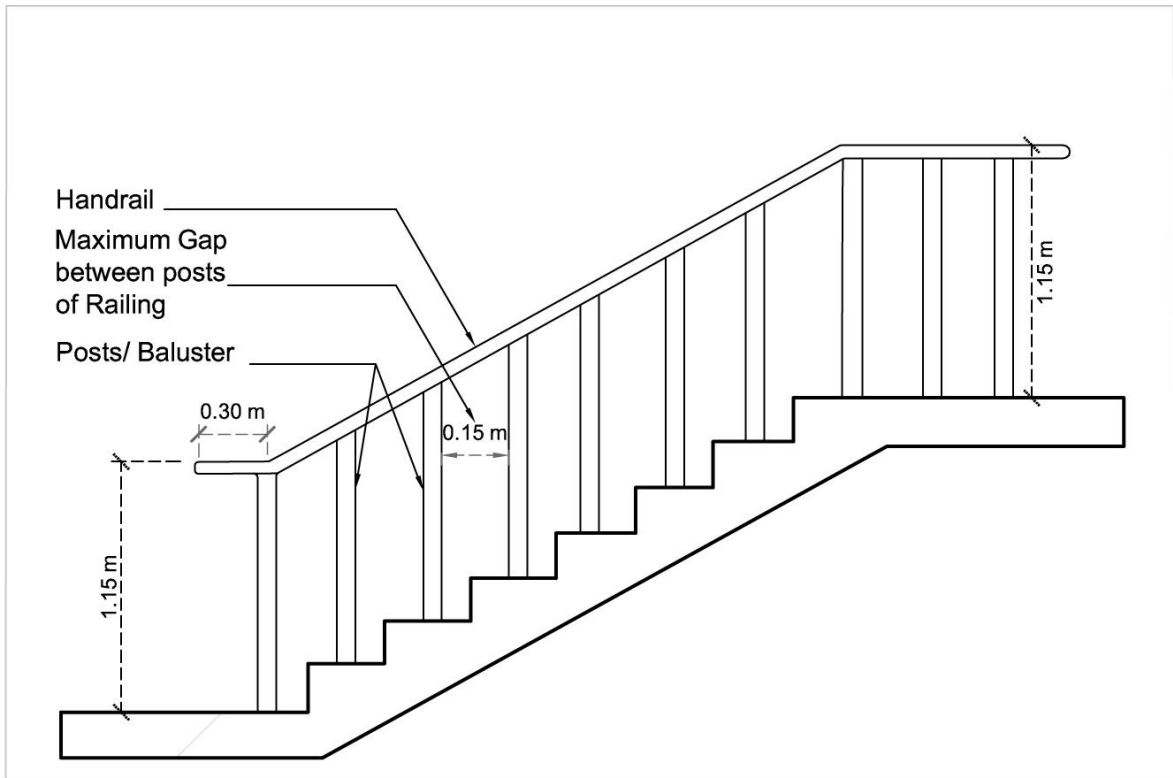

Figure No. 13.13: Fixing Detail of Railing/ Parapet

- 4 In buildings meant for predominant use by children, it will be necessary to suitably alter the height of the fixtures.
- 5 Hand – rail shall be provided with a pipe of minimum diameter of 40 mm and as illustrated across (Refer Figure No. 13.14).
6. The parapet/ handrail height shall not be included while calculating the height of the building.

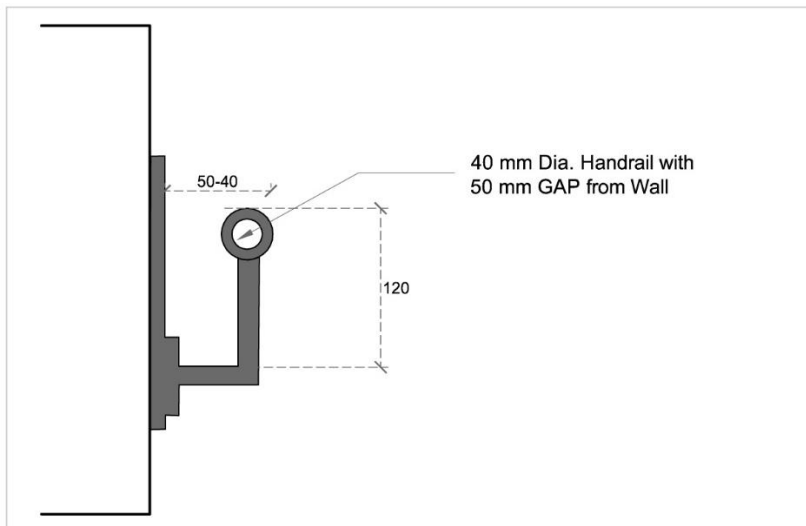

Figure No. 13.14: Fixing Detail of Handrail to the Wall

13.1.11 Terrace

Terrace of a building shall be accessible by a common staircase and shall be free from partitions.

13.1.12 Staircases, Corridors and Passageway

1 Staircase

Staircase in a building and its specifications shall be determined as mentioned in the Table No. 13.2 below. The minimum width of the flight shall be exclusive of parapet and floor mounted railing.

Table No. 13.2: Staircase Details

No	Use	Height of Building (m)	Staircase			Maximum Travel Distance (m)	
			Minimum Flight Width (m)	Minimum Tread (mm)	Maximum Riser (mm)		
(1)	(2)	(3)	(4)	(5)	(6)	(7)	
1a	Dwelling 1 and 2	Three floors, upto ≤ 12	1	250	250	30 (R)	25 (NR)
1b	Dwelling 3	≤ 12	1.2	250	180	30 (R)	25 (NR)
1c		>12 & ≤ 25	1.5	250	180		
1d		>25	2	300	160		
2a	Non-Residential Uses except Industrial and Assembly Uses	≤ 25	1.5	300	160	25	
2b		>25	2	300	160		
3	Assembly	For all heights	2	300	160	25	
4	Industrial	For all heights	1.5	300	160	25 (non-HZ) 20 (HZ)	
<p>“R” means Residential. “NR” means Non-residential Use, Mixed-Use “HZ” means Hazardous</p>							

- a Staircase for basement:
 - i The staircase to the basement shall have the same width as the regular staircase leading to upper floors.
 - ii Any staircase leading to the basement shall be as per Fire Rules in Part 3 (II) amended from time to time.
 - iii A staircase shall be provided from the lowest level of the basement as a means of access or exit at a travel distance mentioned in the Table No. 13.2.
- b Staircase for all buildings other than detached and semi-detached dwelling units: Separate staircases shall be provided if a building has residential and non-residential uses.
- c For all buildings, staircase shall be compliant with Fire Rules in Part 3 (II) amended from time to time.

2 Corridor and Passageway (Refer Figure No. 13.15)

For all buildings except Dwelling 1, the minimum clear width of corridors and passageways shall be as under:

Table No. 13.3: Corridor and Passageway

No	Length of Corridor (m)	Width of Corridor (m)	
		Residential	Non-Residential
(1)	(2)	(3)	(4)
1	Up to 6	1.2	1.2
2	Up to 9	1.2	1.5
3	Up to 15	1.2	2.0
4	Above 15 and up to 24	1.5	2.5
5	24 and above	2.0	3.0

- a) Corridor shall be clear of any obstructions. No projection in any form shall be allowed up to a height of 2.1 m from floor level.
- b) The minimum height of corridor shall be 2.1 m from finished floor level.
- c) In case of any level difference in a corridor, a slope shall be provided with gradient not more than 1:15. In such case, guiding floor material shall be provided.
- d) In case of all types of building, if the building height is more than 15 m and there is no natural ventilation on either side of corridor, then smoke / air exhaust system or alternatively pressurization system with supply air system for these exit access corridors shall be required.

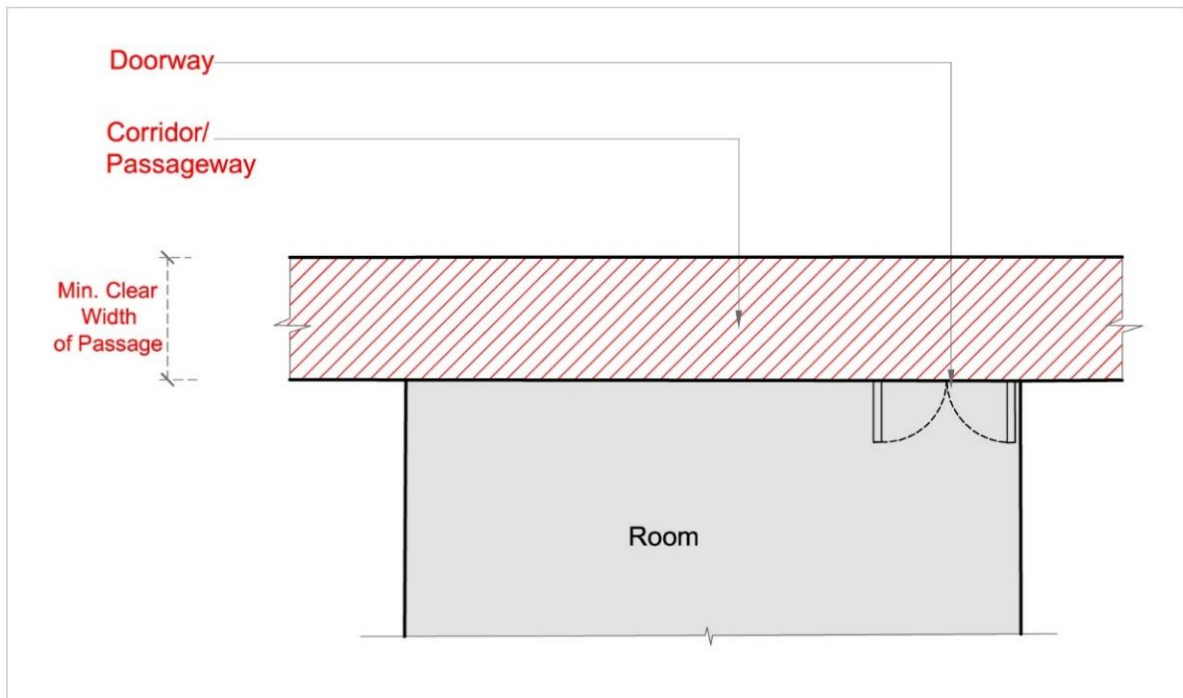

Figure No. 13.15: Details for Corridor and Passageway

13.1.13 Ramp

1 Ramp for Vehicular Access:

Minimum width and radius for a ramp for two wheelers, cars, and trucks, respectively are specified in the Table No. 13.4 below:

Table No. 13.4: Minimum Width of Ramp and Radius of Inner Curve

No (1)	Vehicle (1)	Minimum width of Ramp (m) (2)	Minimum Radius of Inner Curve (m) (3)
1	Two-wheeler	2	2
2	Car	3	3
3	Truck	6	4

- a) The maximum slope of ramp shall be 1:10.
- b) A level platform of width equal to ramp width and length of minimum 4.5 m shall be provided at end of the ramp at ground level and basement level.
- c) A minimum clear height of 2.6 m shall be maintained at all points on the ramp.
- d) For parking in basements, the number and width of ramp shall be provided as specified below and as per Table No. 13.5 (as applicable)

Table No. 13.5: Ramp Details Based on Area of Parking in Basement

No (1)	Area of Parking in Basement (1)	Number of Ramps (2)	Width of Ramp (3)
1	≤750 sq m	1	3 m
2	>750 sq m	1	6 m
		2	3 m each

2 Ramp for Pedestrians (*Refer Figure No. 13.16*):

- a) For buildings exceeding 4 m in height with uses namely, Public Offices, Assembly, Educational 2 & 3, Mercantile 1, 2 & 3; a pedestrian ramp shall be provided unless provision for a lift is made as per Rule 13.12. The ramp shall be provided with the following specifications:
 - b) The minimum width of the ramp shall be 1.2 m, 1.5 m and 1.8 m for the ramp length upto 3.6 m, up to 9 m and more than 9 m respectively.
 - c) A landing shall be provided of 1.8 m length for every 9 m length of the ramp.
 - d) The slope of a ramp shall not exceed 1:15.
 - e) Surface of the ramp shall be slip-resistant, and the edge of the ramp shall be protected with a minimum height of 100 mm.
 - f) Handrails on the ramps shall be on both sides at two levels, at 700 mm and 900 mm, both ends shall be rounded, grouted, and extended 300 mm beyond top and bottom of ramp.
 - g) Entrance landing shall be provided at the starting and ending level of the ramp with the minimum length equal to 1.8 m.
 - h) Ramps shall lead directly to outside open spaces at ground level or courtyards or other safe places.

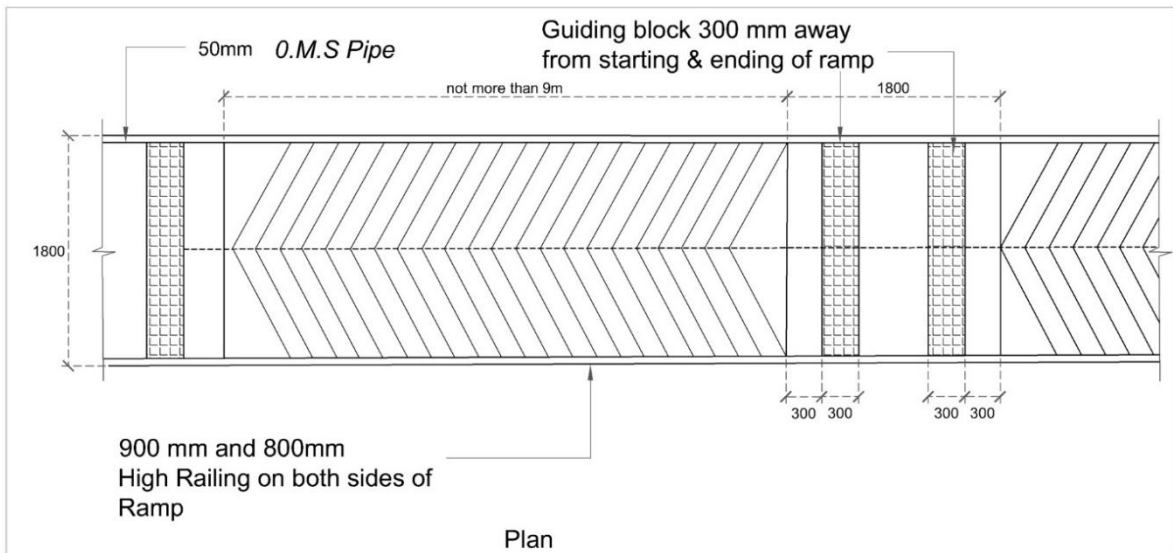
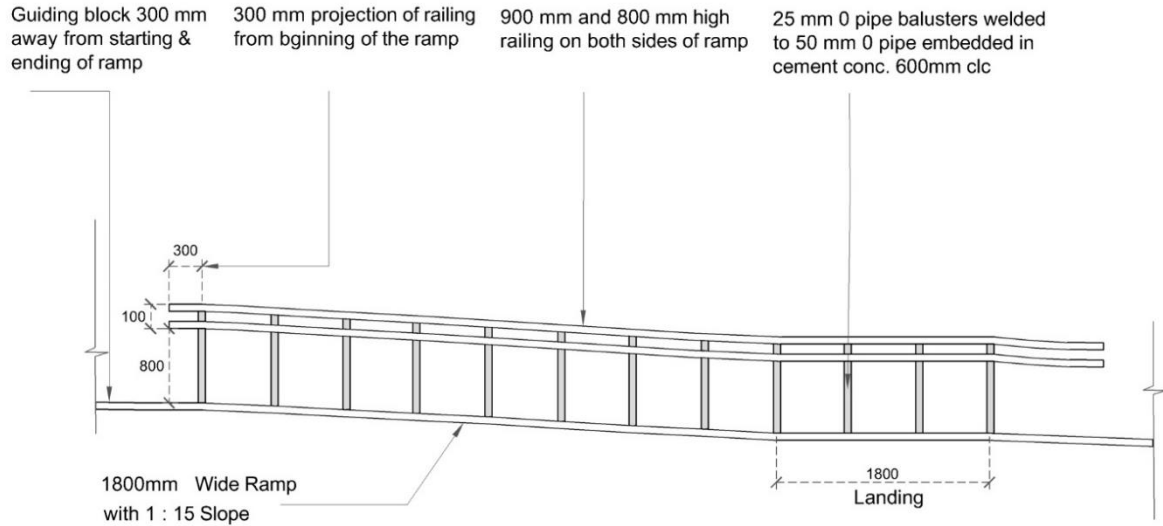

Figure No. 13.16: Ramp for Pedestrians

3 Ramp for Fire Tender:

- a) For parking except basements, hollow plinth at ground level and ramp leading to parking above ground level at any floor shall be permissible inside/rear margin are subject to any site/building unit which fulfils following minimum requirement in case of building height exceeds 25 m.

Table No.13.6: Ramp Details for Fire Tender

No.	Requirement	Particular
1	Minimum Gross Operational weight	30 Ton
2	Minimum Overhead Clearance	4.5 m
3	Minimum Width of Fire Appliance Accessway	3.5 m
4	Minimum Width of Perimeter Vehicular Access for Large Isolated Building	6 m
5	Minimum Lateral Clearance	2 m
6	Hardstanding	6 m wide x 15 m long
7	Minimum Turning Circle Kerb / Kerb	24 m
8	Minimum Turning Circle Wall/ Wall	28 m
9	Maximum Dead end	45 m

No.	Requirement	Particular
10	Maximum Gradient	1:15

4 Turning Facilities

Fire appliance access leading to a dead end shall neither exceed 45 m nor be less than 15 m in length. If the length exceeds 45 m, then turning facilities at the dead end (a turning circle or a hammerhead) must be provided (Refer Figure No. 13.17) (Left Image).

The outer radius for turning in an access way and fire appliance access road shall comply with the requirements (Refer Figure No. 13.17) (Right Image)

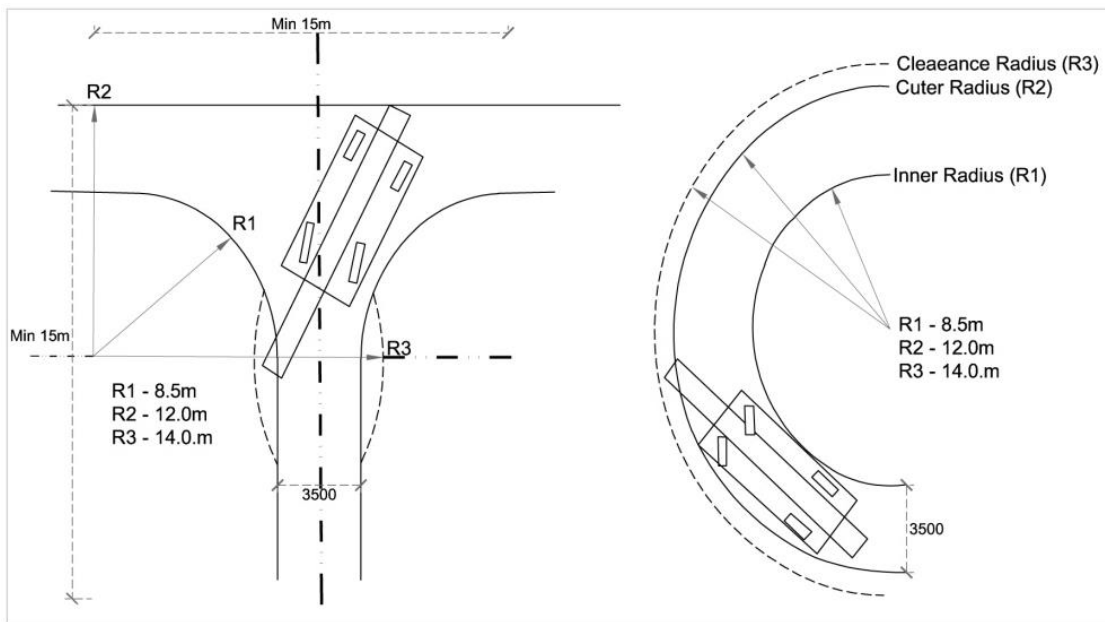

Figure No. 13.17: Turning Facility for Fire Appliance (Left) and U - turn Facility for Fire Appliance (Right)

13.1.14 Façade Maintenance Requirement

The Competent Authority may identify certain streets and areas that have a builtform that is special / historic. For these streets and areas, it may introduce additional architectural controls and guidelines from time to time which will need to be followed in addition to these Rules. The Competent Authority may announce incentives for this.

13.2 Parking

13.2.1 Parking to be Provided

- 1 In any building, provision for parking shall be made as per requirements specified in Rule 16.5 Schedule No.16.
- 2 Parking for people with disability shall be provided for all buildings and facilities other than Dwelling 1 and 2 as per Rule No.13.2.2 (5).

13.2.2 Parking Layout Specifications for Cars (Refer Figure No. 13.18)

Parking layout for cars in all buildings shall conform to the following specifications:

- 1 Minimum dimension of a space provided for parking a car shall be 2.5 m x 5.5 m.
- 2 Each car parking space should be connected to the street providing access to the building unit by means of an access / exit lane.
- 3 Minimum width of the access / exit lane for single sided parking shall be 3 m and for double sided parking layout, the minimum width of the access lane shall be 5.5 m.

- 4 A minimum clear height of 2.6 m shall be maintained at all points in the parking space and access / exit lanes.
- 5 Minimum provision of two accessible car parking space shall be provided for people with disability for every 25 car parking spaces or less. This accessible car parking space shall:
 - a) Have a minimum bay width of 2.5 m.
 - b) Have a 1.2 m side transfer bay. This can be shared by two successive parking bays.
 - c) Be located within 30 m from the main entrance of the building.
 - d) Have appropriate signages indicating that the space is reserved for wheelchair that are conspicuously displayed as specified in Rule No. 13.7.
 - e) Have guiding floor materials or have a device to guide visually impaired persons with audible signals or any other devices which serves the above purpose.

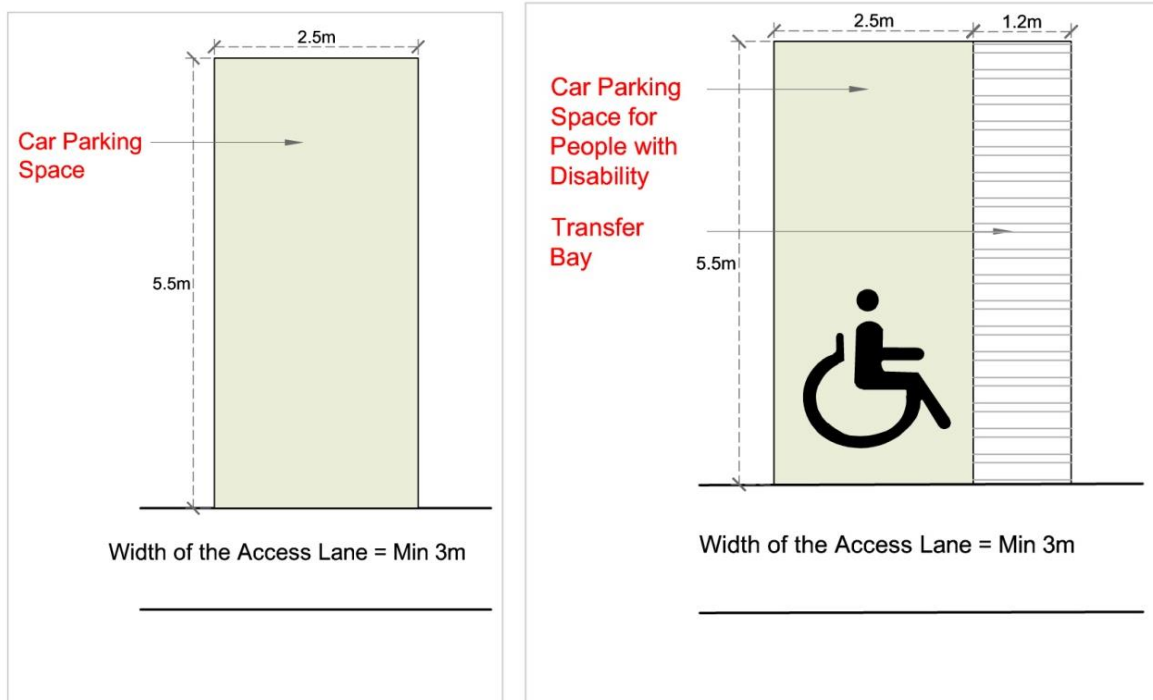

Figure No. 13.18: Design of Parking for Cars

13.2.3 Parking Layout Specifications for Two Wheelers (Refer Figure No. 13.19)

Parking layout for two wheelers in all buildings shall conform to the following specifications:

- 1 Minimum dimension of a space provided for parking a two-wheeler shall be 0.90 m x 2 m.
- 2 Each two-wheeler parking space should be connected to the street providing access to the building unit by means of an access / exit lane. Minimum width of the access / exit lane shall be 2 m.
- 3 A minimum clear height of 2.6m shall be maintained at all points in the parking space and access / exit lanes.

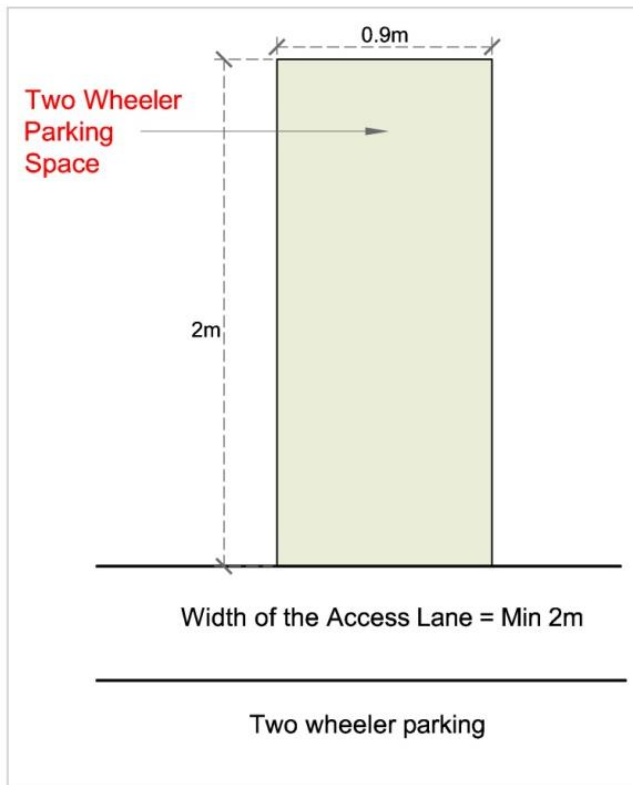

Figure No. 13.19: Design of Parking for Two - Wheelers

13.2.4 Parking Layout Specifications for Trucks

Parking layout for trucks in all relevant buildings shall conform to the following specifications:

- 1 Minimum dimension of a space provided for parking a truck shall be 4 m x 8 m.
- 2 Each truck parking space should be connected to the street providing access to the building-unit by means of an access / exit lane. Minimum width of the access / exit lane shall be 6 m.

13.2.5 Specified Parking for Loading and Unloading

- 1 Loading and unloading space shall be provided as per Rule No. 6.15 (1) in Industrial, Storage and Mercantile 1, 2, 3 except the following:
Shops / shopping centre / shopping malls having aggregate carpet area up to 1000 sq m, restaurant, hospitals of any category, nursing home, business establishment, light home workshop, activity related to IT, call centre and training centre and laboratory.
- 2 In case of mixed development, the loading and unloading space shall be provided for the area referred in (1) above on prorata basis. Such loading unloading space requirements shall be provided in a manner that 3.5 m x 7.5 m shall be provided at the rate of one space for every 1000 sq m of carpet area or part thereof.
- 3 The ramps leading to loading and unloading space provided as per (1), (2) shall have minimum 6 m width. Such ramp provided for loading unloading may also be used for the purpose of approach to parking.
- 4 The loading and unloading space shall be permitted on ground level or in first basement. It shall be considered as a part of parking area.

13.3 Lighting and Ventilation

13.3.1 Lighting and Ventilation of Rooms

- 1 Every habitable and usable room shall be equipped for adequate lighting and ventilation by provision of windows and /or ventilators that open directly into an open space or semi open space such as courtyard or verandah. The size of such an open space shall be minimum one tenth of the floor area of the room.

- 2 The aggregate of all openings including doors, windows and ventilators in a room shall be minimum one seventh of the floor area of the room.
- 3 Where lighting and ventilation requirements are not met through day lighting and natural ventilation, they shall be ensured through artificial lighting and ventilation in accordance with the provisions of Part VIII Building Services, Section I Lighting and Ventilation, National Building Code and to the satisfaction of the Competent Authority.

13.3.2 Ventilation of Basement

Every basement shall be ventilated adequately for its respective use. Vent duct openings shall be permitted at building unit level in accordance with Fire Rules in Part 3 (II) and amended from time to time. Any deficiency shall be compensated by use of mechanical system such as blowers, exhaust fans or air conditioning system according to the standards in Part VIII Building Services, Section-I Lighting and Ventilation, National Building Code, and to the satisfaction of the Competent Authority.

13.3.3 Ventilation of Atrium

Any atrium covered from top shall be provided with adequate provision of light and ventilation.

13.3.4 Ventilation of Bathrooms and Water Closets

- 1 Every bathroom and water closet shall be ventilated adequately.
- 2 At least one of the walls of a water closet or bathroom or sanitary block shall have an opening of minimum 0.30 sq m with one dimension of 0.3 m, for each unit of WC or bathroom. In case the WC or bathroom abut a ventilation shaft, its size shall be as per the Table No 13.7 in Rule No 7.14.2:

Table No. 13.7: Size of Ventilation Shafts

No.	Height of Building (m)	Cross Section of Ventilation Shaft (sqm)	Side of Shaft (m)
1	Upto 12m	2.8	1.2
2	Upto 18m	4	1.5
3	Upto 30m	5.4	1.8
4	Above 30m	8	2.4

- 3 Where lighting and ventilation requirements are not met through day lighting and natural ventilation, they shall be ensured through artificial lighting and ventilation in accordance with the provisions of Part VIII Building Services, Section I Lighting and Ventilation, National Building Code and to the satisfaction of the Competent Authority

13.3.5 Ventilation of Staircase for Dwelling 1 and 2

- 1 Ventilation by windows:
Every staircase shall be ventilated adequately from an open-air space with a minimum area of 1 sqm. The aggregate area of all windows provided shall be at least 1.2 sq m at each stair landing or floor in the enclosing wall of the staircase which abuts on such 1 sq m open air space.
- 2 Mechanical ventilation:
Where lighting and ventilation requirements are not met through day lighting and natural ventilation, they shall be ensured through artificial lighting and ventilation in accordance with the provisions of Part VIII Building Services, Section I Lighting and Ventilation, National Building Code and to the satisfaction of the Competent Authority.

13.3.6 Ventilation of Industrial Building

- 1 Every usable room shall be equipped for adequate ventilation by provision of windows, ventilators, skylights, or artificial means.
- 2 For natural light and ventilation, every room in such building shall be lit and ventilated by adequate number of windows, ventilators, and sky lights exclusive of doors having clear

opening not less than 1/7th of the floor area abutting on open air space of width not less than 1/3rd of the height of the part of the building abutting such open space.

- 3 Where lighting and ventilation requirements are not met through day lighting and natural ventilation, they shall be ensured through artificial lighting and ventilation in accordance with the provisions of Part VIII Building Services, Section I Lighting and Ventilation, National Building Code and to the satisfaction of the Competent Authority.

13.3.7 Ventilation of Special Buildings

- 1 Every auditorium, halls and other special buildings shall be naturally lit and ventilated by doors, ventilators and windows abutting on an interior or exterior open air space which shall not be less than 1/5th of the total floor area.
- 2 Special buildings may be designed with through artificial lighting and ventilation in accordance with the provisions of Part VIII Building Services, Section I Lighting and Ventilation, National Building Code and to the satisfaction of the Competent Authority.

13.3.8 Change of Ventilation System

No permission shall be granted to convert an existing air-conditioned theatre to a non-air conditioned theatre.

13.4 Heating and Air Conditioning

Adequate heating and air conditioning as published in the National Building Code of India, Part VIII – Building Services, Section 3 Air Conditioning, shall be provided in all parts of a building and to the satisfaction of the Competent Authority.

13.4.1 Air Conditioning of Special Buildings

Auditorium or cinema halls shall be air-conditioned as per following specifications:

- 1 Temperature Range – 22 to 26.5 degrees Celsius (72° F to 80° F).
- 2 Change of Air per hour – approximately 10 times.
- 3 Relative Humidity – 50 to 60%.
- 4 Fresh Air Requirement – 7.5 CFM per person.

13.5 Water Supply Requirements

13.5.1 Water Storage Tank

Water storage tank shall be maintained to be perfectly mosquito proof condition, by providing a properly fitting hinged cover and every tank more than 1.50 m in height shall be provided with a permanently fixed non-ferrous metal ladder to enable inspection by anti-malaria staff.

13.5.2 Drinking Water Supply

In all buildings other than residential buildings, suitable provision of drinking water shall be made for people with a disability near the accessible toilet provided under Rule No. 13.9.2.

13.6 Building Signage

Signage directly pertaining to the use of the building may be erected on the plot.

For all buildings other than Dwelling 1 and 2, signage pertaining to the internal building uses shall be provided. Such signage shall comply with the following:

- 1 The size of lettering shall not be less than 20 mm to enable easy legibility.
- 2 Public address system may also be provided in busy public areas.
- 3 The symbols or information should be in contrasting colour and properly illuminated to help people with limited vision to differentiate amongst primary colours.
- 4 International symbol mark for wheelchair (*Refer Figure No. 13.20*) shall be installed at the lift, toilet, staircase, parking areas etc., that have been provided for people with a disability.

- 5 For educational, institutional and government buildings, information board in braille shall be installed on a wall near the entrance at a suitable height and such that is approachable.
- 6 To ensure safe walking, there should not be any protruding sign which creates obstruction in walking.



Figure No. 13.20: Signages

13.7 Letter Box

In all case of a building having more than two floors including ground floor, a letter box for each separate unit shall be provided at ground floor level to facilitate easy mail delivery.

13.8 Sanitation

Minimum sanitary accommodation shall be provided for all proposed buildings and additions and extensions to existing buildings.

13.8.1 For Residential Buildings

The minimum sanitary requirement for a residential dwelling unit shall be one water closet. The dimensions and area of WC and Bathroom are given in Table No. 13.8 below:

Table No. 13.8: Area and Floor Dimension of Bathroom and Water Closet

No	Type	Area (sq m)	Minimum Length of one side (m)
1	Bathroom	1.5	1.1
2	Water Closet (WC)	1.1	0.9
3	Combined bathroom & Water closet	2.2	1.1

13.8.2 For all Buildings other than Residential (Refer Figure No. 13.21)

- 1 Minimum one special water closet shall be provided for the use of persons with disability with provision of washbasin and drinking water at the ground level.
 - a Minimum size of toilet shall be 1.5 m X 1.75 m.
 - b Minimum width of door shall be 900 mm with outward door swing.
 - c Suitable arrangement of vertical or horizontal handrails with 50 mm clearance from the wall shall be provided.
 - d WC seat shall be 500 mm from the floor.

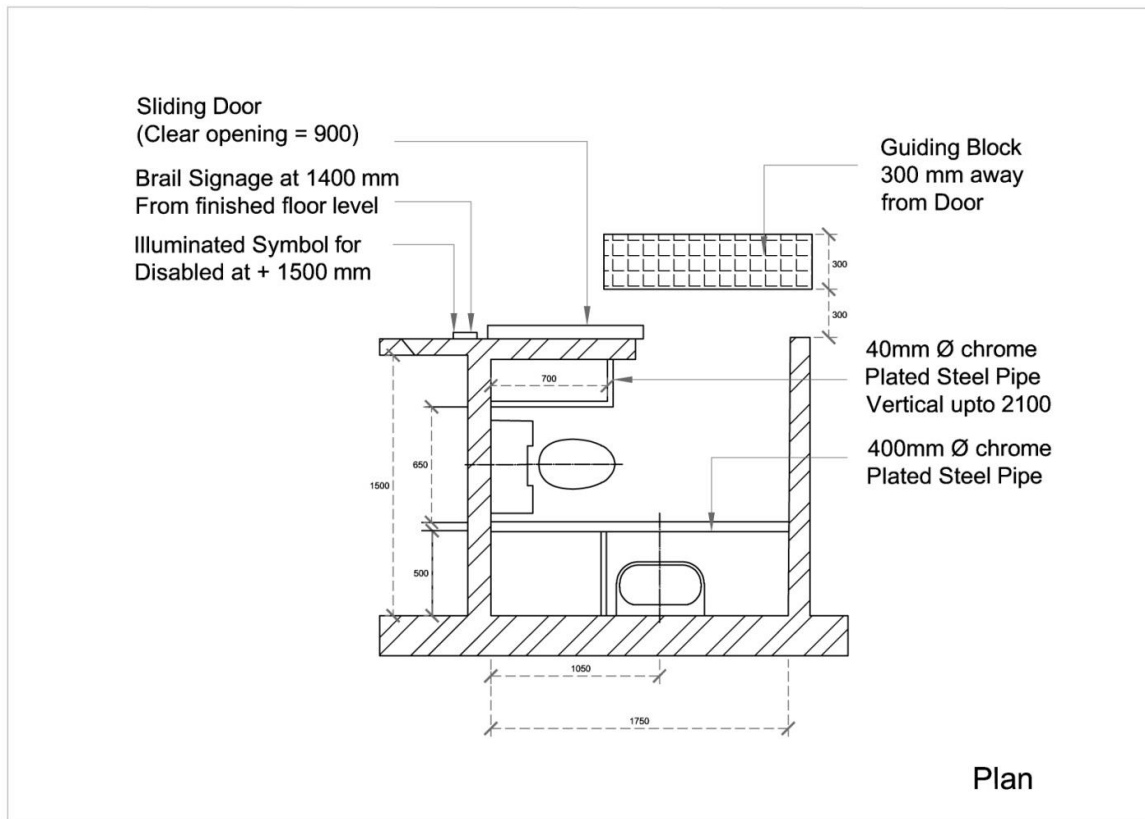

Figure No. 13.21: Typical Toilet Details

- 2 Water closets shall be provided for each gender. The dimensions and area of WC and Bathroom are given in Table No. 13.8 above.
- 3 The number of water closets shall be decided on the basis of the maximum number of building users by gender at any time and as specified in Table No. 13.9.

Table No. 13.9: Requirement of Sanitation

Building Use	Rate for No. of Users	No. of Users	Min. No. of Urinals	Min. No. of Water Closets	Min. No. of Washbasins or Wash area
(1)	(2)	(3)	(4)	(5)	(6)
Educational 1, 2 & 3	1 user per 1 sq m per carpet area		5 or 1 per 50 male users or less, whichever is more	2 or 1 per 200 users or less per gender, whichever is more	1 per 200 users
Mercantile 1, 2 & 3	1 user per 4 sq m per carpet area	<20	1 may be provided	1 WC per gender each	1 per WC
		21-100	1 per 25 male users or less	1 per 25 users or less per gender	1 per 50 users
		101-500	1 per 50 male users or less	1 per 50 users or less per gender	1 per 100 users
		>500		1 per 100 users or less per gender	1 per 200 users
Industrial 1, 2 & 3, Storage	1 user per 25 sq m of carpet area	1-100	1 per 100 male users or less	1 per 25 users or less per gender	1 per 50 users
		>100	1 per 50 male users or less	1 per 50 users or less per gender	1 per 100 users
Special Buildings	1 user per seat		2 per 75 users or less	1 per 100 users or less per gender	1 washbasin per 200 users or less

- 4 Minimum 25% of such water closets and urinals shall be provided in common and accessible locations of the building.

- 5 These sanitation facilities shall be provided with signage indicating the use and the intended users gender as per Rule No. 13.8.

13.8.3 For Special Buildings

The number of water closets shall be decided on the basis of the number of seats provided as indicated in Table No. 13.9. Water closets shall be provided for each gender, apportioned suitably.

13.9 Drainage

The manner in which it is intended to connect the drainage system of a building to a public sewer shall be subject to approval by the Competent Authority while granting development permission. Rules for construction, maintenance, and control of drains, sewers, drainage, and sewage works of any description within Development Area shall be as per the norms of Pollution Control Board.

1 Provision of Septic Tank, Soak Pit and Soak Well

In case where there is no drainage facility available for the land to be developed, the owner shall provide septic tank, soak pit or soak well for disposal of sewage and wastewater.

2 Location and Sub Soil Dispersion

A sub soil dispersion system shall not be closer than 12 m to any source of drinking water, such as a well, to mitigate the possibility of bacterial pollution of water supply. It shall also be as far removed from the nearest habitable building is economically feasible but not closer than 2 m to avoid damage to the structure.

3 Dimensions and Specifications

- a) Septic tank shall have a minimum inner width of 75 cm, a minimum depth of one meter below the water level and a per capita minimum liquid capacity of 120 litres. The length of the tanks shall be least twice the width.
- b) Septic tanks may be constructed of brick work, stone masonry, concrete, or other suitable material as approved by the Competent Authority.
- c) Under no circumstances should effluent from a septic tank or allowed into an open channel drain or body of water without adequate treatment.
- d) The minimum normal diameter of the pipe shall be 100 mm. Further at junction of pipes in manholes, the direction of flow from a branch connection should not make an angle exceeding 45 degrees with the direction of flow in the main pipe.
- e) The gradients of land-drains, under-drainage as well as the bottom of dispersion trenches and soak wells should be between 1:300 and 1:1400.
- f) Every septic tank shall be provided with a ventilating pipe of at least 50 mm diameter. The top of the pipe shall be provided with a suitable cage of mosquito proof wire mesh. The ventilating pipe shall extend to a height which would cause no smell or nuisance to any building in the area. Generally, the ventilating pipe should extend to a height of about 2 m above the septic tank if it is located within the proximity of 15 m of the building.
- g) When the disposal of a septic tank effluent is to a soak pit, the soak pit may be of sectional dimension of 90 cm and not less than 100 cm in depth below the inner level of the inlet pipe. The pit may be lined with stone, brick and concrete blocks with dry open joint which should be backed with at least 7.5 cm of clean coarse aggregate. The lining above the inlet level should be narrowed to reduce the size of the RCC cover slabs. Where no lining is used, especially near trees, the entire pit should be filled with loose stones. A masonry ring should be constructed at the top of the pit to prevent damage by flooding of the pit by surface run off. The inlet pipe should be taken down to a depth of 90cms from the top as an anti-mosquito measure.
- h) When the disposal of septic tank effluent is to a dispersion trench, the dispersion trench shall be 50 to 100 cm wide, excavated to a slight gradient and shall be provided with a layer of shed gravel or crushed stones 15 to 25 cm deep. Open, joined pipes placed inside the trench shall be made of unglazed earthenware clay or concrete and shall have a

minimum internal diameter or 70 to 100 mm. Each dispersion trench should not be longer than 30 m and trenches should not be placed closer than 1.8 m to each other.

- i) The above-mentioned Rules shall be subject to modification from time to time as required by Pollution Control Board/ Competent Authority.

13.10 Electrical Infrastructure

Adequate electrical infrastructure as published in the National Building Code of India, Part VIII - Building Services, Section 2- Electrical Installations, shall be provided in all buildings to the satisfaction of the Competent Authority.

13.11 Digital Communication Infrastructure

A broad variety of Information Communication Technology (ICT) systems are expected to be installed in buildings. In order to facilitate proper cabling and installation / up gradation of ICT systems and their cost effectiveness and maintenance, adequate physical infrastructure is required within buildings. This infrastructure will include common ducts, cable riser systems, conduits, cable trays and utility closets etc. among other things. The same can also be retrofitted into existing buildings wherever possible and feasible and must be designed in all new, re-developed and renovated structures. Sharing of in building infrastructure will save capex and opex, as well as avoid duplication of infrastructure deployment by multiple providers.

Provision for in buildings for 'Common Telecommunication Infrastructure' (CTI) is mandatory in Dwelling 3, Mercantile 2 & 3, Assembly 1, 2, 3 & 4, Hospitality 1, 2 & 3, Education 2 & 3, Health 1, 2, 3 & 4, Service Establishment 2, Industrial 1, 2 & 3, Transport, Storage and Public Offices etc.

CTI needs duct sharing and fibre sharing. It will need space and power for installation of common ducts, optical fibre, small cells, antennas, smart sensors etc. Earthing requirements may also be there for some ICT. In some cases, there may be more specific requirements for utility spaces such as:

- Cable routing layout and cable length restrictions between Workspace and utility closet.
- Bending radius and working clearance requirements for different cable types, e.g. Fiber optic cables, Cat-6 Cables and co-axial cables.
- Isolated power circuits for permanent communication equipment.
- Protection, Safety, Grounding, and environmental requirements of communication equipment.

13.11.1 Solutions for In-Buildings and Gated Buildings

- 1 The buildings are to be constructed in such a way that they are 'digital connectivity' ready. For this they need to provide common telecom ducts / pathways to reach accessible parts of the buildings. They should also have properly demarcated sections within buildings and on rooftops for housing broad band / digital connectivity infrastructure / antenna. These areas should have access to power supply for reliable, always-on services.
- 2 These common telecom ducts / pathways can be used/shared by various TSPs/IP-1s for laying / digital infrastructure including cables.
- 3 Further the TSPs/IP-1s shall be given unhindered access inside the buildings to install the telecom infrastructure / cables etc, as well as for their maintenance. This access can be free of charge or for a standardized nominal charge like other utilities.

13.11.2 Provisions at the Layout Level

- 1 While developing Greenfield cities/towns, the layout plans should clearly indicate the telecom as Utility infrastructure lines.
- 3 The placement and sequence of above and below-ground utilities at the appropriate location in the right-of-way shall be ensured for unconstrained movement as well as easy access for maintenance.

- 4 Telecommunication cables should be placed in a duct that can be accessed at frequent service points with sufficient spare capacity to enable scaling and future expansion, and empty pipes (large size hume pipes / HDPE pipes) should be laid before planting trees in order to accommodate additional infrastructure.
- 5 Telecommunication cables should ideally be placed below the parking area or service lane, which may be dug up easily without causing major inconvenience. Where this is not possible, the cables may be placed at the outer edge of the right-of-way.
- 6 There is a need to reduce conflicts with pedestrian movements is to place telecom boxes in easements just off the right-of-way. Where this is not possible, they should be placed within parking or landscaping areas. If cables have to be located in the pedestrian path, a space of at least 2m should be maintained for the through movement of pedestrians. Telecom boxes should never constrain the width of a cycle track.
- 7 To minimize disruptions, cables should be installed with proper maintenance infrastructure.

13.11.3 Provision of In Building Solution Components (as per NBC 2016)

- 1 Entrance Facilities (EF) /Lead-in conduits: (NBC 2016 Clause 3.1.4, of Part VIII: Sec 6) min. 1.2 m x 1.83 m space to be allocated for each TSP adjacent to the Entrance Facility.
- 2 Underground conduits/pipes to MDF room: min 100mm dia encased conduits.
- 3 Main Distribution Frame (MDF)/Equipment Room (ER):
(NBC 2016 Clause 3.1.2, Part VIII: Sec 6)
 - a) prescribed size with L:W ratio between 1:1 to 2:1
 - b) appropriate ventilation of MDF room
 - c) proper Lighting for vision of equipment.
 - d) located at a level above from the ground level to avoid incidence of flooding
- 4 Electric distribution panels, isolators, sockets and earthing as per specific requirements with respect to the area proposed for coverage (DUs/ service subscribers).
- 5 Telecommunications Room (TR) at each building block unless provided with MDF room (all provisions of space to be as per NBC 2016 Clause 3.1.3.2, Part VIII: Sec 6)
- 6 Appropriate nos. of Service / Telecom risers (vertical shafts) for all multi storeyed buildings w.r.t the area proposed for coverage (DUs/ service subscribers):
 - a) of appropriate numbers and size (width & depth) to accommodate cable trays
 - b) with access door at each floor.
- 7 Telecommunications Enclosures (TE) at each floor of a block or TR (NBC 2016 Clause 3.1.5, Part VIII: Sec 6).
- 8 Telecom Media and Connecting Hardware (TE) (NBC 2016 Clause 3.2, Part VIII: Sec 6)
- 9 Various cabling system and trays (NBC 2016 Clause 3.2.4, Part VIII: Sec 6)
- 10 Wireless systems (NBC 2016 Clause 3.2.5, Part VIII: Sec 6)
- 11 Backbone Cabling Media Distribution and Building pathways (NBC 2016 Clause 3.3, Part VIII: Sec 6)
- 12 Horizontal Cabling Media Distribution and Building pathways (NBC 2016 Clause 3.4, Part VIII: Sec 6)
- 13 IBS installation spaces: area for rooms or systems (eg., antennas, base stations, remote units, power distribution boxes etc.) to be provided as per requirements with respect to the area proposed for coverage/ no. of proposed users (NBC 2016 Clause 3.1.3.2, Part VIII: Sec 6 and Table No. 13.10 & 13.11)

Table No. 13.10: Telecom room space norm for buildings with Built-up area >465 sq m

No	Area to be covered by IBS	Size of Telecom Room (m)
1	Upto 465 sq m	3 x 2.4
2	465 sq m to 930 sq m	3 x 3.4
3	More than 930 sq m	Additional TR required with same space norms

Table No. 13.11: Space requirements for smaller buildings with Built-up area <465 sq m

No	Area to be covered by IBS	Space provisions (m)
1	Upto 93 sq m	Wall cabinets, self – contained enclosed cabinets
2	93 sq m to 465 sq m	Shallow Room (0.6 x 2.6)
		Walk-in Room (1.3 x 1.3)

IBS installation spaces, so provided, should be:

- 1 Not susceptible to flooding.
- 2 Not exposed to water, moisture, fumes, gases, or dust.
- 3 Able to withstand designed equipment load (to be specified in design)
- 4 Located away from any vibrations to avoid dislocation/dislodgement.

13.11.4 Process for obtaining IBS-NOC for Development permission and Occupancy Certificate

- 1 While submitting the application of development permission, the applicant shall also submit:
 - a) A complete Service Plan for IBS-infrastructure along with required specifications (in consultation with, and certified by a credible Telecom Networking hardware-consultant)
 - b) An undertaking that such IBS Infrastructure, when constructed shall be available for sharing by various TSPs/IP-Is.
- 2 Such Service Plan (IBS) shall be forwarded by the concerned Local Authority to the Telecom Enforcement Resource and Monitoring (TERM) cell of the State (external NOC agency) – for approval NOC.
- 3 During the Joint Site Inspection of the completed building structure the TERM cell shall undertake inspection of the constructed/installed IBS infrastructure – for issuance of NOC for OC.
- 4 The Competent Authority shall liaise with the TERM cell as per its relevant online/offline process of communication to seek the relevant NOCs within the specified time as per the Service Charter / Service Guarantee Act and rules in place. Separate communication from the applicant shall be needed to secure the IBS NOC.

13.12 Lifts and Elevators

13.12.1 For buildings exceeding 4 m height with following uses: Public Offices, Assembly, Educational 2, 3

Minimum one lift shall be provided to access public areas on floors above ground level.

13.12.2 For buildings exceeding 10 m height.

- 1 For buildings with height more than 10m, lifts shall be required as per the following Table No: 13.12.

Table No. 13.12: Provision for Passengers Lift

No.	Building Use	Height of Building	Minimum no. of Lifts (whichever is more from column A and B)	
			A	B
1	Dwelling 3	Above 10 m	Minimum 1, or	1 Lift per thirty dwelling units (Excluding dwelling units on ground level and two upper floors or hollow plinth and two upper floors)
		Above 25m	Minimum 2, or	
2	Non-residential	Above 10 m	Minimum 1, or	1 Lift per 1200 sq m built-up area (Excluding area on ground floor and two upper floors or hollow plinth and two upper floors)
		Above 25 m	Minimum 2, or	

No.	Building Use	Height of Building	Minimum no. of Lifts (whichever is more from column A and B)	
			A	B
<p>Note: If, DW 1 and DW 2 type building having building height up to & equal to 12 m from ground level then provision for requirement of lift shall not be applicable. The above shall also be confirmed with National Building Code of India, Part VIII - Building Services, Section 5- Installation of Lifts and Escalators. More stringent of both the provisions shall be adopted.</p>				

- 2 For buildings with height above 21 m, one of the required lifts shall be a fire lift, in conformity with as per Fire Rules in Part 3 (II) and amended from time to time.
- 3 For buildings having parking at other than ground floor and for accessibility ramp is not provided, in such cases building shall be provided with vehicular lift as per Table No.13.13. In addition to requirement of passenger lift as per Rule No. 13.12.2 (1 & 2) and Rule No. 13.12.3.

Table No.13.13: Size of Vehicle Lift shall be According to Weight of Car

No.	Use	Weight of Car / No. of Vehicle	Size (m x m)
(1)	(2)	(3)	(4)
1	Affordable Housing / Sparsh Housing / Chawls	3000Kg/2 nos. of car	3.80 x 6.45
2	Other than above	3000Kg/1.5 nos. of car	3.80 x 6.45
3	Non-Residential / Mix Use on other than up to first floor (other than Industries)	4 000 kg/2 Nos. of Car	4.30 x 6.95
<p>Note: Average vehicle occupancy may be considered as</p> <ul style="list-style-type: none"> - 1.5 per car for office car parks, - 4 for airports and retail and 2 elsewhere. <p>The above shall also be confirmed with National Building Code of India, Part VIII - Building Services, Section 5- Installation of Lifts and Escalators. More stringent of both the provisions shall be adopted.</p>			

- 4 Multi Level Car Parking
 - a) Number of car lifts ensuring that average car retrieval/parking time does not exceed 2 min.
 - b) The sizing of the car lifts has to be adequate to fit the largest vehicle that is intended to be transported as well as adequate space to enable opening of the doors to enable evacuation of passengers in the eventuality of an entrapment.
 - c) Designers will also need to take into account the probability of queues developing and provide for holding lanes as per Rule No.13.2.2.

13.12.3 General Requirements for Lifts and Elevators

- 1 Lift shall be provided from the ground level or lower level.
- 2 Minimum capacity of the lift shall be for six persons.
- 3 Lifts of either or 6, 8, 12 and/or 24 persons capacity can be permitted, as considered by Competent Authority as per the peak hour passenger volume. However more than 1 lift shall be provided as per Fire Rules in Part 3 (II) and amended from time to time.
- 4 A clear door opening with minimum width of 900 mm shall be provided. A clear landing area in front of the lift doors shall have minimum dimensions of 1.8 m x 2 m or more.
- 5 A handrail of 600 mm length shall be provided at a height of 1 m from the floor of the lift car.
- 6 The duration of an automatic closing lift door shall be minimum 5 seconds with a maximum closing speed of 0.25 m/sec.
- 7 The interior of the lift cabin shall be equipped with a device that audibly indicates the floor level reached and whether the door of the cabin is open or closed.

All lifts shall also meet Fire Rules in Part 3 (II) and amended from time to time.

13.13 External Façade

On the external façade of any building, the glazed surface area of the façade shall be non- reflective and provided up to a maximum of 50% of the total surface area of each façade, with the provision of safety railing up to sill level. On the North façade, entire surface area may be glazed. 10 degrees deviation may be permitted in consideration of the Northern façade (*Refer Figure No. 13.22*).

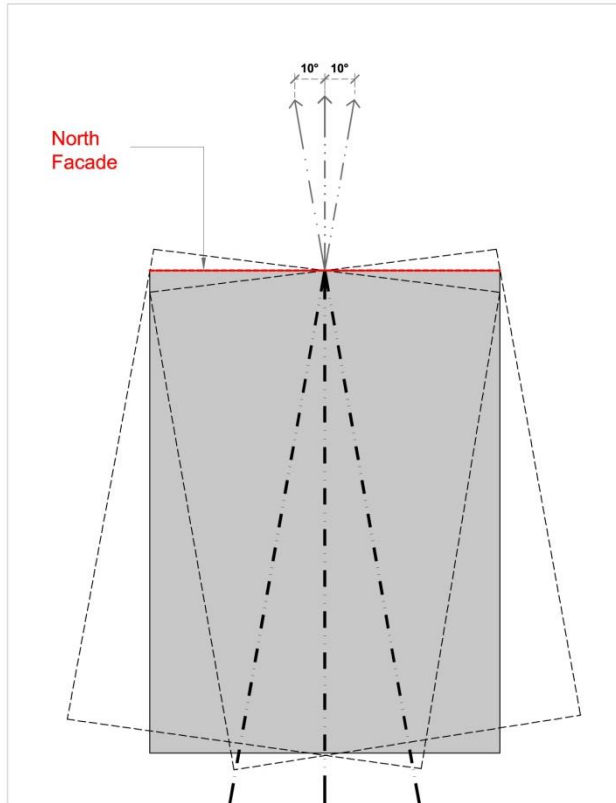

Figure No. 13.22: Details for External Façade

13.14 Occupant Load

- 1 The standard space and service requirements of various parts of a building like light and ventilation, fire safety etc., depend on the number of persons who would normally occupy the building. The occupant load therefore for any building should be worked out from Table No. 01 in Part 3 (II).
- 2 The plinth or covered area shall include, in addition to the main assembly room or space, any occupied connecting room or space in the same storey or in the storeys above or below where entrance is common to such rooms and space and the area available for use by the occupants of the assembly place. No deduction shall be made in the plinth/covered area for corridors, closets, and other sub-divisions; that area shall include all space serving the assembly occupancy.

14 Fire Prevention, Safety and Protection

Refer Part 3 (II).

15 Special Buildings

The following Rules shall be applicable for all Special Buildings in addition to the other Performance Rules.

15.1 Visibility

Auditoriums or cinema halls shall provide minimum visibility requirements as per following specifications:

- 1 The seat nearest to the screen shall not be nearer than the effective width of the normal picture (ratio 1:1.33). This distance shall be $\frac{3}{4}$ in case of cinema scope and other wide angles techniques and one half in case of 70 mm presentations.
- 2 The elevation of the balcony seats shall be such that line of sight is not inclined more than 30° to the horizontal.
- 3 The seats should preferably be staggered sideways in relation to those in front, so that a spectator in any row is not looking directly over the head of the person immediately in front of him.
- 4 The position and height of the screen shall be regulated in such a way that the maximum angle of the line of vision from the front seat to the top of the screen shall not exceed 50°.

15.2 Mixed Occupancy

- 1 Places of assembly in buildings of other occupancy, such as all rooms in hotels, restaurants, stores and assembly rooms in schools, shall be so located, separated, or protected as to avoid any undue danger to the occupants of the place of assembly from a fire / smoke originating in the other occupancy.
- 2 Every place of assembly, every tier of balcony, and every individual room used as a place of assembly shall have exits sufficient to provide for the total capacity therein as required such that door width for assembly building shall not be less than 2000 mm for every 600 persons.
- 3 Every place of assembly shall have at least four separate exits as remote from each other as practicable.
- 4 At least one row of seating area shall be made accessible by ramps or elevators for disabled visitors.
- 5 Clear aisles not less than 1.2 m in width shall be formed at right angles to the line of seating in such number and manner that no seat shall be more than seven seats away from an aisle. Rows of seats opening to an aisle at one end only shall have not more than seven seats. Under the condition, where all these aisles do not directly meet the exit doors, cross- aisles shall be provided parallel to the line of seating so as provide direct access to the exit, provided that not less than one cross aisle for every 10 rows shall be required. The width of cross-aisles shall be minimum of 1 m. Steps shall not be placed in aisles to overcome differences in levels unless gradient exceeds 1 in 10.
- 6 The fascia of boxes, balconies and galleries shall have substantial railings not less than 1000 mm high above the floor. The railings at the end of aisles extending to the fascia shall be not less than 1000 mm high for the width of the aisle or 1100 mm high at the foot of steps.
- 7 Cross aisles except where the back of seats on the front of the aisle project 600 mm or more above the floor of the aisle shall be provided with railings not less than 900 mm high.
- 8 No turnstiles or other devices to restrict the movement of persons shall be installed in any place of assembly in such a manner as to interfere in any way with the required exit facilities.
- 9 In theatres and similar places of public assembly where persons are admitted to the building at a time when seats are not available for them are allowed to wait in lobby or similar place until seats are available, such use of lobby or similar space shall not encroach upon the required clear width of exits. Such waiting shall be restricted to areas separated from the exit ways by substantial permanent partition or fixed rigid railing not less than 105 cm high. Exits shall be provided for such waiting spaces on the basis of 1 person for each 0.3 sq m of waiting space /

- area. Such exits shall be in addition to exits specified for the main auditorium area and shall conform in construction and arrangement to the general Rules of exits given above.
- 10 No display or exhibit shall be so installed or operated as to interfere in any way with access to any required exit, or with any required exit sign. All displays or exhibits of combustible material or construction and all booths and temporary constructions in connection therewith shall be so limited in combustibility or protected so as to avoid any undue hazard of fire which might endanger occupants before they have opportunity to use the available exits, as determined by the Competent Authority.
 - 11 Places of assembly in buildings of other occupancy may use exits common to the place of assembly and the other occupancy, provided the assembly area and the other occupancy are considered separately, and each has exits sufficient to meet the requirements of the code.
 - 12 Exits shall be sufficient for simultaneous occupancy of both the place of assembly and other parts of the building, unless authority determines that the simultaneous occupancy will not occur.
 - 13 At least half the required means of exit shall lead directly outdoors or through exit ways completely separated from exits serving other parts of the building.
 - 14 The decoration of place of assembly shall be of non-flammable materials. Fabrics and papers used for such purpose shall be treated with an effective flame-retardant material. Stage settings made of combustible materials shall likewise be treated with fire retardant materials of class 1 flame spread.
 - 15 Seats in places of public assembly, accommodating more than 300 persons, shall be securely fastened to the floor except as permitted in (16) below. All seats in balconies and galleries shall be securely fastened to the floor, except that in nailed-in enclosures like boxes with level floors and having not more than 14 seats, the seats need not be fastened. Tapestry of the seats shall be fire resistant.
 - 16 Chairs not secured to the floor may be permitted in restaurants, night clubs and other occupancies where fastening of seats to the floor may not be practicable, provided that in the area used for seating, excluding dance floor, stage etc, there shall be not more than one seat for each 1.4 sq m of floor area and adequate aisles to reach exits shall be maintained at all times.
 - 17 Seats without dividing arms shall have their capacity determined by allowing 45 cm per person.
 - 18 The spacing of rows of seats from back shall neither be less than 85 cm nor less than 70 cm plus the sum of the thickness of the back and the inclination of the back. There shall be a space of at least 350 mm between the back of one seat and the front of the seat immediately behind it as measured between plumb lines.
 - 19 Rooms containing high-pressure boilers, refrigerating machinery other than domestic refrigerator type, or other service equipment subject to possible explosion shall not be located directly under or adjacent to required exits. All such rooms shall be effectively cut off from other parts of the building and provided with adequate vents to the outer air.
 - 20 All rooms or areas used for storage of any combustible material or equipment, or for painting, refinishing, repair or similar purposes shall be effectively cut off from assembly areas or protected with a standard system of automatic sprinklers. They shall be located away from staircases.
 - 21 Every stage equipped with fly galleries, grid irons and rigging for movable theatre type scenery shall have a system of automatic sprinklers over and under such stage areas or spaces and auxiliary spaces, such as dressing rooms, storerooms, and workshops. The proscenium opening shall be provided with a fire-resisting curtain, capable of withstanding a lateral pressure of 4 KN/ sq m over the entire area. The curtain shall have an emergency closing device capable of causing the curtain to close without the use of power and when so closed, it shall be reasonably tight against the passage of smoke.
 - 22 The stage roof of every theatre using movable scenery or having a motion picture screen of highly combustible construction shall have a ventilator or ventilators in or above it, openable from the stage floor by hand and also opening by fusible links or some other approved automatic heat/ smoke actuated device, to give a free opening equal to at least one-eighth the area of the floor of the stage.

- 23 The proscenium wall of every theatre using movable scenery or decorations shall have exclusive of the proscenium opening, not more than two openings entering the stage, each not to exceed 2 sq m and fitted with self-closing fire-resistant doors.
- 24 Automatic smoke vents actuated by smoke detectors shall be installed above the auditorium or theatres, including motion picture houses, with capacity of 8 air change per hour.

15.3 Public Offices / Hospital Buildings

These shall conform to 6.3 Part IV National Building Code, amended from time to time and particular attention is drawn to the following:

- 1 In building or sections occupied by bed ridden patients where the floor area is over 280 sq m, facilities shall be provided to move patients in hospital beds to the other side of a smoke barrier from any part of such building or section not directly served by approved horizontal exits or exits from first floor (floor 2) of a building to the outside.
2. Not less than two exits of one or more of the following types shall be provided for every floor, including basements, of every building or section:
 - a Doors leading directly outside the building.
 - b Stairways
 - c Ramps
 - d Horizontal Exits and
 - e Fire Escape Staircase
- 3 All required exits as per Table in Rule No. 22.4 of corridor width.
- 4 No building constructed in whole or in part of combustible materials shall be used to confine inmates in cells or sleeping quarters unless automatic sprinkler protection is provided.

15.4 Public Safety

Closed Circuit Television (CCTV) Network shall be installed in public areas of assembly buildings and other places of entertainment as per protocols laid down by the Competent Authority.

16 Structural Safety

16.1 Applicability

The following structural and seismic safety Rules shall apply to all buildings as per Schedule No. 10.

16.2 Structural Stability and Maintenance of Existing Buildings

- 1 The owner / developer / occupants and registered appointed Persons on Record shall carry out the assessment of structural safety of an existing building at stipulated periodical intervals through expert(s) chosen from a panel of experts identified by the Competent Authority. The intervals for maintenance and inspection shall be as per Schedule No. 10.
- 2 The owner / developer / occupant on advice of such expert(s) shall carry out such repair / restoration and strengthening / retrofitting of the building found necessary so as to comply with the safety standards laid down in The National Building Code and the Indian standards as specified.
- 3 In case the owner / developer / occupant does not obtain certificate of structural fitness of the building for the sanctioned use from authorized person having expertise as per stipulated timelines, the Competent Authority may take befitting action to discontinue the use of the building.
- 4 The Competent Authority may also direct the owner / developer / occupant, whether the building could be occupied or not during the period of compliance.

16.3 Additions and Alterations to Existing Buildings

An alteration or addition to an existing building that is not structurally independent shall be designed and constructed such that the entire structure conforms to the structural and seismic safety requirements for new buildings, unless the following three conditions are complied with:

- 1 The alteration or addition complies with the requirements for new buildings.
- 2 The alteration or addition does not increase the seismic forces in any structural element of the existing building by more than 5% unless the capacity of the element subject to the increased force is still in compliance with the requirements for new buildings.
- 3 The alteration or addition does not decrease the seismic resistance of any structural element of the existing building unless the reduced resistance is equal to, or greater than, that required for new buildings.

16.4 Change of Use of Building or Part of a Building

When a change of use results in a structure being reclassified to a Higher Importance Factor (I) as defined in the IS: 1893-2002 "Criteria for Earthquake Resistant Design of Structures (Fifth Revision)", the building shall conform to seismic requirements for a new building with the Higher Importance Factor.

16.5 Structural Safety Provision during Construction

- 1 The quality of all materials and workmanship shall conform to accepted standards and Indian Standard Specifications and Codes as included in Part V: Building Materials and Part VII Constructional Practices and Safety, National Building Code of India.
- 2 All borrow pits dug in the course of construction and repair of buildings, embankments, etc., shall be deep and connected with each other in the formation of a drain directed towards the lowest level and properly stepped for discharge into a river, stream, channel or drain, and no person shall create any isolated borrow pit which is likely to cause accumulation of water that may breed mosquitoes.

- 3 Alternative materials, method of design and construction and tests: The provisions of the Rules are not intended to prevent the use of any material or method of design of construction not specifically prescribed in them provided any such alternative has been approved. Nothing of the provisions of these Rules is intended to prevent the adoption or architectural planning and layout conceived as an integrated development scheme. The Competent Authority may approve any such alternative if it conforms to the provisions of the relevant parts of the National Building Code, regarding material, design and construction, and the material, method, or work offered is, for the purpose intended, at least equivalent to that prescribed in these Rules in quality, strength, compatibility, effectiveness, fire and water resistance, durability, and safety.
- 4 All buildings shall be constructed on quality control requirements.
- 5 In case of buildings under construction based on approved development permission, structural safety requirements shall have to be observed. However, due to such structural work of strengthening / retrofitting in the event of natural disaster if certain setbacks and margin get reduced, special permission may be granted by the Competent Authority on case-to-case basis.

16.6 Structural Safety Tests for Special Buildings

Whenever as per an opinion of panel experts, there is insufficient evidence of compliance with the provisions of the Rules or evidence that any material or method of design or construction does not conform to the requirements of the Rules, in order to substantiate claims for alternative materials, design or methods of construction, the Competent Authority may require tests, sufficiently in advance, as proof of compliance. These tests shall be made by an approved agency at the expense of the owner as follows:

- 1 Test Methods: Test methods shall be as specified by the Rules for the materials or design or construction in question. If there are no appropriate test methods specified in the Rules, the competent authority shall determine the test procedure. For methods or tests for building materials, reference shall be made to the relevant Indian standards as given in the National Building Code of India published by the Bureau of Indian Standards.
- 2 Test result to be preserved: Copies of the result of all such tests shall be retained by the Competent Authority for not less than two years after the acceptance of the alternative material
 - a) The testing of the materials as per Indian standards shall be carried out by laboratories approved by the Competent Authority on this behalf.
 - b) The laboratory/agency shall work out in consultation with the construction agency a testing programme of materials such as cement, steel and quality of concrete including its mixing, laying and strength at site as well as in the laboratory.
 - c) This should cover various stages of construction from foundation to completion as per Rule. The laboratory shall maintain a duly authenticated report in a bound register, copy of which will be submitted to the construction agency, which will in turn forward the testing report to the Competent Authority.

16.7 Design for Structural and Seismic Safety

16.7.1 Design Standards

In addition to the any other law for the time being in force, the structural design of foundations, elements of masonry, timber, plain concrete, reinforced concrete, pre-stressed concrete, and structural steel shall conform to:

- 1 The provisions of the National Building Code of India second revision, Part VI - Structural Design (Section – 1 Loads, Section – 2 Foundation, Section – 3 Wood, Section – 4 Masonry, Section – 5 Concrete and Section – 6 Steel), and as amended from time to time and,
- 2 The following Indian Standards:

Structural Safety:

- 1 IS: 456: 2000 "Code of Practice for Plain and Reinforced Concrete"
- 2 IS: 800: 1984 "Code of Practice for General Construction in Steel"
- 3 IS 875 (Part 2): 1987 "Design loads (other than earthquake) for buildings and structures"
Part 2 Imposed Loads
- 4 IS 875 (Part 3): 1987 "Design loads (other than earthquake) for buildings and structures"
Part 3 Wind Loads
- 5 IS: 883: 1966 "Code of Practice for Design of Structural Timber in Building"
- 6 IS: 1904: 1987 "Code of Practice for Structural Safety of Buildings: Foundation"
- 7 IS1905: 1987 "Code of Practice for Structural Safety of Buildings: Masonry Walls"

Seismic Safety

- 1 IS: 1893-2002 "Criteria for Earthquake Resistant Design of Structures (Fifth Revision)"
- 2 IS:13920-1993 "Ductile Detailing of Reinforced Concrete Structures subjected to Seismic Forces - Code of Practice".
- 3 IS:4326-1993 "Earthquake Resistant Design and Construction of Buildings - Code of Practice (Second Revision)"
- 4 IS:13828-1993 "Improving Earthquake Resistance of Low Strength Masonry Buildings - Guidelines"
- 5 IS:13827-1993 "Improving Earthquake Resistance of Earthen Buildings - Guidelines"
- 6 IS:13935-1993 "Repair and Seismic Strengthening of Buildings - Guidelines"
- 7 "Guidelines for Improving Earthquake Resistance of Buildings", by Expert Group, Government of India, Ministry of Urban Affairs & Employment, published by Building Materials and Technology Promotion Council, 1998.
- 8 In pursuance of the above, a certificate as indicated in Form 2A shall be submitted along with building plans/ drawings and other building information schedule annexed thereto.

Cyclone/ Windstorms:

- 1 IS 875 (3): 1987 "Code of Practice for Design Loads (other than Earthquake) for Buildings and Structures, Part 3, Wind Loads"
- 2 "Guidelines (based on IS 875 (3): 1987) for Improving the Cyclonic Resistance of Low-rise Houses and Other Building", by Expert Group, Government of India, Ministry of Urban Affairs & Employment, published by Building Materials and Technology Promotion Council, 1998.

Note: Wherever an Indian Standard including those referred to in the National Building Code or the National Building Code is referred, the latest revision of the same shall be followed except specific criteria, if any, mentioned above against that Code. All Standards applicable as amended from time to time by Competent Authority.

16.7.2 Structural Inspection Report

A Structural Inspection Report (SIR) shall be prepared for all buildings specified in Schedule No. 10 and submitted as specified in Form No. 26.

16.8 Structural Safety of Display Structure

Every display structure such as billboard / hoarding shall be designed to ensure safety and shall be installed in compliance with the National Building Code.

17 Environmental Management / Sustainability

17.1 Minimum Distance from Water Body and Water Course

- 1 Minimum clearance of 15 m shall be provided between the boundary of the bank of a river where there is no embankment and any development work or part thereof (*Refer Figure No. 17.1*).

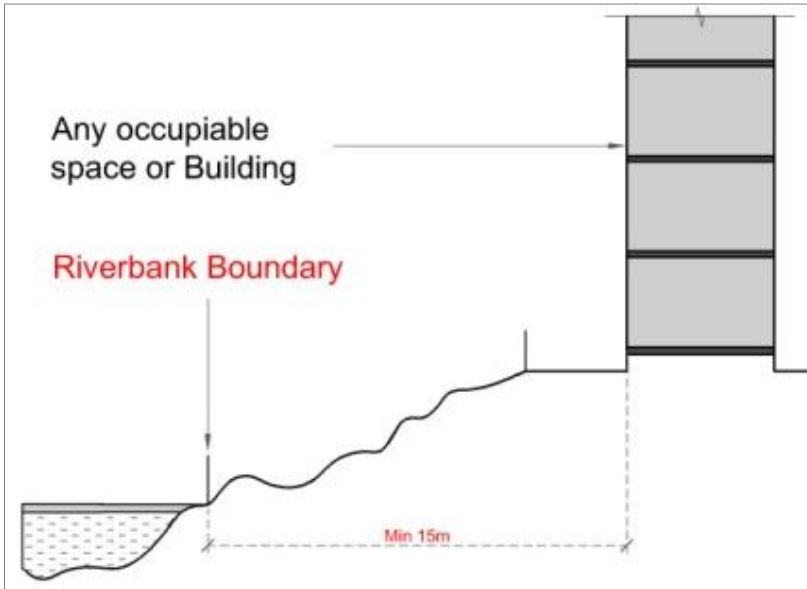

Figure No. 17.1: Minimum Distance of Water Body and Water Course from Riverbank Boundary

- 2 Minimum clearance of 10 m to be provided between the embankment of a river and any building or part thereof or any other clearance as may be prescribed under any other general or specific orders of Government and Competent Authority whichever is more (*Refer Figure No. 17.2*).

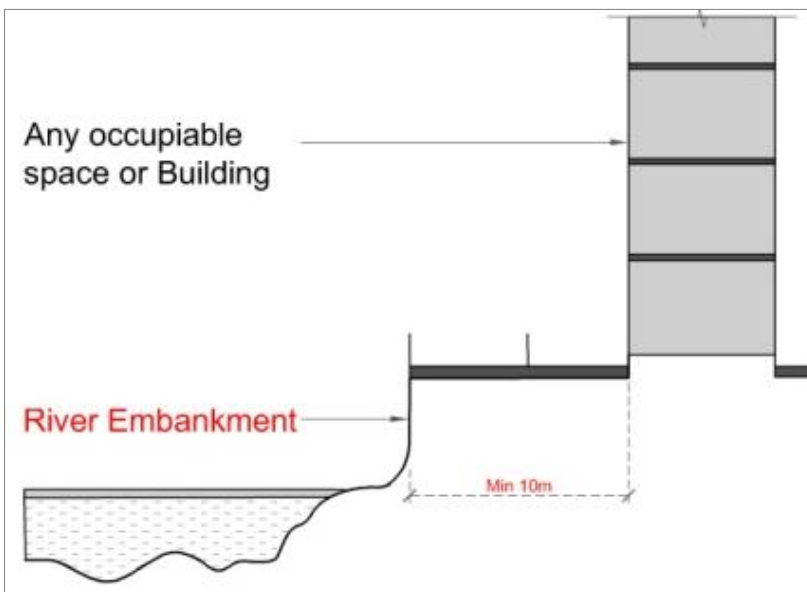

Figure No. 17.2: Minimum Distance of Water Body and Water Course from River Embankment

- 3 Minimum clearances of 6 m shall be provided between the boundary of any other waterbody / water course such as lake, talav, pond, canal, nala, kotar (perineal / non perineal), and any building or part thereof (*Refer Figure No. 17.3*).

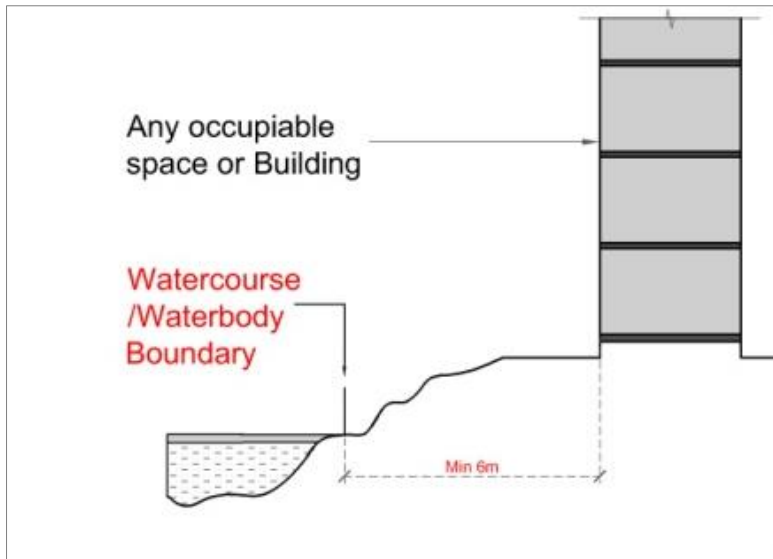

Figure No. 17.3: Minimum Distance of Water Body and Water Course from Watercourse/Water Boundary (Right)

- 4 Where a water course passes through a low-lying land without any well-defined bank, the applicant may be permitted by the Competent Authority to restrict or re-direct the water course to an alignment and cross-section determined by the Competent Authority.

17.2 Rainwater Management

17.2.1 Rainwater Disposal

- 1 The roof (terrace) of a building and the remaining area of the building unit shall be provided with an effective rainwater drainage system so as to ensure that the rainwater is not discharged into adjacent building units and no dampness is caused in any walls or foundation of adjacent buildings.
- 2 Rainwater pipes shall be affixed to the outside of the walls of the building or in recesses or formed in such walls or in such other manner as may be approved by the Competent Authority.
- 3 No roof or terrace abutting on a public street shall be constructed without providing sufficient number of down take pipes and such pipes shall be so fixed as to discharge the rainwater at a level not higher than 0.6 m above the street level.
- 4 The manner of channelling rainwater discharge from a building unit to a public storm water drain, if available, shall be determined by the Competent Authority.

17.2.2 Rainwater Harvesting

Rainwater harvesting refers to collecting / capturing the runoff from the roofs / terraces and open areas of the building unit for 1) storing it for future use, and 2) using it to recharge the underground water aquifers.

1 Rainwater Storage

Rainwater storage is mandatory for all building units having an area of 100 sq m and above. Rainwater storage tank of adequate capacity shall be constructed in marginal open space such that rainwater from the roof and plot drains into it. The water may be used for household uses such as washing, cleaning, and gardening.

2 Ground Water Recharge

Ground water recharge is mandatory for all building units having an area above 100 sq m. It shall be provided for as follows:

- a) For building units / plots having area 100 sq m and above and up to 500 sq m
Percolation pit or bore recharge shall be provided in the marginal space around the building. Such pits shall be filled with small pebbles, brick jelly or river sand and covered with perforated concrete slabs (Refer Figure No. 17.4).

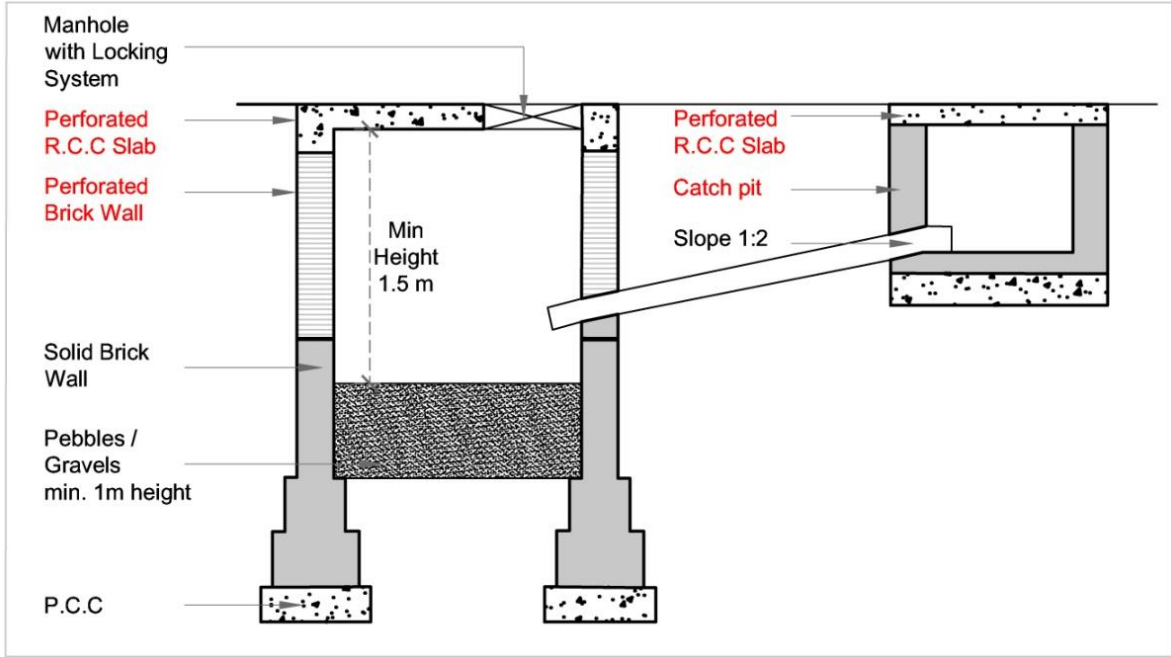

Figure No. 17.4: Percolation Pit or Bore Recharge

- b) For building units having area above 500 sq m and up to 1500 sq m:
Percolating well with rainwater harvesting system shall be provided (Refer Figure No. 17.5-Left Image) (up to first ground aquifer).
- c) For building units having area above 1500 sq m and up to 4000 sq m
Percolating well with rainwater harvesting system shall be provided (Refer Figure No. 17.5-Right Image) (up to second ground aquifer).

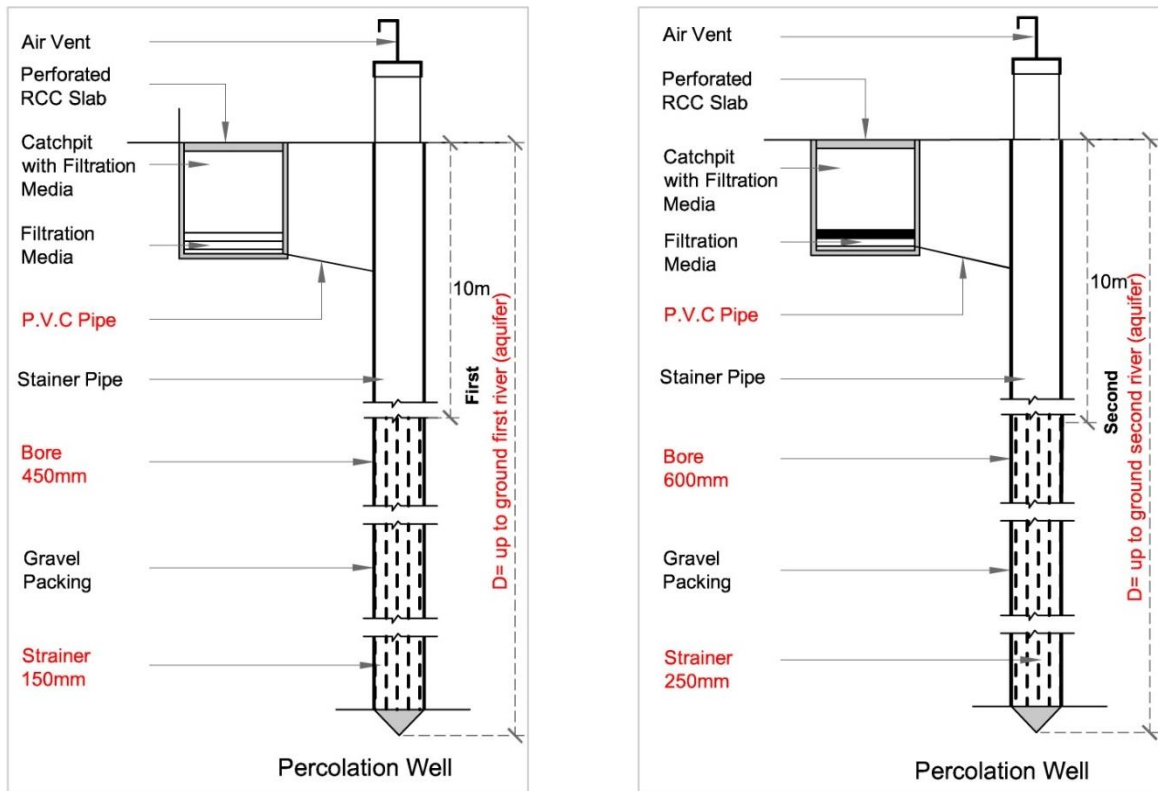

Figure No. 17.5: Percolation Well with Rainwater Harvesting System upto Ground First River (Left) and upto Ground Second River (Right)

- d) For buildings with building unit area above 4000 sq m
One percolating well shall be provided as per Rule No. 17.2.2(c) for every 4000 sq m land area. As an alternative to providing multiple percolating wells, a water retention pond with minimum capacity of 300,000 litres with a percolating well for every five percolating wells or part thereof shall be permitted.

17.2.3 Open Spaces within Layouts

All open spaces / common plots that is provided must be provided with ground water recharge wells. The gradients must be such that the runoff from the layout leads towards these.

17.2.4 Public Open Spaces

All public parks, gardens, water bodies must be provided with ground water recharge wells.

17.3 Solid Waste Management

All buildings shall provide facilities for solid waste management with segregation of dry and wet waste at source. Standards and specifications of facilities shall conform to the following requirements:

17.3.1 Solid Waste Bin for Residential Use

- 1 Separate collection bins for dry and wet waste shall be provided in the premises of every residential building which shall be placed at a location where they can be easily picked by waste collection vehicle of the local authorities.
- 2 The size of the bin container shall be calculated at the rate of 10 liters capacity per dwelling unit with a maximum size of bin of 80 liters. The numbers of bins shall be calculated on the basis of total number of dwelling units / tenements.

17.3.2 Solid Waste Bin for Non-Residential Use

- 1 Separate collection bins for dry and wet waste shall be provided in the premises of every non-residential building which shall be placed at a location where they can be easily picked by waste collection vehicle of the local authorities.
- 2 The size of the bin container shall be calculated at the rate of 20 liters capacity per 100 sq m of floor area with a maximum size of bin of 80 liters.
- 3 For hospitals, hotels and restaurant, disposal of solid waste shall be carried out as per the applicable rules and byelaws made by any authority.
- 4 For clubs, community halls and party plots, garbage containers for dry and wet waste shall be provided as per the rules and bye laws of the local authority. In absence of any such direction, the bins shall be of such size and placed as such location as may be decided by the competent authority from time to time.

17.4 Grey Water Recycling**17.4.1 Applicability**

Any owner / developer shall make provision for reuse of recycled water when applying for approval for -

- 1 new construction of development with 100 dwelling units or more.
- 2 new set of buildings for categories with total built up area mentioned in Table No.17.1 below:

Table No.17.1: Reuse of Recycled Water

No.	Building Use	Built up Area (sq m)
(1)	(2)	(3)
1	Health 1, 2, 3 and 4	More than 5,000
2	Hospitality 1, 2 and 3	
3	Hostels for Schools, Colleges, Training Centres etc	More than 10,000
4	Community Centre, Banquet Halls, and similar uses	
5	Mercantile 1, 2 and 3	
6	All hazardous, water-polluting, chemical industries	

17.4.3 Provisions of Recycling System

The applicant shall along with his application submit the designs, plans, calculations, and the references used for the calculations etc to provide the system to recycle the grey water. Such system shall include the provisions to facilitate the following:

- 1 Separate plumbing/collection systems for collecting wastewater from toilets/WCs and wastewater from bathrooms & kitchens. Wastewater from WCs shall be let into the sewerage system / septic tanks. Wastewater / grey water from bathrooms and kitchens shall be treated within the premises and recycled – used for non-potable uses such as maintaining gardens, irrigation, vehicle washing, water closets, ground water recharge etc.
- 2 The grey water will be taken to a storage tank which may be provided in the marginal open space. Next to it a grey water treatment plant shall be provided / installed to enable treatment of the grey water. The treatment facility shall not constitute a nuisance of foul gases or cause public hazard or not comply with any other Rules.
- 3 Treated grey water shall be pumped and stored into a separate tank on the roof from where it may be supplied to WCs, garden taps, common taps for car washing, cleaning premises etc. The down take pipes for the recycled water shall be distinguished by purple-coloured pipes.
- 4 It shall be ensured that there is no connection between the potable water plumbing system and recycled water plumbing system to avoid contamination.
- 5 The treated water quality shall conform to standards of non-potable water. The recycled water shall be tested once in six months and results shall be made available to Competent Authority whenever demanded.

- 6 To enable use of treated grey water in WCs, it shall be mandatory to provide double button cistern (dual flush tank.).
- 7 Arrangements for diverting excess grey water to the sewerage system of the local authority / septic tanks shall also be provided.
- 8 Arrangements for diverting the excess treated grey water into the storm water system of the local authority shall be made and treated grey water may be diverted into this, provided it is on accepted quality as mentioned in Rules of Competent Authority.

17.4.4 Quality of Water and Treatment

- 1 The water generated after treatment should be safe for its use for flushing toilets, gardening etc.
- 2 The company or the agency engaged for installation of system for recycling of wastewater shall preferably confirm ISO:14000.
- 3 Water quality from the Grey Water Recycling plants shall be as approved by the Pollution Control Board.
- 4 Provision may be made for checking the quality of recycled water with water testing laboratory with Municipal Council / Pollution Control Board / Competent Authority.
- 5 The testing of wastes and the submission of the results shall be done in a manner in accordance with the terms and conditions prescribed by Pollution Control Board / Competent authority.

17.4.5 General Provisions

- 1 Mandatory disclosure regarding changes:
An occupier of premises shall inform the Competent Authority of any change in the quality, nature or quality of the wastes discharged from his / her plant or premises and / or the manner of their discharge of water, immediately, if the change is likely to cause discharge of water in variation or violation of license under these Rules.
- 2 Corrective action:
In the event it is found if any person is violating the provisions of these Rules, the Competent Authority or Pollution Control Board shall issue notice, and after inquiry and personal hearing, take necessary corrective action.
- 3 Dispute Resolution:
All the disputes arising in the enforcement of these Rules shall be referred to Competent Authority who in turn will resolve the disputes in advice with his authorized technical officer or any experts and intimate to the occupier / owner/ developer. The decision of the Competent Authority will be final and binding on the occupier.
- 4 Authorized Laboratories:
List of these shall be authorized by Pollution Control board or the Municipal Council.

17.4.6 Enforcement of Rules

- 1 In case of proposed / intending / under redevelopment properties, the occupier / developer / owner will submit an application to the Competent Authority with details of proposed grey water reuse system along with the application for demand of water permission to connect the grey water / sewage to local government sewerage system. Before the grant of final Occupancy Certificate, the developer shall have to produce permission to connect his sewerage system to sewerage network of the city
- 2 Conditional Waste Discharge Permission – waste discharges of the conditional type of plant will be allowed, on the issue of a conditional permission, provided the conditional type of plant has recycling and reuse of water facility and not exceeding limits as per Pollution Control Board norms.

17.5 Tree Plantation

Tree plantation to be provided as per following:

- 1 Building unit / plot having area of more than 100 sq m shall be provided with minimum four trees and further for every 200 sq m area or part thereof, upto 500 sq m of area, minimum four

- trees, and beyond that for every 200 sq m area or part thereof minimum five trees shall be provided.
- 2 The trees shall preferably be shade giving and from the species listed in Schedule No. 12.
 - 3 The requirement of trees shall be reduced on the basis of the number of grown existing trees that are conserved and not affected by the proposed development.
 - 4 Trees shall be planted on site and guarded by the tree guards and shall be maintained properly.
 - 5 Trees shall be planted without causing obstruction to the easy movement of fire fighting vehicles in case of fire emergency.
 - 6 A fees for tree plantation are listed in Schedule No. 5A while applying for any development permission.
 - 7 Competent Authority may consult Forest Department for tree typology, plantation, and maintenance, etc. if required.

17.6 Solar Energy Systems

Solar energy system provisions shall be made for meeting the requirements of hot water and electricity generation.

17.6.1 Solar Water Heating System

All buildings in the following categories of uses shall provide solar assisted water heating systems:

Table No.17.2: Building Use Categories and Built-up Area for Provision of Solar Water Heating

No.	Building Use	Built-up Area
(1)	(2)	(3)
1	Bedded Hospitals and Nursing Homes	Irrespective to built up area.
2	Hospitality: Hotels, Lodges, Guest houses	More than 1000 sq m
3	Hostels for Schools, Colleges, Training Centres	
4	Community Centre, Banquet Halls, and similar uses	
5	Residential – detached and semi-detached dwelling units	More than 200 sq m of individual dwelling unit area

17.6.2 Roof Top Solar Energy Installations and Generation

All buildings in the following categories of uses shall provide roof top solar energy installations and generation:

Table No 17.3: Norms for Roof Top Solar PV Installation and Generation

No.	Category of building/ area	Area Standards	Generation Requirement*	Solar Panel Coverage
1	Dwelling 1 & 2	Plot Size of 500 sq m and above	Minimum 3 KWp	Maximum 70% of the roof area**
2	Dwelling 3	All proposals	Lighting and Ventilation of Staircase, Driveways, Parking, Common Corridors, Lift lobby, Setback areas and roof should be covered through Solar energy	Minimum 30% of the roof area should be utilized for solar energy
3	Education 1, 2 & 3 Public Office Health 1, 2, 3 & 4 Industrial 1, 2, & 3 Mercantile 1, 2 & 3 Recreational 1 & 2	Plot Size of 1000 sq m and above And Rooftop shadow free area greater than 50 sq m	All the common areas Lighting and Ventilation of Staircase, Driveways, Parking, Common Corridors, Lift lobby, Setback areas and roof should be covered through	Minimum 30% of the roof area should be utilized for solar energy

No.	Category of building/ area	Area Standards	Generation Requirement*	Solar Panel Coverage
			Solar energy	

*Area provisions on roof top shall be @12 sq m per 1KWp, as suggested by Ministry of New and Renewable Energy (Solar Rooftop System).

**“available roof area” = 70 % of the total roof size, considering 30 % area reserved for residents’ amenities.

17.7 Energy Efficient Buildings

Any owner or developer, who constructs energy efficient buildings and gets a certificate indicating the rating, from GRIHA (Green Rating for Integrated Habitat Assessment) / IGBC (Indian Green Building Council) or any other Government recognised Institute, shall be eligible for an incentive. Based on the rating certificate, the Competent Authority may offer 5% discount in the rate of chargeable FSI for the energy efficient buildings / Green Buildings on the total payable amount.

The owner shall have to apply prior to commencement of the project to GRIHA / IGBC for the rating certificate and registration. This shall be indicated in the development permission application.

17.8 Energy Conservation Code Compliant Buildings

- 1 Buildings or building complexes that have a connected load of 50 kW or greater or a contract demand of 60 kVA or greater and are intended to be used for commercial purposes must comply with the latest version of Dadra & Nagar Haveli and Daman & Diu Energy Conservation Building Code (ECBC). Buildings intended for private residential purposes only are not covered by the Code.
- 2 For this clause, a building is classified as “Commercial”, if it is used for any of the following purposes:
 - a) Hospitality: Star Hotel, No Star Hotel & Resort
 - b) Educational: College, University, Institution & School
 - c) Health Care: Hospital & Out-patient, Healthcare
 - d) Shopping Complex: Shopping mall, Stand-alone retails, Open Gallery Malls & Super Markets
 - e) Business: Daytime Use & 24-hours use
 - f) Assembly: Multiplex, Theatre & Building used for Transport Services.
- 3 The applicable building systems under the latest version of Dadra & Nagar Haveli and Daman & Diu Energy Conservation Building Code (ECBC) are:
 - a) Building envelope
 - b) Mechanical systems and equipment, including heating, ventilating, and air conditioning, service hot water heating
 - c) Interior and exterior lighting, and
 - d) Electrical power and motors, and renewable energy systems.

The provisions of this code do not apply to plug loads, and equipment and parts of buildings that use energy for manufacturing processes, unless otherwise specified in the Code.
- 4 The compliance of energy performance of a building with the latest version of Dadra & Nagar Haveli and Daman & Diu Energy Conservation Building Code (ECBC) shall be ensured by the owner by following the mandatory requirements of the code and by following either Prescriptive Method, Building Envelope Trade-off Method or Whole Building Performance Method specified in the Dadra & Nagar Haveli and Daman & Diu Energy Conservation Building Code (ECBC).

17.9 Environment Impact Assessment

No development permission shall be given to the building and construction projects, townships and area development project until getting Environment Clearance from SEIAA (State Level Environment Impact Assessment Authority) as required under the Environmental Impact Assessment Notification, 2006 as amended from time to time.

18 Pollution Control

18.1 Air Pollution

All buildings shall conform to provisions of Air (Prevention and Control of Pollution) Act, 1981, amended from time to time.

18.2 Water Pollution

All buildings shall conform to provisions of Water (Prevention and Control of Pollution) Act, 1974, amended from time to time.

18.3 Noise Pollution

All buildings shall maintain ambient air quality standards in respect of noise, as prescribed in the Noise Pollution (Regulation and Control) Rules, 2000, amended from time to time.

18.4 Industrial Pollution

No industrial effluent shall be disposed or exposed so as to cause nuisance and endanger to public health and shall not be disposed in a water body of any kind.

Without prejudice to the generality of the above provisions, the Competent Authority may stipulate certain conditions or measures to control the air borne emissions and liquid effluents from industrial units. These measures shall be stipulated as conditions of the building permission.

Any industry which emits liquid and gaseous effluents shall not be allowed to emit such effluent unless they are purified and rendered harmless from the public health point of view by provision of purification plants, as may be prescribed by the Competent Authority and / or the Pollution Control Board. And if any industry start emits effluents in future, then it shall be violation of Development Permission.

19 Maintenance and Upgradation

19.1 Maintenance of Buildings

19.1.1 Responsibility for Maintenance of Buildings

It shall be the responsibility of the owner of a building to ensure that the building is kept in good state of repair, such that its structural stability is not compromised.

19.1.2 Periodic Inspection and Maintenance Certificate

The intervals for maintenance and inspection for different types of buildings shall be as per Schedule No. 10.

The inspection shall be carried out by a SEOR to ascertain that the building's structural stability has not been compromised due to lack of adequate maintenance along with a Structural Inspection Report.

It shall be the responsibility of the owner to submit the Structural Inspection Report to the Competent Authority no later than one month after the date on which inspection is due.

19.2 Maintenance of Lifts and Escalators

19.2.1 Responsibility for Maintenance of Lift and Escalators

It shall be the responsibility of the owner of a building to ensure that lifts and escalators in the building are kept in good working condition and state of repair, such that their use is safe.

19.2.2 Maintenance Protocol

- 1 Maintenance protocol for lifts and escalators shall be as per following Indian Standards amended from time to time.:
 - a) IS: 1860 – 1980 Code of Practice for Installation, Operation and Maintenance of Electric Passenger and Goods Lift
 - b) IS: 6620 – 1972 Code of Practice for Installation, Operation and Maintenance of Electric Service Lifts; and
 - c) IS: 4591 – 1968 Code of Practice for Installation and Maintenance of Escalators.
- 2 The lift installation should receive regular cleaning, lubrication adjustment and adequate servicing by authorized person / firm at such intervals as the type of equipment and frequency of service demand.
- 3 In order that the lift installation is maintained at all times in a safe condition, a proper maintenance schedule shall be drawn up in consultation with the lift manufacturer and maintenance firm / person and strictly adhered to.
- 4 A logbook to record all items relating to general servicing and inspection shall be maintained.
- 5 The electrical circuit diagram of the lift with the sequence of operation of different components and parts shall be kept readily available for reference by persons / firm responsible for the maintenance and replacement, where necessary, to the satisfaction of the Competent Authority.
- 6 Any accident arising out of operation of maintenance of the lifts shall be duly reported to the Competent Authority.

19.3 Maintenance of Fire Prevention and Safety Provisions

It shall be the responsibility of the owner of a building to ensure that all the fire prevention and safety provisions in a building are kept in good working condition at all times.

The fire prevention and safety provisions shall include all the fixed fire protection systems, installations, fire extinguishers, first aid kits, fire lifts and escape stairs provided in the building.

19.3.1 Periodic Inspection and Maintenance Certificate

For all buildings with height more than 15 m without stilt and 17.50 m with stilt, the Qualified Agency on Record for Fire shall inspect the building at intervals not more than 24 months to ascertain and certify to the Competent Authority that the building's fire safety has not been compromised due to lack of adequate maintenance.

20 Conformity to other Acts and Rules

20.1 Minimum Clearance from Trunk Infrastructure

In addition to the margins / setbacks from the building unit boundary as per these Rules, the following clearances are to be observed, as applicable.

20.1.1 Minimum Clearance from Electric Lines

For building units in the vicinity of electrical lines, clearances shall be provided between any building or part thereof and electrical lines, according to the following Table No.: 20.1 and Figure No. 20.1:

Table No. 20.1: Minimum clearances from Electric Lines

No.	KV of Electrical Line (x)	Minimum Clearance from Centre of Electrical Grid Line (d) in m
(1)	(2)	(3)
1	220	17.5 m
2	132	13.5 m
3	110	11 m
4	66	9 m
5	33	7.5 m
6	22	3 m
7	11	2.5 m

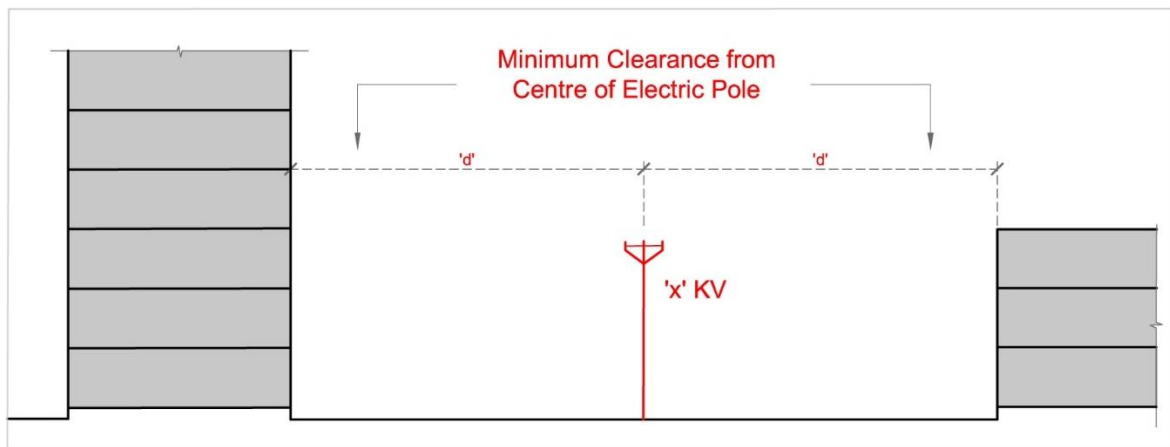

Figure No. 20.1: Minimum clearances from Electric Lines

20.1.2 Minimum Clearance from Petroleum Pipelines

Minimum clearances to be provided between any building or part thereof and petroleum pipelines shall be 12 m from the centre of pipeline.

20.1.3 Minimum Clearance from Oil Well

Clearances to be provided between any building or part thereof and oil well shall be in accordance with provisions of the Oil Mines Regulations, 1984, under the Mines Act, 1952.

20.1.4 Minimum Clearance from Water Body

Minimum clearance shall be provided as per Rule No.17.1

20.2 No Objection Certificates (NOC) / Approvals

Development permission granted to any applicant shall not preclude the necessity of obtaining any other NOC under any other law for the time being in force. The development shall be considered legal and authorised only when all such NOCs are available. Even if the Development Permission or Occupancy Certificate is granted for any building, the Competent Authority may—in its discretion—, proceed against the development as being non authorised if any of the NOCs is not obtained. While the list given below is by no means exhaustive, some of the most common NOCs required are mentioned as under.

20.2.1 NOC from Coast Guard Authority

For building units within Airport Funnel Area and Critical Area, construction for building shall be regulated as per NOC provided by the Coast Guard Authority.

20.2.2 NOC from Railways

For building unit within 30 m vicinity of railway boundary, construction of building shall be regulated as per NOC provided by the Railway Authorities.

20.2.3 NOC from Commissioner of Police / Collector

For building unit with uses for Assembly 1, 2, 3 &4, Religious, Hospitality 1, 2 & 3, and Fuelling Stations, construction of building shall be regulated as per NOC provided by Commissioner of Police / Collector if applicable.

20.2.4 NOC from Jail Authority

For building unit within 300 m vicinity of any jail, construction of building shall be regulated as per NOC provided by the Jail Authority.

20.2.5 NOC from ASI

Development in the vicinity of protected monuments under Ancient Monuments and Archaeological Sites and Remains Act (or AMASR Act), 1958 shall be regulated as per NOC provided by Archaeological Survey of India.

20.2.6 NOC from UT Administration

Development in the vicinity of protected monuments declared under The Goa, Daman and Diu Ancient Monuments and Archaeological Sites and Remains Act, 1978 shall be regulated as per NOC provided by UT Administration

20.2.7 NOC from Defence Establishment

Development in the vicinity of defence establishments, shall be subject to NOC from Station Commander. Explosives Rules 1983 under Indian Explosives Act 1884.

20.2.8 Environmental Clearance

Notification of Requirement of Environmental Clearance of Projects, 1994 (MOEF), Environment Protection Act 1986 and Environment Protection Rules 1986.

20.2.9 NOC under CZMA

For building units within CRZ, construction for building shall be regulated as per approval provided by Coastal Zone Management Authority.

20.3 Conformity to Other Acts

The development must be in conformity to other acts, as applicable:

20.3.1 Factories Act 1948 and Factories Rules.

20.3.2 Gas Cylinders Rules, 1981.

20.3.3 Explosives Rules 1983 under Indian Explosives Act, 1884.

20.3.4 Manufacture, Storage, and Import of Hazardous Chemicals Rule, 1989

21 Quality Control and Inspection

21.1 Applicability

The quality control and inspection shall apply to all residential buildings, which are more than 15 m without stilt and 17.50 m with stilt in height and all non-residential buildings.

21.2 Inspection and Safety Certificate

The owner / developer / occupants and registered appointed Persons on Record shall have to certify the inspection and safety report as per Schedule No.17.

Schedules & Forms

Schedules:

No.	Schedules
1	Minimum Qualification, Experience and Document Requirements for being considered for Registering with the Competent Authority as Persons on Record
2	Procedures for Ascertaining Whether a Person on Record has failed in Discharging his Responsibilities and Penalties
3	Technical Audit Report
4	Buildings requiring Qualified Agency on Record for Fire and Inspection by Fire Officer
5A	Fees and Charges for Grant of a Development Permission / Revised Development Permission / Revalidation of Development Permission
5B	Fees and Charges for Grant of Occupancy Certificate / Change of Occupancy Certificate
5C	Fees for Temporary Construction
5D	Penalties
6A	Drawings, Specifications and Documents to be Submitted with Application for Obtaining / Revising Development Permission for Building and for Sub- division & Amalgamation of Building Unit / Plot
6B	Drawings, Specifications and Documents to be Submitted with Application for Obtaining / Revising / Revalidating Development Permission for Brick Kiln, Mining and Quarrying
6C	Format for submission of Documents, Drawings and Specifications
6D	Drawing, Specification and Documents to be Submitted with Application for Obtaining Permission for Temporary Construction
7A	Information to be Displayed on Site
7B	Documents and Drawings to be Maintained on Site During Period of Construction
7C	Stages of Construction Work for which Notice for Progress of Construction to be Submitted to the Competent Authority
8	Inspection Requirements
9	Documents and Drawings to be Submitted along with the Application for Occupancy Certificate
10	Schedule for Maintenance and Inspection for Structural Stability and Fire Safety
11	Documents and Fees Required with Application for Advertising Display & Communication Infrastructures
12	List of Recommended Trees
13	Standalone Multi-Level Public Parking

Forms:

No.	Forms
1	Application for Registering as Person on Record
2	Certificate of Undertaking for Persons on Record
3	Notice to the Competent Authority of Non-Compliance of Building to Sanctioned Design and Specifications
4	Notice to the Competent Authority of Discontinuation as Person on Record
5	Notice of Cancellation of Development Permission
6	Notice to Stop Unauthorized Development
7	Direct Development Permission
8	Application for Registering Issue of Direct Development Permission
9	Registration or Cancellation of Direct Development Permission / Revised Direct Development Permission / Revalidated Direct Development Permission
10A	Application for Development Permission for Building / Layout / Subdivision / Amalgamation
10B	Application for Development Permission for Brick Kiln, Mining and Quarrying
10C	Application for Development Permission for Temporary Construction
11A	Area Statement for Buildings
11B	Area Statement for Subdivision / Amalgamation / Layout of Land
11C	Area Statement for Temporary Construction
12	Grant/Refusal of Development Permission / Revised Development Permission / Revalidated Development Permission
13	Application for Revised Direct Development Permission
14	Application for Registering Issue of Revised Direct Development Permission
15	Application for Revising Development Permission for Building / layout / Sub – division / Amalgamation
16	Application for Revalidating Direct Development Permission / Revised Direct Development Permission
17	Application for Registering a Revalidated Direct Development Permission / Revised Direct Development Permission
18	Application for Revalidating a Lapsed/ Suspended Development Permission / Revised Development Permission
19	Notice for Commencement of Construction
20	Notice for Progress of Construction
21	Notice for Completion and Compliance Certification
22A	Application for Occupancy Certificate
22B	Application for Occupancy of Temporary Construction
23	Grant / Refusal of Occupancy Certificate
24	Cancellation of Occupancy Certificate
25	Change in the Sanctioned Occupancy of Building / Development
26	Structural Inspection Report
27	Fire Safety Certificate

Tables

Table No. S1-1	SEOR Qualification and Experience
Table No. S1-2	COWOR Qualification and Experience
Table No. S1-3	SOR Qualification and Experience
Table No. S2-1	Penalties for Person on Record
Table No. S3-1	Details of Technical Audit Report
Table No. S4-1	Qualified Agency on Record for Fire Requirement as per Building Use/Occupancy
Table No. S5A-1	Scrutiny Fees for Buildings
Table No. S5A-2	Fees for Subdivision/ Amalgamation/ Layout of Building Unit / Plot
Table No. S5A-3	Charges for Change of Land Use
Table No. S5A-4	Development Charges for Buildings
Table No. S5A-5	Charges for Stacking Building Material on Public Roads
Table No. S5B-1	Fees for Occupancy Certificate
Table No. S5B-2	Fees for Change of Occupancy
Table No. S5C-1	Fees for Applying for Temporary Construction
Table No. S5D-1	Penalties for Unauthorized Construction and Occupancy
Table No. S5D-2	Penalties Applicable for Regularizing Unauthorised Construction for Residential Use
Table No. S6C-1	Drawing Sizes
Table No. S6C-2	Colours and Notations for Drawings and Documents
Table No. S8A-1	Principles of Risk Categorization (Definition of Consequence Class) and Inspection Requirements
Table No. F10A-1	Information Sheet with Application for Development Permission for Building/ Layout / Amalgamation/ Subdivision
Table No. F10B-1	Application for Development Permission for Brick Kiln, Mining and Quarrying
Table No. F10C-1	Information Sheet with Application for Development Permission for Temporary Construction
Table No. F11A-1	Area Statement for Buildings
Table No. F11B-1	Area Statement for Subdivision / Amalgamation / Layout of Land
Table No. F11C-1	Area Statement for Temporary Construction
Table No. F26-1	Details of Structural Inspection Report (Part 1)
Table No. F26-2	Details of Structural Inspection Report (Part 2)
Table No. F26-3	Details of Structural Inspection Report (Part 3)

Schedule

Schedule No. 1

Minimum Qualification, Experience and Document Requirements for being considered for Registering with the Competent Authority as Persons on Record

(Refer Rule No. 3.2.1, 3.2.2, 3.2.3)

The procedure for registering persons with the Competent Authority is given in Rule No. 3.2.1. The registration shall be renewed annually. The following are the minimum qualifications and experience requirements for all persons to be considered for registering with the Competent Authority as Persons on Record, in order to determine their competence to fulfil their responsibilities as specified in Rule No. 3.2.2.

1 Architect on Record (AOR)

A Qualification and Experience:

Minimum qualifications and experience requirements for architects, for being considered for registration with the Competent Authority, as Architects on Record shall be as follows:

- (a) Architect must hold a valid registration with the Council of Architecture, India, issued as per the provisions of the Architects Act, 1972 or Bachelor's Degree in Architecture / Diploma in Architecture Equivalent to B. Arch; and
- (b) Architect must have a minimum of two years of experience in practice of architecture.

B Scope Work and Competence:

- (a) Preparation & planning of all types of layouts; submission of drawings; submission of certificate of supervision, progress reports and submission of certificate of completion for all types of buildings in accordance with the provisions of these building Rules.
- (b) Supervision & execution of construction work as per specifications & drawings prepared by authorised registered structural designer & engineer.

2 Civil Engineer on Record (EOR)

A Qualification and Experience:

Minimum qualifications and experience requirements for engineers, for being considered for registration with the Competent Authority, as Engineers on Record shall be as follows:

- (a) Master's Degree in Civil Engineering, a bachelor's degree in Civil Engineering or Building construction or its equivalent qualification recognized by the All-India Board of Technical Education, or, a Diploma in Civil Engineering or Diploma in Building Construction recognized by State Board of Technical Examination of any State of India or Associate Membership (Civil Engineering) of the Institute of Engineers, India (AMIE), and
- (b) Engineer having bachelor's degree, or its equivalent qualification must have minimum of two years of experience and Diploma holder/or AMIE must have minimum of five years of experience in professional work.

B Scope Work and Competence:

- (a) Preparation & planning of all types of layouts except special structures / special buildings as per these Rules; submission of drawings and submission of certificate of supervision & completion for all types of buildings. A person having qualification of a Diploma in Civil Engineering shall be permitted to undertake low rise buildings only.

- (b) Supervision & execution of construction work as per specifications & drawings prepared by authorized registered structural designer.
- (c) He / she can prepare & submit structural details & calculations for buildings of load bearing structures.

3 Structural Engineer on Record (SEOR)

A Qualification and Experience:

Minimum qualifications and experience requirements for structural engineers, for being considered for registration with the Competent Authority as Structural Engineer on Record shall be as follows:

Table No. S1 – 1: SEOR Qualifications and Experience

Grade	Scope of Work	Qualification	Minimum Years of Experience*
SEOR 1	1 Building with height above 25 m	Category 1	10
	2 Total proposed built-up area for a building unit is more than 10000 sqm 3 Mercantile - 2, 3; Educational -1, 2, 3; Assembly - 1, 2, 3; Health – 2, 3, 4; Hospitality – 2, 3, Utility; Public Office; Special Buildings	Category 2	3
SEOR 2	1 Building with height above 15 m /17.5 m (with Stilt) and up to 25 m	Category 1	5
	2 Total proposed built-up area for a building unit is more than 2000 sqm and up to 10000 sqm	Category 2	2
SEOR 3	1 Building with height up to 15 m /17.5 m (with Stilt).	Category 1	2
	2 Total proposed built-up area for building unit up to 2000 sqm	Category 2	-----
Notes:			
1 *Minimum years of experience of preparing structural design, detailed drawings, and specifications after attaining the degree/ Diploma.			
2 Category 1: B.E/ B. Tech Civil or equivalent degree recognized by the AICTE.			
3 Category 2: M.E/ M. Tech Civil, or a Ph. D in Structural Engineering.			
4 Person holding Higher grade license can also work for Lower Grade Work			

4 Clerk of Works on Record (COWOR)

A Qualification and Experience:

Minimum qualifications and experience requirements for construction engineers, for being considered for registration with the Competent Authority as Clerk of Works on Record qualified for certifying the construction of buildings shall be as follows:

Table No. S1 – 2: COWOR Qualifications and Experience

Grade	Scope of Work	Qualification	Minimum Years of Experience*
COWOR 1	1 Building with height above 25 m	Category 1	3
	2 Total proposed built-up area for a building unit is	Category 2	5

Grade	Scope of Work	Qualification	Minimum Years of Experience*
	more than 10000 sqm. 3 Mercantile - 2, 3; Educational -1, 2, 3; Assembly - 1, 2, 3; Health - 2, 3, 4; Hospitality - 2, 3; Utility; Public Office; Special Buildings	Category 3	3
COWOR 2	1 Building with height above 15 m /17.5 m (with Stilt) and up to 25 m.	Category 1	2
		Category 2	4
	2 Total proposed built-up area for a building unit is more than 2000 sqm and up to 10000 sqm.	Category 3	2
COWOR 3	1 Building with height up to 15 m /17.5 m (with Stilt).	Category 1	1
		Category 2	2
	2 Total proposed built-up area for building-unit up to 2000 sqm	Category 3	1
Notes:			
1 *Minimum years of experience (after attaining the degree/ Diploma) in Construction work at a responsible position in any organization			
2 Category 1: A Degree in Civil Engineering / Architecture or Diploma in Architecture equivalent to degree Architecture, or its equivalent qualification recognized by All India Board of Technical Education			
3 Category 2: Diploma in Civil Engineering recognized by State Board of Technical Examinations of any State in India			
4 Category 3: Bachelor's Degree with specialized training in building in construction technology or Diploma in Building Construction Technology from a recognized institute.			
5 Person holding Higher grade license can also work for Lower Grade Work			

5 Supervisor of Works on Record (SOR)

A Qualification and Experience:

Minimum qualifications and experience requirements for construction engineers, for being considered for registration with the Competent Authority as Supervisor of Works on Record qualified for certifying the construction of buildings shall be as follows:

Table No. S1 – 3: SOR Qualifications and Experience

Grade	Scope of Work	Qualification	Minimum Years of Experience*
SOR 1	1 Building with height above 25 m 2 Total proposed built-up area for a building unit is more than 10000 sqm	Category 1	3
		Category 2	5
	3 Mercantile - 2, 3; Educational -1, 2, 3; Assembly - 1, 2, 3; Health - 2, 3, 4; Hospitality - 2, 3; Utility; Public Office; Special Buildings	Category 3	3
SOR 2	1 Building with height above 15 m /17.5 (with Stilt) m and up to 25 m	Category 1	2
		Category 2	4
	2 Total proposed built-up area for a building unit is more than 2000 sqm and up to 10000 sqm	Category 3	2
SOR 3	1 Building with height up to 15 m /17.5 (with Stilt) m	Category 1	1
	2 Total proposed built-up area for building-unit up to 2000	Category 2	2

Grade	Scope of Work	Qualification	Minimum Years of Experience*
	sqm	Category 3	1
SOR 4	1 Building with height up to 10 m	Category 1	0
	2 Total proposed built-up area for building-unit up to 200 sq m	Category 2	1
<p>Note:</p> <ol style="list-style-type: none"> 1 *Minimum years of experience (after attaining the degree/ Diploma) in Construction work at a responsible position in any organization 2 Category 1: A Degree in Civil Engineering / Architecture or Diploma in Architecture equivalent to degree Architecture, or its equivalent qualification recognized by All India Board of Technical Education 3 Category 2: Diploma in Civil Engineering recognized by State Board of Technical Examinations of any State in India 4 Category 3: Bachelor's Degree with specialized training in building in construction technology or Diploma in Building Construction Technology from a recognized institute. 5 Person holding Higher grade license can also work for Lower Grade Work 			

Schedule No. 2

Procedures for Ascertaining Whether a Person on Record has failed in Discharging his Responsibilities and Penalties

(Refer Rule No. 3.2.5)

- 1 Procedure for Ascertaining whether a Person on Record has failed to Discharge his Responsibility.

A four-member Professional Oversight Committee shall be established by the Union Territory / PDA to ascertain whether a Person on Record has failed to discharge his responsibilities.

The Professional Oversight Committee shall comprise of the following four members:

- 1 The Member Secretary
- 2 MS, PDA (respective)
- 3 Associate Town Planner of the PDA
- 4 Expert Architect / Engineer from the Private Sector

The Professional Oversight Committee shall undertake scrutiny of each case on an individual basis and shall provide at least one opportunity to the Person on Record under scrutiny to be heard. Its proceedings shall be recorded in writing.

The cost(s) incurred for conducting the scrutiny shall be borne by the PDA.

The Professional Oversight Committee shall ascertain whether the Professional on Record has failed in discharging his responsibilities and shall determine and administer penalties for the same.

2. Penalties for Person on Record for Failing to Discharge his Responsibilities

Table No. S2 – 1: Penalties for Person on Record

Violation of Reg. No.:	Financial penalty¹	Financial penalty¹	Financial penalty¹	Financial penalty¹ and delisting for 6 months	Delisting for 12 months and registration of complaint with professional body	Permanent delisting and prosecution¹
Rule Nos. 4.4: Person on Record undertake construction on plot without revalidating a Lapsed Development Permission or when a Development Permission has been cancelled		1 st offence (Rs. 10,000)	2 nd offence (Rs.15,000)	3 rd offence (Rs.20,000)	4 th offence (Rs.25,000)	5 th offence (Rs.30,000)
Rule No. 5.4: Negligence of Person on Record leading to structural failure of a building						1 st offence (Rs.50,000)
Rule Nos. 4.10.1, 4.12.1 and 4.14.1: Architect on Record fails to register the Issue of Direct Development Permission / Revision of Direct Development Permission / Revalidation of Direct Development Permission with the Commissioner within the stipulated period		1 st offence (Rs. 10,000)	2 nd offence (Rs.15,000)	3 rd offence (Rs.20,000)	4 th offence (Rs.25,000)	5 th offence (Rs.30,000)
Rule Nos. 4.10, 4.11, 4.12, 4.13, 4.14, 4.15, 4.16: Person on Record submits incomplete or inadequate drawings, document, and specifications along with application to register Issue of Direct Development Permission / Revision of Direct Development Permission / Revalidation of Direct Development Permission to the Commissioner		1 st offence (Rs. 10,000)	2 nd offence (Rs.15,000)	3 rd offence (Rs.20,000)	4 th offence (Rs.25,000)	5 th offence (Rs.30,000)
Rule Nos. 4.10, 4.11, 4.12, 4.13, 4.14, 4.15, 4.16: Person on Record intentionally and fraudulently misrepresents or hides material facts from the Commissioner in the application to register issue of or grant of Development Permission / Revised Development Permission / Revalidation of Development Permission				1 st offence (Rs. 15,000)	2 nd offence (Rs.25,000)	3 rd offence (Rs.35,000)
Rule No. 5.2: Construction Engineer on Record fail to display necessary information on the Notice Board at site	1 st offence (Rs. 10,000)	2 nd offence (Rs.15,000)	3 rd offence (Rs.20,000)	4 th offence (Rs.25,000)	5 th offence (Rs.30,000)	

¹ Prosecution under section 140 (y) and 141 of the Dadra and Nagar Haveli and Daman and Diu Town & Country Planning Act, 1974

Violation of Reg. No.:	Financial penalty¹	Financial penalty¹	Financial penalty¹	Financial penalty¹ and delisting for 6 months	Delisting for 12 months and registration of complaint with professional body	Permanent delisting and prosecution¹
Rule No. 5.3: Construction Engineer on Record fails to maintain necessary drawings and documents at site during Period of Construction	1 st offence (Rs. 10,000)	2 nd offence (Rs.15,000)	3 rd offence (Rs.20,000)	4 th offence (Rs.25,000)	5 th offence (Rs.30,000)	
Rule No. 5.4.1: Architect on Record and Construction Engineer on Record stack, store or dispose building material on public space or street without obtaining Permit to Use Abutting Street for Construction	1 st offence (Rs. 10,000)	2 nd offence (Rs.15,000)	3 rd offence (Rs.20,000)	4 th offence (Rs.25,000)	5 th offence (Rs.30,000)	
Rule No. 5.4.2: Construction Engineer on Record does not provide barricading or provides inadequate barricading of the plot during period of construction	1 st offence (Rs. 10,000)	2 nd offence (Rs.15,000)	3 rd offence (Rs.20,000)	4 th offence (Rs.25,000)	5 th offence (Rs.30,000)	
Rule No. 5.4.3: Construction Engineer on Record causes or fails to prevent damage or inconvenience during construction	1 st offence (Rs. 10,000)	2 nd offence (Rs.15,000)	3 rd offence (Rs.20,000)	4 th offence (Rs.25,000)	5 th offence (Rs.30,000)	
Rule Nos. 5.5.1: Architect on Record or Construction Engineer on Record fail to notify the Commissioner before commencing construction on the plot within the stipulated period		1 st offence (Rs. 15,000)	2 nd offence (Rs.20,000)	3 rd offence (Rs.25,000)	4 th offence (Rs.30,000)	5 th offence (Rs.40,000)
Rule Nos. 5.5.3: Architect on Record and Construction Engineer on Record fail to notify the PDA of Progress of Construction, Compliance Certification and obtaining Permission to Proceed with Further Construction within the stipulated period		1 st offence (Rs. 15,000)	2 nd offence (Rs.20,000)	3 rd offence (Rs.25,000)	4 th offence (Rs.30,000)	5 th offence (Rs.40,000)
Rule No. 6.5.1 and 6.6.1: Person on Record submits incomplete or inadequate drawings, document, and specifications to the PDA along with application to register Issue or grant of Development Use Permission or Permission to Change Sanctioned Use of Development		1 st offence (Rs. 10,000)	2 nd offence (Rs.15,000)	3 rd offence (Rs.20,000)	4 th offence (Rs.25,000)	5 th offence (Rs.30,000)
Rule Nos. 6.5 and 6.6: Person on Record intentionally and fraudulently misrepresents or hides material facts from the PDA in the application to register issue or grant of				1 st offence (Rs. 15,000)	2 nd offence (Rs.25,000)	3 rd offence (Rs.35,000)

Violation of Reg. No.:	Financial penalty¹	Financial penalty¹	Financial penalty¹	Financial penalty¹ and delisting for 6 months	Delisting for 12 months and registration of complaint with professional body	Permanent delisting and prosecution¹
Development Use Permission or Permission to Change Sanctioned Use of Development						
Rule Nos. 3.3.2: If there is any deviation from building sanction plan the AOR blacklisted for 10 years						1 st offence (Rs.50,000)
Rule Nos. 5.1.4: Qualified Agency on Record for Fire shall inspect the building at interval of every six months to ascertain and certify to competent authority that the building's fire safety has not been compromised due to lack of adequate maintenance. For not doing so penalties will be taken						1 st offence (Rs.1,00,000)

NOTES:

- 1 All financial penalties are to be decided by the Professional Oversight Committee of the PDA to ascertain whether a Person on Record has failed to discharge his responsibilities and to determine penalties for the same.
- 2 If the penalties imposed in the 1st offence are not complied with by the Person on Record within 1 month of the date of imposing the penalty, the penalty for 2nd offence shall apply and so forth.
- 3 If the penalties imposed in the 1st offence are not complied with by the Person on Record within 6 months of the date of imposing the penalty, the Person on Record shall be unregistered from the records of the PDA for 1 year and complaint filed with his professional body.

Schedule No. 3

Technical Audit Report

(Refer Rule No. 3.3)

Table No. S3 – 1: Details of Technical Audit Report

1	Design	Comments	
	1.1	Design / Drawings available?	Y/N
	1.2	Design Category	
	1.2.1	Type Design?	Y/N
	1.2.2	Specific Design	Design to be collected to refer to Design Consultant /H.O.
	1.3	Drawings prepared / checked by competent Authority?	Y/ N
	1.3	Design Drawing/ Details	Y/ N
	1.5	Structural details included	Y/ N
	1.6	Earthquake/cyclone resistant features Included?	Y/ N
	1.7	Design verified/vetted by Dept./Govt. approved agency/competent authority?	Y/N
	1.8	Design changes approved by Dept./Govt. approved agency/competent authority	Y/N
2	Foundation		
	2.0	Foundation used	Existing/ New
	2.1	If existing foundation used	
	2.1.1	Depth of foundation below ground	<50 cm @ 50-70/> 70cm
	2.1.2	Type of masonry	Stone / Bricks / PCC Blocks
	2.1.3	Thickness of masonry (above ground)	23cin /35 />35
	2.1.4	Mortar used	Cement – Sand
	2.1.5	Mix of cement mortar	As per NBC Indicate
	2.1.6	Height up to Plinth	_____m, as per GDCR Y/N
	2.1.7	If stone masonry	
	2.1.7.1	Through Stones	Yes / No. If Yes Adequate/Inadequate
	2.1.7.2	Corner Stones	Yes / No. If Yes Adequate/Inadequate
	2.2	If a new foundation used	
	2.2.1	Depth of foundation below ground	<50/50-70/>70 cm
	2.2.2	Type of masonry blocks	Stone / bricks / PCC
	2.2.3	Thickness of Masonry above plinth -	23cm/35/>35cm
	2.2.4	Mortar used	Cement-sand / lime / mud
	2.2.5	Mix of cement mortar (1:4)/As Per NBC	Yes/No
	2.2.6	Height up to plinth	_____m, as per GDCR Y/N
	2.2.7	If stone masonry	
	2.2.7.1	Through Stones	Yes / No. If Yes Adequate/Inadequate
	2.2.7.2	Comer Stones	Yes / No. If Yes Adequate/Inadequate
	2.3	Vertical reinforcement in foundation	Yes / No
3	Walls		
	3.1	Type of masonry	Stone/ Brick / PCC Blocks
	3.2	Mortar used	Cement- Sand / Lime /Mud
	3.3	Mix of cement mortar	1:4 /1:1.6/Leaner
	3.4	Thickness of wall	>23cm/23cm/23cm
	3.5	Mixing of mortar	OK /Not OK
	3.6	Join property filled	OK /Not OK

	3.7	Wetting of bricks	Good / Medium / Poor
	3.8	Stone masonry	
	3.8.1	Through Stones	Yes/No
	3.8.2	Corner Stones	Yes / No
	3.9	Overall workmanship	Good / Medium / Poor
4	Roofing		
	4.1	Type of roof	Flat / Sloping
	4.2	If sloped	Morbid tiles / AC sheet / G.I. sheet
	4.3	Purlins	Angle - Material - Iron/ Timber/ NA
	4.4	Truss type	
	4.5	Anchorage with wall	Adequate / Inadequate /NA
5	Materials		Specifications must be conforming to NBC/Relevant IS Codes
	5.1	Cement	
	5.1.1	Source	Authorized Dealer / Market OPC/PPC/ PSC
	5.1.2	Type of cement	Grade (33 / 43 / 53)
	5.1.3	If OPC	OPC / PPC/ PSC
	5.2	Sand	
	5.2.1	Type of sand	Fine / Coarse
	5.2.2	Presence of deleterious materials	Mild / Moderate / High
	5.3	Coarse Aggregates	
	5.3.1	Type coarse Aggregates	Gravel / Crushed Stone
	5.3.2	Presence of deleterious material	Mild / Moderate / High
	5.4	P.C.C. Blocks (Applicable for onsite production)	
	5.4.1	Type of P.C.C. Blocks	Solid blocks / Hollow blocks
	5.4.2	Ratio of concrete in block	
	5.4.3	Interlocking feature	Yes / No
	5.4.4	Coarse aggregates used	Natural / Crushed stone
	5.5	Bricks Blocks, Stone etc.	
	5.5.1	Strength (field assessment)	Low / Medium / High
	5.5.2	Dimensional accuracy	Yes / No
	5.6	Concrete	
	5.6.1	Mix of concrete	(1:1 1/2:3)/ (1:2:4)/ Design Mix
	5.6.2	Batching	Weight batching/ Volume batching
	5.6.3	Compaction	Vibrators / Thappies and rods
	5.6.4	Workability	Low / Medium / High
	5.6.5	Availability of water	Sufficient / Insufficient
	5.6.6	Curing	Satisfactory/ unsatisfactory
	5.7	Reinforcing Steel	
	5.7.1	Type of Steel	Plain mild steel HYSD bars
	5.7.2	Source	Authorized Dealer /Market
	5.7.3	Whether IS Marked	Yes/No
	5.7.4	Conditions of bars	Clean / Corrugated
	5.7.5	Fixing of reinforcement as per drawing	Yes / No
	5.7.6	Suitable cover	Yes/No
	5.7.7	Spacing of bars	Regular / Irregular
	5.7.8	Overlaps as per specifications	Yes / No
	5.8	Form Work	Timber/ Ply board /Steet
	5.8.1	Type of form work	Yes/No
	5.8.2	Use of mould oil	
	5.8.3	Leakage of cement slurry	Observed / Not
	5.9	Source	
	5.9.1	Cement	
	5.9.2	Sand	
	5.9.3	Coarse Agg.	

	5.9.4	Bricks	
	5.9.5	PCC Blocks	
6	Seismic Resistance Features for Masonry Structures		
	6.1	Provision of seismic band provided Adequate	Yes/No
	6.1.1	Plinth level	Yes/No
	6.1.2	Stilt level	Yes/No
	6.1.3	Lintel level	Yes/No
	6.1.4	Roof level (if applicable)	Yes/No
	6.2	If sloped roof, whether seismic bands are provided at	Yes/No
	6.2.1	Gable wall top	Yes/No
	6.2.2	Eaves level	Yes/No
	6.3	Provision of vertical street in masonry at	Yes/No
	6.3.1	Each corner	Yes/No
	6.3.2	Each T- junction	Yes/No
	6.3.3	Each door joint	Yes/No
	6.3.4	Around each window	Yes/No
	6.4	Openings	Yes/No
	6.4.1	Total width of openings (*-42% for double storey)	<50%/50*-60%/>60%
	6.4.2	Clearance from corner	Ok/ Not Ok
	6.4.3	Pier width between two opening	Ok/ Not Ok

Name of AOR
 Registration No.:
 Address:
 Tel. No.:
 Signature:
 Date:

Name of EOR:
 Registration No.:
 Address:
 Tel No.:
 Signature:
 Date:

Name of SEOR
 Registration No.:
 Address:
 Tel. No.:
 Signature:
 Date:

Name of COWOR:
 Registration No.:
 Address:
 Tel No.:
 Signature:
 Date:

Name of SOR:
 Registration No.:
 Address:
 Tel. No.:
 Signature:
 Date:

Schedule No. 4**Buildings requiring Qualified Agency on Record for Fire and Inspection by Fire Officer**

(Refer Rule No. 3.3.7, 5.1.4)

Table No. S4 – 1: Qualified Agency on Record for Fire Requirement as per Building Use / Occupancy

Building Use	Criteria	Qualified Agency on Record for Fire	The Fire Officer
Dwelling 1, 2, 3, Dharamshala	Building Height >15 m	Required	Required
Mixed Use or Mercantile 1, 2, 3	Building Height >15 m or G+4	Required	Required
Hospitality 1, 2, 3 Education 1, 2, 3 Public Offices Utilities Dharamshala/Hostel Health 1,2,3,4 Mercantile 1,2 Assembly 1,2, 3, 4	Irrespective of area and height	Required	Required
Mercantile 3, Storage	Built up area >250 sq m.	Required	Required
Light Industrial, General Industrial White Industries	Built up area >250 sq m	Required	Required
Orange Industries Hazardous, Special Industries	Built up area >100 sq m	Required	Required
Temporary use, Fair, Circus, exhibition, Mela, Pandal, Amusement Park	Built up area > 50 sq m or seating capacity > 50 persons		
Religious Building	Built up area >250 sq m	Required	Required
Fuelling Station	Irrespective of area and height	Required	Required

Note: In case of applicability criteria which are minimum shall be applicable.

Schedule No. 5A

Fees and Charges for Grant of a Development Permission / Revised Development Permission / Revalidation of Development Permission

(Refer Rule No. 4.10.2, 4.11.2, 4.12.2, 4.13.2, 4.14.2, 4.15.2, 5.3, 5.4.1, 6.6.2)

A person applying for a Development Permission / Revised Development Permission / Revalidation of Permission shall have to pay the following Fees and Charges along with the application to the Competent Authority at the following rates:

A Fees:

1 Scrutiny Fees for Buildings:

The fees shall be paid for both – Direct Development Permission and Development Permission. The scrutiny fees shall be levied at the time of making an application for Development Permission.

Table No. S5A – 1: Scrutiny Fees for Building

No	Type of Use	Rate per sq m of Built-Up Area (Subject to minimum fees of Rs. 1000/-)	
		Building upto 15m height	Building more than 15m height
1	Residential	Rs. 5.00	Rs. 10.00
2	Commercial	Rs. 8.00	Rs. 13.00
3	Residential Cum Commercial	Rs. 6.00	Rs. 11.00
4	Industrial	Rs. 7.00	Rs. 12.00
5	Public Offices, Utilities	Rs. 4.00	Rs. 9.00
6	Others	Rs. 5.00	Rs. 10.00

(*others: includes Health, Education, etc. and other than the above-mentioned type of land use)

- In case of a revised development permission, these shall be paid again.
- In case of revalidation of lapsed / suspended development permission, these shall not be paid again, only a revalidation fee will be paid which will be 25% of the Scrutiny Fee already paid.
- In case of cancellation of development permission, these shall be forfeited.

2 Fees for Subdivision / Amalgamation / Layout of Land

A One-time payment shall be made for approval of subdivision / amalgamation / layout of land. It shall be valid for a period of 5 years.

Table No. S5A – 2: Fees for Subdivision / Amalgamation / Layout of Building Unit / Plot

No	Type of land Use	Rate per sq m of land (Subject to minimum fees of Rs. 1000/-)	
		Amalgamation	Subdivision / Layout of Building Unit / Plot
1	Residential	Rs. 3.00	Rs. 6.00
2	Commercial	Rs. 4.00	Rs. 8.00
3	Residential Cum Commercial	Rs. 3.50	Rs. 7.00
4	Industrial	Rs. 5.00	Rs. 10.00
5	Public Offices, Utilities	Rs. 3.00	Rs. 6.00
6	Others	Rs. 4.00	Rs. 8.00

(*others: includes Health, Education, etc. and other than the above-mentioned type of land use)

- In case of a revised development permission, these shall be paid again.
- In case of revalidation of lapsed / suspended development permission, these shall not be paid again, only a revalidation fee will be paid which will be 25% of the Scrutiny Fee already paid.
- In case of cancellation of development permission, it shall be forfeited.

3 Fees for Mining, Quarrying and Brick Kiln Operations

Mining, quarrying and brick kiln with or without chimney and processing of lime, sagol etc. without construction- Rs.1,00,000 per 0.1 hectare or part thereof.

- In case of a revised development permission, these shall be paid again.
- In case of revalidation of lapsed / suspended development permission, these shall not be paid again, only a revalidation fee will be paid which will be 25% of the Scrutiny Fee already paid.
- In case of cancellation of development permission, it shall be forfeited.

B Charges

1 Charges for Change in Land Use:

Charges for change in land use shall be paid every time there is a change of use of land.

Table No. S5A – 3: Charges for Change of Land Use

No	Type of land Use	Rate per sq m of land (Subject to minimum fees of Rs. 1000/-)
1	Residential	Rs. 25.00
2	Commercial	Rs. 40.00
3	Residential Cum Commercial	Rs. 40.00
4	Industrial	Rs. 50.00
5	Public Offices, Utilities	Rs. 10.00
6	Others	Rs. 40.00

(*others: includes Health, Education, etc. and other than the above-mentioned type of land use)

2 Development Charges for Infrastructure:

- The Development Charges for infrastructure shall be paid for both – Direct Development Permission and Development Permission.
- The development charges for infrastructure shall be levied at the time of making an application for Development Permission.

Table No. S5A – 4: Development Charges for Buildings

No	Type of land Use	Rate per sq m of Built up (Subject to minimum fees of Rs. 1000/-)
1	Residential	Rs. 50.00
2	Commercial	Rs. 80.00
3	Residential Cum Commercial	Rs. 80.00
4	Industrial	Rs. 100.00
5	Public Offices, Utilities	Rs. 20.00
6	Others	Rs. 80.00

(*others: includes Health, Education, etc. and other than the above-mentioned type of land use)

- In case of a revision of development permission, the differential shall be paid.
- In case of revalidation of lapsed / suspended development permission, these shall not be paid again.
- In case of cancellation of development permission, it shall be forfeited.

3 Stacking Charges

Stacking Charges shall be levied during grant of commencement certificate and charges will be taken per week.

Table No. S5A – 5: Charges for Stacking Building Material on Public Roads

No	Type of land Use	Rate per sq m of Building Unit (Subject to minimum fees of Rs. 1000/-)
1	Residential	Rs. 4.00
2	Commercial	Rs. 8.00
3	Residential Cum Commercial	Rs. 6.00
4	Industrial	Rs. 10.00
5	Public Offices, Utilities	Exempted
6	Others	Rs. 4.00

(*others: includes Health, Education, etc. and other than the above-mentioned type of land use)

4 Tree Plantation

A person applying for permission to carry out any development shall have to pay tree plantation deposit (Rs. 2000 / tree required to be planted) along with his application to the Competent Authority. This deposit shall be refundable after the period of five years with the condition that trees planted on the site shall be grown up and maintained properly, otherwise the deposit shall be forfeited and shall be utilised only for tree plantation and maintenance by the Competent Authority.

C Other Charges/Fees

Other Charges / Fees shall be levied under the provisions of other Act and or instructed by Government.

Note: All Charges and Fees may be revised by MS PDA from time to time.

Schedule No. 5B

Fees and Charges for Grant of Occupancy Certificate / Change of Occupancy Certificate

(Refer Rule No. 6.5.2)

A Occupancy Certificate

A person applying for an Occupancy Certificate shall have to pay Fees along with the application to the Competent Authority at the following rates:

Table No. S5B – 1: Fees for Occupancy Certificate

No. (1)	Description (2)	Fees equal to (3)
1	If the Occupancy is in conformity with these Rules and no change from the permission granted.	10% of the Development Permission Scrutiny Fees that is leviable on the building unit, as the case may be

B Change of Occupancy

If the development use is in conformity with the General Development Rules but there is change of use, then a fee equal to two times of the Scrutiny Fees paid shall be paid.

The Development Charges as per the new proposed use shall be paid – the earlier shall be forfeited.

Table No. S5B – 2: Fees for Change of Occupancy

No. (1)	Description (2)	Fees equal to (3)
1	In conformity with these Rules but with internal modification without any change in overall location and/or overall dimension or margins of the building.	Two times of the Development Permission Scrutiny Fees that is leviable on the building unit, as the case may be.

Schedule No. 5C
Fees for Temporary Construction

(Refer Rule No. 4.16.2)

A FEES FOR TEMPORARY CONSTRUCTION PERMISSION

Table No. S5C – 1: Fees for Applying for Temporary Construction

No.	Type of Temporary Construction	Rate per sq m of land (Subject to minimum fees of Rs. 1000/-)
1	Pandals for fair, ceremonies, religious functions	Rs 100

- Equal amounts of fees shall be payable as deposit, which will be refundable provided by end of the stipulated period, such temporary structures are removed without fail by the owner / applicant.
- Failure to remove such temporary sheds will be liable for forfeiture of the deposit and any such failure continuing beyond the said period shall be liable for imposition of penalty which will, be three times the rate of 100/ per sq m per week.

Schedule No. 5D

Penalties

(Refer Rule No. 4.4.4, 4.6, 4.7.2, 4.10.4, 4.11.4, 4.12.4, 4.13.4, 4.14.4, 4.15.4, 4.16.4, 6.5.4, 6.6.4)

A PENALTIES FOR UNAUTHORIZED CONSTRUCTION AND OCCUPANCY

Table No. S5D – 1: Penalties for Unauthorised Construction and Occupancy

No.	Type	Penalty (Rs/ Sq m)	Remarks
1	Construction started / completed before applying for permission.		Applicable to the total built area within the plot
	1.1 For Residential	300	
	1.2 For Commercial	500	
	1.3 For Industrial	800	
	1.4 For Others use	600	
2	Construction started / completed before granting permission but had applied for permission.		Applicable to the total built area within the plot
	1.1 For Residential	200	
	1.2 For Commercial	300	
	1.3 For Industrial	500	
	1.4 For Others use	400	
3	Minor Deviation from the approved construction plan, but within these Rules.	Twice the scrutiny fees	Deviation in this respect would be only for minor alteration within the approved building plan without deviation in approved built up area

B OTHER PENALITES

- Penalties for Lift

Lift auditor shall provide certificate at interval not more than 2 years that the lifts and escalator in the building are kept in good working condition. For not doing so penalties will be levied as decided by Competent Authority.

- Parking Space Misuse

In cases where misuse of parking space is noticed, the use of the entire building shall be discontinued by the Competent Authority. Building use shall be permitted only after the required parking spaces are provided. High penalty shall be levied considering the period of misuse of the parking space and the benefit derived out of misuse as decided by the Competent Authority from time to time.

Schedule No. 6A

Drawings, Specifications and Documents to be Submitted with Application for Obtaining/ Revising Development Permission for Building and for Sub- division & Amalgamation of Building Unit / Plot

(Refer Regulation No. 4.10.1, 4.11.1, 4.12.1, 4.13.1, 4.14.1, 4.15.1)

The owner / developer shall submit to the Competent Authority the following documents, drawings, and specifications along with application for obtaining and revising a development permission. These are common documents for obtaining / revising development permission for buildings and for sub-division & amalgamation of building unit / plot.

A Copies of Documents, Drawings and Specifications

- 1 Five copies of all plans and statements shall be made available along with the notice. Soft copy of the drawings in cad format shall also be submitted.
- 2 All documents, drawings, and specifications to be submitted along with the notice shall be duly signed by the Owner and the appropriate Person on Record and shall indicate their names, contact information and registration number.
- 3 Every drawing, document and report shall be signed by the Owner and the Architect on Record or Civil Engineer on Record, the Structural Engineer on Record, and the Clerk of Works on Record as the case may be and in accordance with the General Development Rules.

B List of Documents which needs to be uploaded or submitted offline

- 1 Satisfactory documentary legal evidence of the Right to Develop or Build on the Building Unit, including original copies of the relevant extract from the Property Register for City Survey Lands or Record of Rights for Revenue Lands as applicable.
- 2 Certified copies of approved sub-divisions or layout of the final plot from the concerned Authority as the case may be showing:
 - a City Survey No. or Revenue No.
 - b Area and measurements of the building unit. Authority may dispense with this requirement in the cases where it is satisfied regarding the ownership of land on the basis of any documentary evidence or proof produced by the applicant.
- 3 Copy of Sanctioned Layout including date of sanction and Reference No.
- 4 Certified part plan and zoning certificate from the Authority.
- 5 Form No 10A/13: Application for obtaining / revising a development permission.
- 6 Form No. 2: Certificate of Undertaking by the Persons on Record or Engineer on Record as applicable.
- 7 Form No. 11A: Area Statement for Buildings or Form No. 11B: Area Statement for Sub- division and Amalgamation or Form No. 11C: Area Statement for Temporary Construction (whichever is applicable)
- 8 NOC from Appropriate Authority as per Rules as applicable.
- 9 Calculation statement for payment of all relevant Development Permission Fees / Charges or any other charges.
- 10 Photographic Identity Proof of Owner or Developer and person on records.
- 11 Photograph of Building Unit
- 12 Certificate, NOC, opinions as may be required by Competent Authority.
- 13 In case of application for buildings, in addition to above, the following shall be submitted:
 - a) Soil Test Report for buildings with more than 3 floors or frame structures.
 - b) Form No. 2: Certificate of Undertaking by the Structural Engineer on Record.
 - c) Form No. 2: Certificate of Undertaking by the Clerk of Works on Record.
 - d) Form No. 2: Certificate of Undertaking by the QAORF, if applicable.
 - e) Form No. 2: Certificate undertaking for Hazard Safety

C List of Drawings

- 1 Key Plan for both Building Plan and Sub-division & Amalgamation shall be as under:
 - a) Minimum Scale: 1:8000 and
 - b) The plan should explain the boundary and location of the site with respect to neighbourhood landmarks.
- 2 Site Plan for buildings shall be drawn as under:
 - a) Minimum Scale: 1:500 for plots less than 100 hectares and 1:1000 for others.
 - b) Boundaries of the plot and of any contiguous plots belonging to the owner.
 - c) Position of the building unit / plot in relation to the neighbouring streets and street names.
 - d) Direction of north point relative to the plan of buildings.
 - e) Building unit level in relation to the neighbouring street level.
 - f) Building unit number or plot number of the plot on which the building is intended to be erected.
 - g) All existing buildings standing on, over or under the building unit / plot.
 - h) Any existing natural or manmade physical features, such as wells, drains, trees, high tension line, gas pipeline, railway line, etc.
 - i) Proposed use of every building.
 - j) The position of building(s) and construction which the applicant intends to erect in relation to:
 - i The boundaries of the plot and in case where the plot has been partitioned, the boundaries of the portion owned by the applicant and also of the portions owned by others.
 - ii All buildings (with number of storeys and height) and premises adjacent to the plot and of the contiguous land, if any, referred to in (a), and.
 - iii Any street prescribed under the Act and passing through the building unit/s clearly indicating the regular line of streets.
 - iv The area within the regular line of the street not to be built upon but to be added to the street, hatched in green together with its measurements.
 - v Building lines and margins of streets.
 - k) The width and level of the street in front, and of the street, if any, at the side or rear of building clearly indicating the regular line of streets.
 - l) The means of access from the street to the site and all existing and proposed buildings.
 - m) Open space to be left around the building to secure free circulation of air, admission of light and access.
 - n) Open space to be provided under these rules.
 - o) The area of the whole plot and the break-up of Total built-up area on each floor
 - p) Area classified for exemption of built-up area calculations.
 - q) Dimensions and areas of common plot, as required under these rules,
 - r) Parking layout, indicating the parking spaces, access lane, driveway, or ramp.
 - s) Layout and details of rainwater harvesting required under the Development Rules, if any.
 - t) The position of every water closet, privy, urinal, bathrooms, cess pool, well or cistern in connection with the building other than those shown in the building plan.
 - u) The lines of drainage of the building, the size, depth and inclination of every drain and the means to be provided for the ventilation of the drains.
 - v) The position and level of the outfall of the drain, any existing facilities regarding water supply, sewerage etc, diameter and gradient of water supply line, drainage lines for the disposal of storm water as well as for sewerage.
- 3 Site Plan for Subdivision and Amalgamation:
 - a) Minimum scale: 1:500 for building units / plots less than 100 hectares and 1:1000 for others.
 - b) Boundaries of the building unit / plot and of any contiguous plots belonging to the owner, position of the plot in relation to the neighbouring streets and street names and direction of north point relative to the plan of building.
 - c) Building unit level in relation to the neighbouring street level; all existing buildings standing on, over or under the plot.

- d) The position of the building, and of all other buildings (if any) which the applicant intends to erect upon the contiguous land and referred to in (b) in relation to:
 - i) The boundaries of the building unit / plot and in case where the building unit / plot has been partitioned, the boundaries of the portion owned by the applicant and also of the portions owned by others.
 - ii) All streets, buildings (with number of stories and height) and premises adjacent to the building unit / plot and of the contiguous land, if any, referred to in (b), and.
 - iii) If there is no street within a distance of 12 m of the plot, the nearest existing street.
 - iv) Any street prescribed under the Act and passing through the plot/s.
 - v) Building lines and margins of streets
- e) Sub-division of the land or plot or building unit with dimension and area of each of the proposed sub-divisions and their use according to these rules.
- f) The width and length of the proposed streets and internal roads.
- g) Dimensions and Areas of Open space to be left as per the Development Rules
- h) Any existing natural or manmade physical features, such as wells, drains, trees, high tension line, gas pipeline, railway line, etc.
- i) The area of the whole plot and the break-up of covered area on each floor with the calculations for percentage covered as required under the Development Rules,
- j) Dimensions and areas of common plot, as required under these rules, provided in the layout / sub-division of plot.

D Details Drawings to be attached in case of Application for Building

- 1 Detailed Drawings shall be submitted showing the boundary walls and gates.
- 2 Landscape Plan
Minimum Scale: 1:100 for plots less than 500 sq m and 1:500 for others and shall contain the following:
 - a) Space for circulation and parking.
 - b) Paved pathways.
 - c) Existing trees.
 - d) Proposed tree plantation.
 - e) Green areas.
 - f) Unpaved areas.
- 3 Building Plan
The plans, elevations and sections of the proposed building shall be drawn to a scale of 1:100 showing the following details, wherever applicable:
 - a) All floor plans together with the covered area, size and spacing of framing members, size of rooms and the position and width of staircases, ramps and other exit ways, lift wells, lift machine room and lift pit details.
 - b) Built-up area of each dwelling unit, or shop or office space at every floor level.
 - c) Use or occupancy of all parts of the building.
 - d) Exact location of essential services, like WC, sink, bathroom, kitchen, cesspool, water tank, cistern, etc.
 - e) Section drawings clearly showing the size of the footings, thickness of basement wall, wall construction, sizes and spacing of structural members, floor slabs and roof slabs with their materials. The section shall indicate the heights of building and rooms and also the height of the parapet, and the drainage and the slope of the roof. At least one section should be taken through the staircase. Access to the various parts of the building and its appurtenances also should be shown in one section.
 - f) Levels of the site and all floors in relation to the datum or crown level of the access street.
 - g) All elevations.
 - h) Details of service privy, if any.
 - i) Dimensions of the projected portions beyond the permissible building line.
 - j) Terrace plan including cabin structure.
 - k) Parking spaces provided and the parking layout.
 - l) Direction of north point relative to the plan of buildings.

- m) Such other particulars as may be required to explain the proposed building clearly.
- 4 Additional Fire Prevention and Safety Provisions:
Additional fire prevention and safety provisions to be provided in buildings eligible for a Development Permission are specified in Schedule No.4 according to different uses and the height of the building. Details of these shall be indicated in the drawings as required.
- 5 Services Plans:
The outside service pipe for sewerage that is to say from where will they connect with sewerage line if and when sewerage will be provided and from where the rain water coming from back of the plot shall go and to which drain shall be shown. The buildings shall be required to have adequate amount of soak pit and septic tank.
- 6 Specifications
General specifications of the proposed building giving type and grade of material shall be signed by the Architect on Record and the Structural Engineer on Record.

E Detail Drawings to be attached in case of application Sub-division & Amalgamation of Building Unit / Plot:

- 1 Detailed drawing shall be submitted showing the boundary walls and gates.
- 2 Landscape plan

Minimum Scale: 1:100 for plots less than 500 sqm and 1:500 for others and shall contain the following:

- a The space for circulation and parking;
- b Paved pathways.
- c Existing trees.
- d Proposed tree plantation.
- e Green areas.

F Development Permission Fees

Receipt of development permission fees and charges paid as per Schedule No. 5A and of other charges leviable on the building unit shall be attached with the application.

Schedule No. 6B

Drawings, Specifications and Documents to be Submitted with Application for Obtaining / Revising / Revalidating Development Permission / for Brick Kiln, Mining and Quarrying

(Refer Rule No. 4.11.1, 4.13.1, 4.15.1)

The owner / developer shall submit to the Competent Authority the following documents, drawings, and specifications along with application for obtaining and revising a development permission.

A Copies of Documents, Drawings and Specifications

Every drawing, document and report shall be signed by the owner and the Clerk of Works on Record as the case may be and in accordance with these rules.

B List of Documents

- 1 An extract of the record of rights or any other document showing the ownership of the land for this purpose. If the applicant is not the owner of the land, necessary documentary proof shall be provided.
- 2 Zoning Certificate from the Competent Authority
- 3 Form No. 10B: Application for Obtaining / Revising a Development Permission
- 4 True Copies of previous year's development permission
- 5 Form No. 2: Certificate of Undertaking by the Architect on Record or Engineer on Record as applicable.
- 6 Form No. 2: Certificate of Undertaking by the Structural Engineer on Record, as applicable
- 7 Form No. 2: Certificate of Undertaking by the Clerk of Works on Record
- 8 NOC from Appropriate Authority as applicable.
- 9 Calculation statement for payment of all relevant development permission fees or any other charges.
- 10 Photographic identity proof of owner or developer.

C List of Drawings

- 1 A certified site plan showing the land in question along with surrounding area shall be attached.
- 2 Sketch site plan showing:
 - a Area of site presently used.
 - b Area of site proposed to be used.

D Development Permission Fees

Receipt of Development Permission Fees and Charges paid as per Schedule No. 5A and of other charges leviable on the plot shall be attached with the application.

Schedule No. 6C

Format for submission of Documents, Drawings and Specifications

(Refer Rule No. 4.10.1, 4.11.1, 4.12.1, 4.13.1, 4.14.1, 4.15.1, 4.16.1, 6.6.1)

- 1 Copies of Plan and Documents.
- 2 Submission of all documents, certificates, reports, and drawings to the Competent Authority:
 - a Shall represent all facts accurately,
 - b Shall be as per formats and forms prescribed by the Competent Authority,
 - c Shall be neat, clean, and fully legible, and, on durable paper folded in the manner prescribed by the Competent Authority,
 - d Shall be free of any scratches or corrections – small, initiated corrections shall be permitted.
- 3 Standard sizes of all drawings and documents
All drawings and documents shall be of standard sizes as prescribed below:

Table No. S6C – 1: Drawing Sizes

No	Standard Sizes	Trimmed Size (mm)
1	A0	841 X 1189
2	A1	594 X 841
3	A2	420 X 594
4	A3	297 X 420
5	A4	210 X 297
6	A5	148 X 210

- 4 Colours and notations to be followed for all drawings and documents.
All drawings and documents shall follow standard colours and notations as prescribed below:

Table No. S6C – 2: Colours and Notations for Drawings and Documents

No.	Item	Site Plan	Building Plan
1	Plot lines	Thick Black	Thick Black
2	Existing street	Green	
3	Future street, if any	Green dotted	
4	Permissible building line	Thick dotted Black	
5	Open spaces	No colour	No colour
6	Existing works	Blue	Blue
7	Work proposed to be demolished	Yellow hatched	Yellow hatched
8	Proposed work	Red	Red
9	Drainage and sewerage work	Red dotted	Red dotted
10	Water supply work	Black dotted thin	Black dotted thin
11	Work without permission if started on site	Grey	Grey
12	Approved work	Yellow	Yellow

Schedule No. 6D

Drawings, Specifications and Documents to be Submitted with Application for Obtaining Permission for Temporary Construction

(Refer Regulation No. 4.10.1, 4.11.1, 4.12.1, 4.13.1, 4.14.1, 4.15.1, 4.16.1)

The owner / developer shall submit to the Competent Authority the following documents, drawings, and specifications along with application for obtaining and revising a development permission. These are common documents for obtaining permission for Temporary Construction.

A Copies of Documents, Drawings and Specifications

- 1 Two copies of all plans and statements shall be made available along with the notice. Soft copy of the drawings in cad format shall also be submitted.
- 2 All documents, drawings, and specifications to be submitted along with the notice shall be duly signed by the Owner and the appropriate Person on Record and shall indicate their names, contact information and registration number.
- 3 Every drawing, document and report shall be signed by the Owner and the Architect on Record or Civil Engineer on Record, the Structural Engineer on Record, and the Clerk of Works on Record as the case may be and in accordance with the General Development Rules.

B List of Documents which needs to be uploaded or submitted offline

- 1 Satisfactory documentary legal evidence of the Right to Develop or Build Temporary Construction, including original copies of the relevant extract from the Property Register for City Survey Lands or Record of Rights for Revenue Lands as applicable.
- 2 If the applicant is not the owner of the land, necessary documentary proof shall be provided.
- 4 Certified part plan and zoning certificate from the Authority.
- 5 Form No 10A/13: Application for obtaining / revising a development permission.
- 6 Form No. 2: Certificate of Undertaking by the Persons on Record or Engineer on Record as applicable.
- 8 NOC from Appropriate Authority as per Rules as applicable.
- 9 Calculation statement for payment of all relevant Development Permission Fees / Charges or any other charges.
- 10 Photographic Identity Proof of Owner or Developer and person on records.
- 12 Certificate, NOC, opinions as may be required by Competent Authority.
- 13 In case of application for buildings, in addition to above, the following shall be submitted:
 - a Form No. 2: Certificate of Undertaking by the Structural Engineer on Record.
 - b Form No. 2: Certificate of Undertaking by the Clerk of Works on Record.
 - c Form No. 2: Certificate of Undertaking by the QAORF, if applicable.
 - d Form No. 2: Certificate undertaking for Hazard Safety

C List of Drawings

- 1 Key Plan for temporary construction shall be as under:
 - a Minimum Scale: 1:8000 and
 - b The plan should explain the boundary and location of the site with respect to neighbourhood landmarks.
- 2 Site Plan for buildings shall be drawn as under:
 - a Minimum Scale: 1:500 for plots less than 100 hectares and 1:1000 for others.
 - b Boundaries of the plot and of any contiguous plots belonging to the owner.
 - c Position of the building unit / plot in relation to the neighbouring streets and street names.
 - d Direction of north point relative to the plan of buildings.
 - e Building unit level in relation to the neighbouring street level.
 - f Building unit number or plot number of the plot on which the temporary construction is intended to be erected.

- g Any existing natural or manmade physical features, such as wells, drains, trees, high tension line, gas pipeline, railway line, etc.
- h Proposed use of temporary construction.
- i The width and level of the street in front, and of the street, if any, at the side or rear of temporary construction clearly indicating the regular line of streets.
- j The means of access from the street to the site and all existing and proposed temporary construction.
- k Open space to be left around the temporary construction to secure free circulation of air, admission of light and access.
- l Open space to be provided under these rules.
- m The area of the whole plot and the break-up of Total temporary construction area

F Development Permission Fees

Receipt of development permission fees and charges paid as per Schedule No. 5C and of other charges leviable on the building unit shall be attached with the application.

Schedule No. 7A

Information to be Displayed on Site

(Refer Rule No. 5.2)

It shall be the responsibility of the Owner or Developer and the Clerk of Works on Record to erect a notice board on the site of development displaying the key information pertaining to the Building Unit.

Information that shall be displayed on the Notice Board:

- 1 Name and address of the proposed building.
- 2 Sanctioned Use of the Building (use as sanctioned in the Development Permission).
- 3 Survey No, City Survey No, Block No., Final Plot No., Sub Plot/ Property No., and complete address of the plot.
- 4 Name of the Owner(s) / Developer(s)
- 5 Names and Registration Numbers of duly appointed Persons on Record on the project:
 - a Architect on Record/ Engineer on Record b. Structural Engineer on Record, and
 - b Clerk of Works on Record
 - c Supervisor of works on Record
 - d Qualified Agency on Record for Fire, as applicable

Failure to comply with the above requirements may result in cancellation of the Development Permission

Schedule No. 7B

Documents and Drawings to be Maintained on Site During Period of Construction

(Refer Rule No. 5.3)

It shall be the responsibility of the Owner or Developer and the Clerk of Works on Record to keep all the documents and drawings which are listed below at the site at all times during the entire Period of Construction from commencement to completion. These documents should be made available to any authorised officer of the Competent Authority inspecting the site for the purpose of enforcing the General Development Rules.

The following documents shall be kept on site during construction:

- 1 A set of the sanctioned drawings.
- 2 A copy of the valid Development Permission

Schedule No. 7C

Stages of Construction Work for which Notice for Progress of Construction to be Submitted to the Competent Authority

(Refer Rule No. 5.5.3)

The Architect on Record or Engineer on Record and the Owner or Developer shall be responsible for notifying the Competent Authority of construction having been completed up to the stages specified below. They shall also certify that the construction has been carried out in compliance with sanctioned drawings and to the Development Rules, using the format as prescribed in Form No. 20:

- 1 Lower Basement Slab Level
- 2 Plinth level
- 3 Ground Floor
- 4 Middle storey (in case of buildings above 15 m / 17.5 m (with stilt) in height)
- 5 Last storey (when the last structural roof has been completed)

Schedule No. 8

Inspection Requirements

(Refer Rule No. 5.6, 6.5.3)

Table No. S8A – 1: Principles of Risk Categorization (Definition of Consequence Class) and Inspection Requirements

No.	Consequences Class	Description	Use and Building type	Design Supervision Level	Supervision Requirements	Minimum recommended requirements for checking of calculations, drawings, and specifications.	Minimum requirements for Inspection of implementations and the insurance requirements.	Minimum Experience required
(1)	(2)	(3)	(4)	(5)	(6)	(7)	(8)	(9)
1	CC1	<ul style="list-style-type: none"> • Low consequence for loss of human life. • Negligible economic, social, or environmental consequences, • Developed, owned, and maintained by single owner 	<p>Following development carried out in all areas other than Seismic Zone 5:</p> <p>Dwelling 1 Agro-Based Storage (Agriculture 2)</p>	SL1	Supervision by the owner and POR	<p>Self-checking: Checking performed by the person who has prepared the design. Self-certification of design by the architect and the structural engineer appointed by the owner.</p>	<p>Self-certification by the architect and the structural engineer appointed by the owner for carrying out the construction as per drawings and specifications and for which the plans are approved. The POR shall for all levels submit the reports and submission of completion plan. No inspection to be carried out by the Inspector of the competent authority and shall issue the building use permission based on the documents supplied by the owner and POR The competent authority shall not insist on the insurance for the building.</p>	As per regulation no. AOR, EOR and SEOR registration

No.	Consequences Class	Description	Use and Building type	Design Supervision Level	Supervision Requirements	Minimum recommended requirements for checking of calculations, drawings, and specifications.	Minimum requirements for Inspection of implementations and the insurance requirements.	Minimum Experience required
(1)	(2)	(3)	(4)	(5)	(6)	(7)	(8)	(9)
2	CC2	Low consequence for loss of human life; small or negligible economic, social, or environmental consequences, but the developer, owner or the person who may maintain may not the same person.	For the following development where the building height does not exceed 13.5m: Dwelling 2 Mercantile 1	SL2	Normal supervision by POR and the Competent Authority	Self-checking: Checking performed by the person who has prepared the design. Self-certification of design by the architect and the structural engineer appointed by the owner.	Self-certification by the architect and the structural engineer appointed by the owner for carrying out the construction as per drawings and specifications and for which the plans are approved. The POR shall for all levels submit the reports and submission of completion plan. Inspection to be carried out by the Inspector of the competent authority at the plinth level and at time when the owner makes an application for getting building use permission. The building use permission shall issue based on the inspection report and the documents supplied by the owner and POR. The competent authority shall not insist on the insurance for the building.	One year after registration as AOR, EOR, SEOR for respective task
3	CC3	Medium consequence for loss of human life; considerable economic,	For the following development	SL3	Normal supervision by POR and the	Checking by different persons in	Certification by the architect and the structural engineer appointed by the	Two years after registration as AOR for respective task

No.	Consequences Class	Description	Use and Building type	Design Supervision Level	Supervision Requirements	Minimum recommended requirements for checking of calculations, drawings, and specifications.	Minimum requirements for Inspection of implementations and the insurance requirements.	Minimum Experience required
(1)	(2)	(3)	(4)	(5)	(6)	(7)	(8)	(9)
		social, or environmental consequences	where the building height does not exceed 25m: Dwelling 3 Dwelling 4 Hospitality 2 Mercantile 1 Mercantile 2 Mercantile 3 Assembly 4 Health 2		Competent Authority	accordance with the procedure prescribed in these rules no 3, 5, 6 and 7. Plinth and occupancy inspection and certification by structure designer.	owner for carrying out the construction as per drawings and specifications and for which the plans are approved. The POR shall for all levels submit the reports and submission of completion plan. Inspection to be carried out by the Inspector of the competent authority at the at all levels as required in regulation no 4, 5 and 6. The building use permission shall issue based on the inspection reports and the documents supplied by the owner and POR. The competent authority shall ask the owner to seek insurance coverage for the building for minimum 5 years and then only issue the building use permission.	
4	CC4	High consequence for loss of human life; High consequences for economic, social, or	For the following development where the	SL4	Extended supervision	Checking by different persons in accordance with	Certification by the architect and the structural engineer appointed by the owner for carrying out the	Three year after registration as AOR for respective task

No.	Consequences Class	Description	Use and Building type	Design Supervision Level	Supervision Requirements	Minimum recommended requirements for checking of calculations, drawings, and specifications.	Minimum requirements for Inspection of implementations and the insurance requirements.	Minimum Experience required
(1)	(2)	(3)	(4)	(5)	(6)	(7)	(8)	(9)
		environmental consequences	building height exceeding 25m but up to 45m: Hospitality 1 Hospitality 2 Hospitality 3 For the following development where the building height exceeding 13.5m but up to 45m: Service Establishment 1 Service Establishment 2 Mercantile 1 Mercantile 2 Storage For the following development having up to 45m: Education 1			the procedure prescribed in these rules no 3, 5, 6 and 7. Plinth and occupancy inspection and certification by structure designer.	construction as per drawings and specifications and for which the plans are approved. The POR shall for all levels submit the reports and submission of completion plan. Inspection to be carried out by the Inspector of the competent authority at the at all levels as required in regulation no 4, 5 and 6. The building use permission shall issue based on the inspection reports and the documents supplied by the owner and POR The competent authority shall ask the owner to seek insurance coverage for the building for minimum 15 years and then only issue the building use permission.	

No.	Consequences Class	Description	Use and Building type	Design Supervision Level	Supervision Requirements	Minimum recommended requirements for checking of calculations, drawings, and specifications.	Minimum requirements for Inspection of implementations and the insurance requirements.	Minimum Experience required
(1)	(2)	(3)	(4)	(5)	(6)	(7)	(8)	(9)
			Education 2 Education 3 Assembly 1 Assembly 2 Assembly 3 Assembly 4 Religious Recreation 1 Recreation 2 Sports and Leisure Industrial 1 Industrial 2 Industrial 3 Agriculture 1 Agriculture 2 Temporary Use Utility Public office Health 1 Health 2 Health 3 Health 4 Transport Storage Environmental Preservation 1 Environmental Preservation 2 Environmental					

No.	Consequences Class	Description	Use and Building type	Design Supervision Level	Supervision Requirements	Minimum recommended requirements for checking of calculations, drawings, and specifications.	Minimum requirements for Inspection of implementations and the insurance requirements.	Minimum Experience required
(1)	(2)	(3)	(4)	(5)	(6)	(7)	(8)	(9)
			Preservation 3 Cremation and Burial All others not specified.					

Schedule No. 9

Documents and Drawings to be Submitted along with the Application for Occupancy Certificate

(Refer Rule No. 6.5.1)

The following documents and drawings shall be submitted along with the Application for Occupancy Certificate for a building:

A Documents and Drawings:

- 1 One set of Completion Plans and as-built drawings, duly certified by POR.
- 2 Form No. 2: Certificates of Undertaking by the Architect on Record or Engineer on Record.
- 3 Form No. 2: Certificates of Undertaking by the Structural Engineer on Record.
- 4 Form No. 2: Certificates of Undertaking by the Clerk of Works on Record.
- 5 Form No. 2: Certificates of Undertaking by the QAORF.
- 6 Clearance from Fire Officer, as applicable and mentioned in Schedule No. 4.
- 7 Certificate of Lift Inspector for buildings taller than 15 m.
- 8 A copy of valid Registration Certificate of the Persons on Record issued by the Competent Authority.

B Occupancy Certificate Fees and Charges:

Receipt of Occupancy Certificate Fees and Charges paid as per Rule No.6.5.2 and Schedule No. 5B and of other charges leviable on the building-unit shall be attached with the application.

Schedule No. 10

Schedule for Maintenance and Inspection for Structural Stability and Fire Safety

(Refer Rule No. 16.2, 16.7.2, 19.1.2)

Class 1 Buildings: All types of framed structures, factory buildings, special buildings, buildings for educational use such as schools, colleges, etc; hostels and other public buildings.

Class 2 Buildings: Masonry walled residential buildings with height more than 10 m.

A Structural Stability

The interval at which buildings are to be examined and a Structural Inspection Report in Format as per Form 15 submitted to Competent Authority shall be as under:

For Class 1 buildings which are erected fifteen years earlier from the date on which these Rules has come into force or which becomes five years old thereafter:

- 1 Within three years from the coming into force of these Rules
- 2 Thereafter at the interval of every fifteen years from the date of submission of the first report

For Class 2 buildings which are erected fifteen years earlier from the date on which these Regulation has come into force or which become fifteen years old thereafter:

- 1 Within five years from the coming into force of these Rules
- 2 Thereafter at the interval of every fifteen years from the date of submission of the first report

B Fire Safety

The interval at which buildings are to be examined by Fire Officer or QAORF and a Fire Safety Certificate as stipulated in Form 27 be submitted to Competent Authority shall be as under:

- 1 Within one year from the coming into force of these Rules
- 2 Thereafter at the interval of every six months from the date of submission of the first certificate.

Schedule No. 11

Documents and Fees Required with Application for Advertising Display & Communication Infrastructures

(Refer Rule No. 12.1)

1 Advertising display

The Owner / Developer shall submit to the Competent Authority the following documents for erecting Advertising Display:

A List of documents

- 1 Receipt of Fees paid and of other charges leviable shall be attached with the application.
- 2 Certificate from Registered Structural Engineer for the stability, safety of display structure to be erected.
- 3A For tender cases the documents to be submitted are:
 - a Shop Establishment Number
 - b Sale tax number
 - c Income tax clearance certificate.
- 3B For Private property cases:
 - a Lay-out plan.
 - b Structural detail plan.
 - c NOC from property holder.
 - d 2 copies of photograph of the actual site.
 - e Electricity Bill of last month.
 - f Property Tax Bill.
 - g Agreement copy.
 - h 1/14 nakal
 - i Ekrarnama

B Deposit, fees, and penalty:

- 1 The fees for erection and maintenance of the Advertising Display shall be charged as decided by Competent Authority. The fees shall be paid by the applicant in advance, for the calendar year or part thereof as may be prescribed by the Competent Authority.
- 2 Competent authorities may also decide penalty norms for non-compliance of Rules specified for Advertising Display Structures of various types.

2 Communication infrastructures

The Owner / Developer shall submit to the Competent Authority the following documents for erecting Communications Infrastructure:

A List of documents

- 1 Receipt of Fees paid and of other charges leviable shall be attached with the application.
- 2 Structural Stability Certificate from Registered Structural Engineer for the stability, safety of display structure to be erected which shall be the liability of the Owner and the Registered Structural Engineer
- 3 Permission from the “Standing Advisory Committee on Radio Frequency Allocation” (SACFA) issued by Ministry of Telecommunications.

B Deposit and fees:

The fees for erection of the Communication Infrastructure shall be charged as revised by Competent Authority from time to time.

Schedule No. 12
List of Recommended Trees

(Refer Regulation No. 17.5)

Following list of trees are recommended for their suitability regarding shade and foliage:

Table No. S12 – 1: List of Trees

No.	Common Name
1	Cocous Nucifera
2	Mangifera Indica
3	Palm Oil Tree
4	Polyalthia
5	Phoenix Sylvestris
6	Terminalia tomentosa
7	Butea Frondosa
8	Tectona Grandis
9	Bridelia Retusa
10	Anogeissus Latifolia
11	Lanea Coromandelica
12	Diospyros Melanoxylon
13	Madhuca Indica
14	Borassus Flabellifer
15	Cascabela thevetia
16	Ficus Benghalensis
17	Azadirachta Indica
18	Delonix Regia
19	Saraca Asoca
20	Ficus Religiosa
21	Syzygium Cumini
22	Tamarindus Indica
23	Abizia Saman
24	Madhuca Longifolia
25	Terminalia Catappa
26	Erythrina Variegata
27	Casuarina Equisetifolia
28	Ziziphus Jujuba
29	Ficus Virens
30	Tectona grandis
31	Dalbergia Sissoo
32	Santalum Album
33	Senegalia Catechu
34	Swoetenia

Schedule No. 13

Standalone Multi-Level Public Parking

Standalone multi-level public parking may be permissible in residential, mercantile, public office, industrial, recreational, assembly and transportation land use classification. 5% of the built-up area of the parking structure may be used for commercial activity. Other planning norms for such standalone parking buildings shall be as below:

- 1 Front / Road Margin: 12 metres.
- 2 All other three sides: 7.5 metres.
- 3 Building height: To be determined in each case by the Competent Authority.
- 4 Parking floors: Where the plot size is not less than 1000 sq m cover parking with a clear height of not more than 2.4 metres may be permitted on any floor of the building according to the requirement of the FAR. If such parking is provided on the entire floor area, then such parking floor would not be included in the height of the building.

Forms

Form No. 1
Application for Registering as Person on Record

(Rule No. 3.2.1)

To,

The Competent Authority

- 1 Name:
- 2 Local Address:
- 3 Permanent Address:
- 4 Telephone/Fax No:
- 5 Qualification:
- 6 Membership of Professional:
- 7 Associations (Indicate appropriate professional affiliations)
- 8 Experience (No. of years):
- 9 Previous year's Registration No.
- 10 Name of Employer: (if employed)
- 11 PAN Number:
- 12 Aadhar Number:
- 13 Bank Account Details:

Sir/Madam,

Kindly register me as (Architect on Record / Civil Engineer on Record / Structural Engineer on Record / Clerk of Works on Record / Supervisor on Record / Developer) of the Competent Authority. I meet with the minimum qualifications and competence requirements as specified in Rule No. 3.2.1 and Schedule No. 1. Relevant documents attesting to the same are attached herewith.

I hereby undertake to abide by all rules, regulations, standing orders, requisitions and instructions given by the Competent Authority and shall carry out my responsibilities as prescribed in the General Development Rules. I also understand that if I fail to perform my responsibilities as above, the Competent Authority reserves the right to de- register me, forfeit my security deposit and take other appropriate action as defined in the General Development Rules as per the provisions of the Act.

Name of the Applicant:

Signature:

Date:

Form No. 2

Certificate of Undertaking for Persons on Record

(Refer Rule No. 3.3.2, 3.3.3, 3.3.4, 3.3.7)

To,

The Competent Authority

Proposed Development:

(Title of the work)

Plot No /Sub Plot No.: _____ Area of the Plot / Sub Plot: _____ (sq m)
Survey No.: _____ Area of Survey No.: _____ (sq m)
Final Plot No.: _____ Area of Final Plot No.: _____ (sq m)

Full Address of Proposed Development:

Name of the Owner / Developer: _____

Sir / Madam,

A I am currently registered as Architect on Record with the Competent Authority as per Rule Nos. 3.3.1 and 3.3.2.

I, hereby certify that I am appointed as the Architect on Record to prepare the plans, sections and details as required under the General Development Rules for the above-mentioned project and that I have prepared and signed the same and that the execution of the project shall be carried out under my direction and supervision of supervisor or owner, as per the approved drawings. I am fully conversant with the provisions of the Rules, which are in force, and about my duties and responsibilities under the same and I undertake to fulfil them in all respects, except under the circumstances of natural calamities.

I fully understand that in case my certificate/s is found to be false, or if it is found that I have not fulfilled my responsibilities as prescribed therein, the Competent Authority shall be at liberty to penalize me as per the provisions of the Act.

B I am currently registered as Civil Engineer on Record with the Competent Authority as per Rule Nos. 3.3.1 and 3.3.3.

I, hereby certify that I am appointed as the Civil Engineer on Record to prepare the plans, sections and details as required under the General Development Rules for the above-mentioned project and that I have prepared and signed the same and that the execution of the project shall be carried out under my direction and supervision of supervisor or owner, as per the approved drawings. I am fully conversant with the provisions of the Rules, which are in force, and about my duties and responsibilities under the same and I undertake to fulfil the min all respects, except under the circumstances of natural calamities.

I fully understand that in case my certificate/s is found to be false, or if it is found that I have not fulfilled my responsibilities as prescribed therein, the Competent Authority shall be at liberty to penalize me as per the provisions of the Act.

C I am currently registered as Structural Engineer on Record with the Competent Authority as per Rule No. 3.3.1 and 3.3.4.

This is to certify that I am appointed as the Structural Engineer on Record to prepare the structural report, structural details, and structural drawings as required under the General Development Rules for the above-mentioned project. I am fully conversant with the Rules and of my duties and responsibilities under the Rules and assure that I shall fulfil them in all respects. I have prepared and signed the structural design and drawings of the proposed building as per the prevailing Indian Standard Specifications and further certify its structural safety and stability in design.

I fully understand that in case my certificate/s is found to be false, or if it is found that I have not fulfilled my responsibilities as prescribed therein, the Competent Authority shall be at liberty to penalize me as per the provisions of the Act.

D I, am currently registered as Clerk of Works on Record with the Competent Authority as per Rule Nos. 3.3.1 and 3.3.5.

This is to certify that I am appointed as the Clerk of Works on Record for the above-mentioned project. I am fully aware of my duties and responsibilities under the Rules and assure that I shall fulfil them in all respects. I shall undertake all necessary measures, including but not limited to adequate inspection during construction, to ensure that the construction of the building is undertaken in accordance with the detailed design and specifications provided by (name of the Architect on Record) and (name of the Structural Engineer on Record), and, with the sanctioned design and specifications.

- I undertake not to supervise more than ten works at a given time as provided in Development Rules.
- I undertake not to supervise work simultaneously at one point of time on any other sites during my supervision of the execution of this work.

I fully understand that in case my certificate/s is found to be false, or if it is found that I have not fulfilled my responsibilities as prescribed therein, the Competent Authority shall be at liberty to penalize me as per the provisions of the Act.

E I, am currently registered as Supervisor of Works on Record with the Competent Authority per Rule Nos. 3.3.1 and 3.3.6.

This is to certify that I am appointed as the supervisor of Works on Record for the above-mentioned project. I am fully aware of my duties and responsibilities under the Rules and assure that I shall fulfil them in all respects. I shall undertake all necessary measures, including but not limited to adequate inspection during construction, to ensure that the construction of the building is undertaken in accordance with the detailed design and specifications provided by (name of the Architect on Record) and (name of the Structural Engineer on Record), and, with the sanctioned design and specifications.

- I undertake not to supervise more than ten works at a given time as provided in Development Rules.
- I undertake not to supervise work simultaneously at one point of time on any other sites during my supervision of the execution of this work.

I fully understand that in case my certificate is found to be false, or if it is found that I have not fulfilled my responsibilities as prescribed therein, the Competent Authority shall be at liberty to penalize me as per the provisions of the Act.

F I, am currently registered as Qualified Agency on Record for Fire with the Fire Officer per Rule Nos. 3.3.1 and 3.3.7

I is hereby certify that I have been appointed as the Qualified Agency on Record for Fire of the proposed building. I am fully conversant with the Rules and of my duties and responsibilities under the Rules and as sure that I shall fulfil the min all respects. I have prepared and signed the fire safety drawings of the proposed building as per the Rules and further certify its fire safety.

I, is fully understand that in case my certificate is found to be false, or if it is found that I have not fulfilled my responsibilities as prescribed there in, the Competent Authority shall be at liberty to penalize me as per the provisions of the Act.

As per Rule No. 16 and Schedule 6A of these General Development Rules we all undersigned:

- 1 Certify that the building plans submitted for approval satisfy the safety requirements as stipulated under Rule No. 16 and the information given therein is factually correct to the best of our knowledge and understanding.
- 2 Certify that the structural design including safety from hazards based on soil conditions shall be duly incorporated in the design of the building and these provisions shall be adhered to during the construction.

Name of AOR
Registration No.:
Address:
Tel. No.:
Signature:
Date:

Name of EOR:
Registration No.:
Address:
Tel No.:
Signature:
Date:

Name of SEOR
Registration No.:
Address:
Tel. No.:
Signature:
Date:

Name of COWOR:
Registration No.:
Address:
Tel No.:
Signature:
Date:

Name of SOR:
Registration No.:
Address:
Tel. No.:
Signature:
Date:

Name of QAORF:
Registration No.:
Address:
Tel No.:
Signature:
Date:

Signature of Owner /Developer with date:
Name:
Address:

Form No. 3

Notice to the Competent Authority of Non-Compliance of Building to Sanctioned Design and Specifications

(Refer Rule Nos. 3.3.2, 3.3.3, 3.3.4, 3.3.5, 3.3.6, 3.3.7)

To,

The Competent Authority

Proposed Development:

(Title of the work)

Plot No /Sub Plot No.: _____ Area of the Plot / Sub Plot: _____ (sq m)
Survey No.: _____ Area of Survey No.: _____ (sq m)
Final Plot No.: _____ Area of Final Plot No.: _____ (sq m)

Full Address of Proposed Development:

Name of the Owner / Developer: _____

Sir / Madam,

I am currently registered as (Architect / Civil Engineer / Structural Engineer / Clerk of Works Supervisor of Works / Qualified Agency for Fire on Record with the Competent Authority. I have been appointed as (Architect / Civil Engineer / Structural Engineer / Clerk of Works / Supervisor of Works / Qualified Agency on Record for Fire) on Record for the proposed building.

This is to bring to your notice that construction of the building is not being undertaken in accordance with the sanctioned design and specifications and/or with the following General Development Rules. Details of non-compliance are as follows:

- 1
- 2
- 3

Name: _____

Registration No.: _____

Address: _____

Tel. No.: _____

Email: _____

Signature: _____

Date: _____

Form No. 4

Notice to the Competent Authority of Discontinuation as Person on Record

(Refer Rule Nos. 3.3.2, 3.3.3, 3.3.4, 3.3.5, 3.3.6, 3.3.7)

To,

The Competent Authority

Proposed Development:

(Title of the work)

Plot No /Sub Plot No.: _____ Area of the Plot / Sub Plot: _____ (sq m)

Survey No.: _____ Area of Survey No.: _____ (sq m)

Final Plot No.: _____ Area of Final Plot No.: _____ (sq m)

Full Address of Proposed Development:

Name of the Owner / Developer: _____

Sir / Madam,

This is to bring to your notice that I have been relieved of my responsibility / have relieved myself of my responsibility as (Architect / Civil Engineer / Structural Engineer / Clerk of Works / Supervisor of Works/ Qualified Agency on Record for Fire for the proposed building, with effect from _____ (date).

I wish to place on record that with effect from the said date, I shall neither be associated with this building nor be responsible for its compliance to the sanctioned design and specifications and to the Development Rules.

Name: _____

Registration No.: _____

Address: _____

Tel. No.: _____

Email: _____

Signature: _____

Date: _____

Form No. 5
Notice of Cancellation of Development Permission

(Refer Rule No. 4.4.3)

To

File No: _____

Dated: _____

Proposed Development:

(Title of the work)

Plot No /Sub Plot No.: _____ Area of the Plot / Sub Plot: _____ (sq m)

Survey No.: _____ Area of Survey No.: _____ (sq m)

Final Plot No.: _____ Area of Final Plot No.: _____ (sq m)

Full Address of Proposed Development:

Name of the Owner / Developer: _____

Sir,

This is to notify you that the Direct / Development Permission No. _____ issued /granted on date: _____ by _____ AOR / CEA / PDA been cancelled by the Chief Executive Authority / Member Secretary on the following grounds:

- 1.
- 2.

Please note that no further construction may be undertaken on the plot. A new Development Permission has to be obtained before undertaking any further construction on the plot.

Yours faithfully
The Competent Authority

Form No. 6
Notice to Stop Unauthorized Development

(Refer Rule No. 4.7.2)

To

File No: _____

Dated: _____

Proposed Development:

(Title of the work)

Plot No /Sub Plot No.: _____ Area of the Plot / Sub Plot: _____ (sq m)

Survey No.: _____ Area of Survey No.: _____ (sq m)

Final Plot No.: _____ Area of Final Plot No.: _____ (sq m)

Full Address of Proposed Development:

Name of the Owner / Developer: _____

Sir,

This is to notify you the development constructed on the plot is Unauthorized Development on the following grounds:

1

2

.....

Please ensure that such development is stopped with immediate effect and that no use may be made of the development.

OR

This is to notify you that part of the development specified below, constructed on the plot is Unauthorized Development on the following grounds:

(Description of part of the development that is Unauthorized Development)

1

2

.....

Please ensure that such construction is stopped with immediate effect and that no use may be made of the part of the development specified above.

OR

This is to notify you that the development being undertaken on the plot is Unauthorized.

Development on the following grounds:

1

2

I hereby order that the development on the plot be stopped with immediate effect.

Yours faithfully

The Competent Authority

Form No. 7
Direct Development Permission

(See Rule No. 4.10.1)

To,

The Competent Authority

Proposed Development:

(Title of the work)

Plot No /Sub Plot No.: _____ Area of the Plot / Sub Plot: _____ (sq m)
Survey No.: _____ Area of Survey No.: _____ (sq m)
Final Plot No.: _____ Area of Final Plot No.: _____ (sq m)

Full Address of Proposed Development:

Name of the Owner / Developer: _____

Sir,

I am currently registered as Architect on Record with Competent Authority and am fully conversant with the General Development Rules. I have been appointed as the Architect on Record of the proposed development. I hereby certify that I have verified the designs and specifications of the proposed development and certify that they comply with the General Development Rules.

I hereby issue a Direct Development Permission for construction of the proposed Development. This Direct Development Permission is to be read in conjunction with all other documents and drawings which are enclosed as per the provisions of Rule No 4.12.1 and its Schedules, and that all such documents, drawings, and specifications form part of this Direct Development Permission.

I further assure that the owner shall:

- 1 Comply all Rules required for safety
- 2 Submit the plans and documents to the Competent Authority.
- 3 Commence development only after the registration of this permission.

I fully understand that in case my certificate is found to be false, or if it is found that the Direct Development Permission issued by me is inconsistent with the General Development Rules or that I have not fulfilled my responsibilities as prescribed therein, the PDA / CA shall be at liberty to penalize me / revoke my registration as per the provisions of the Act and Rules.

Name of the AOR: _____

Registration No.: _____

Address: _____

Tele. No.: _____

Signature: _____

Date: _____

Form No. 8

Application for Registering Issue of Direct Development Permission

(See Rule No. 4.10.1)

To,

The Competent Authority

Proposed Development:

(Title of the work)

Plot No /Sub Plot No.: _____ Area of the Plot / Sub Plot: _____ (sq m)
Survey No.: _____ Area of Survey No.: _____ (sq m)
Final Plot No.: _____ Area of Final Plot No.: _____ (sq m)

Full Address of Proposed Development:

Name of the Owner / Developer: _____

Sir,

I am currently listed as Architect on Record with Competent Authority. I am fully conversant with the General Development Rules.

I have been appointed as the Architect on Record of the proposed development. I hereby certify that I have verified the design and specifications of the proposed development and certify that they comply with the General Development Rules of the PDA.

I have issued a Direct Development Permission for construction of the proposed Development and hereby apply for registration of the same on the records of the PDA.

I fully understand that in case my certificate is found to be false, or if it is found that the Direct Development Permission issued by me is inconsistent with the General Development Rules of the PDA shall be at liberty to penalize me.

Name of the AOR: _____

Registration No.: _____

Address: _____

Tele. No.: _____

Signature: _____

Date: _____

Form No. 9

Registration or Cancellation of Direct Development Permission / Revised Direct Development Permission / Revalidated or Extended Direct Development Permission

(See Rule. No. 4.10.3, 4.12.3, 4.14.3)

To

File No: _____

Dated: _____

Proposed Development:

(Title of the work)

Plot No /Sub Plot No.: _____ Area of the Plot / Sub Plot: _____ (sq m)

Survey No.: _____ Area of Survey No.: _____ (sq m)

Final Plot No.: _____ Area of Final Plot No.: _____ (sq m)

Full Address of Proposed Development:

Name of the Owner / Developer: _____

Sir,

With reference to your application for registering issue of _____ (Direct Development Permission / Revised Direct Development Permission / Revalidated Direct Development Permission) on _____ (date), I am directed to inform you that the Issue of Direct Development Permission / Revised Direct Development Permission / Revalidated Direct Development Permission has been registered on the records of the PDA on _____ (date).

OR

With reference to your application for registering issue of _____ (Direct Development Permission / Revised Direct Development Permission/ Revalidated Direct Development Permission) on _____ (date), I am directed to inform you that the Direct Development Permission/ Revised Direct Development Permission/ Revalidated Direct Development Permission issued by you, has been cancel on the following grounds:

- 1.
- 2.

Yours faithfully
The Competent Authority

Form No. 10A

Application for Development Permission for Building / Layout / Subdivision / Amalgamation

(Refer Rule No. 4.11.1)

Application for development permission under sections 44, 49 and 66 of The Dadra and Nagar Haveli and Daman & Diu Town & Country Planning Act, 1974, as the case may be.

To,

The Competent Authority

I / We hereby apply for permission for the following:

- Development on building unit
- Development of layout
- Subdivision of building unit
- Amalgamation of building unit

The information sheet is enclosed with this application. All drawings and documents as per Schedule No. 6A are enclosed with this application.

The names of the persons on record are as under:

- a) The plans are prepared by Registered Architect / Civil Engineer: _____
(Please specify the license number and date of expiry)
- b) The structural report, details and drawings are prepared and supplied by Registered Structural Engineer: _____ (if Applicable)
(Please Specify the license number and date of expiry)
- c) The site supervision of the construction work will be done by Registered Clerk of Work: _____ (if Applicable)
(Please Specify the license number and date of expiry)

I shall be responsible for ensuring that the development complies with the Development Rules framed by the Competent Authority under the provisions of the Act. I shall fulfil my duties and responsibilities in accordance with the provisions of the Development Rules.

Signature of Owner / Developer or Authorized Agent of Owner _____

Date: _____

Table No. F10A – 1: Information Sheet with Application for Development Permission for Building / Layout / Amalgamation / Subdivision

No.	Title	Details			
1	Ownership Details				
	1.1	Applicant's Name			
	1.2	Postal Address for correspondence			
	1.3	Address of Land in Question			
	1.4	Applicants interest / title in land with respect of record of rights			
2	Land Details - Legal				
	2.1	Land Description			
	2.2	Village Name			
	2.3	TPS/Revenue village / Gamtal			
	2.4	FP No/ Revenue Survey No./ C S No			
	2.5	Sub-Plot No/Tenement No			
	2.6	Ward			
	2.7	Zone			
	2.8	Details of Approval before taken			
3	Type of Case for Application				
	3.1	New / Revision / Reopen / Renewal/ Addition/Alteration			
4	Land Occupancy Type Existing		Tick as applicable	Land Occupancy Type- Proposed	Tick as applicable
	4.1	Vacant		Vacant	
	4.2	Partly - Built		Partly - Built	
	4.3	Fully - Built		Fully - Built	
5	Site Details				
	A Width of Road Abutting the Site		TP Road	Non-TP Road/DP Road/Other Road	BRTS Corridor
	5.1	Road 1: Front Side			
	5.2	Road 2: Other than Front Side			
	5.3	Road 3: Other than Front Side			
	5.4	Road 4: Other than Front Side			
	B Seismic Details		Yes/ No	Zone No.	Details
	5.5	Seismic Zone			
	C Water Supply		Available by Local Government/ Authority	Bore Well	
	5.6	Water Supply Facility in Building-unit			
	D Drainage		Available by Local Government/ Authority	Not Available	
	5.7	Drainage Facility in Building- unit			
	E Storm Water		City Network	Percolation Pit/ Percolating Well/ Recharge Pit	
	5.8	Storm Water Facility in Building-unit			
	F Solid Waste Disposal		Local Government/ Authority	None	
5.9	Solid Waste Disposal Facility in Building-unit				
G Electricity		Available by Torrent/GEB /Other	None		
5.10	Electricity facility in Building- unit				
6	Land-Use Details				

No.	Title	Details				
	A Existing Use	Details				
		Use Sub - type	Total Units	Max. No of Floor	Max. Building Height.	Total Built-up Area
6.1	Residential					
6.2	Commercial					
6.3	Mixed Use					
6.4	Industrial					
6.5	Others (please specify)					
	B Proposed Use	Details				
6.6	Residential					
6.7	Commercial					
6.8	Mixed Use					
6.9	Industrial					
6.10	Others (please specify)					
Attachments: Annexure as above						

Form No. 10B**Application for Development Permission for Brick Kiln, Mining and Quarrying**

(Refer Rule No. 4.11.1)

Application for permission of Brick-kiln, Mining and Quarrying under Section 44 The Dadra and Nagar Haveli and Daman & Diu Town & Country Planning Act, 1974

To,

The Competent Authority

I/We hereby apply for permission for development as described below. I/We are applying for development on this land for the first time. I/We certify that all terms and conditions laid down in the development permission granted during last year/previous years have been scrupulous observed.

Table No. F10B – 1: Application for Development Permission for Brick Kiln, Mining and Quarrying

No	Title	Details
1	Ownership Details	
	1.1	Applicant's Name
	1.2	Postal Address for correspondence
	1.3	Address of Land in Question
	1.4	Applicants interest/title in land with respect of record of rights
2	Land Details - Legal	
	2.1	Land Description
	2.2	Village Name
	2.3	TPS/ Revenue Village/ Gamtal
	2.4	FP No/ Revenue Survey No./ C S No
	2.5	Sub-Plot No/Tenement No
	2.6	Details of 1/14 attached
	2.7	Ward
	2.8	Zone as per sanctioned DP
	2.9	Details of Approval before taken.
3	Was land in question used for brick-kiln/mining/quarrying in the past?	
	3.1	Yes/ No If YES, please specify details
4	Whether Development Permission and N.A. permission were obtained in past?	
	4.1	Yes/ No If YES, please specify details
5	Total area of land in question:	
6	Present Use of Land:	
7	Proposed Use of Land:	
8	Mention the area of land used for above mentioned uses so far (sq m) Indicate the same on-site plan	
9	Mention the proposed area to be used. (sqm) Indicate the same on-site plan	
10	Mention the duration for which permission is sought (in month / year)	
	10.1	Mention time-limit for completion or termination of such use (in month / year)
11	For Renewal of Permission	
	11.1	Case No. and Date of previous Permission
	11.2	Amount of the Security Deposit
Attachments: Annexure as above		

Signature of Owner/Developer or Authorized agent of owner: _____

Date: _____

Form No. 10C

Application for Development Permission for Temporary Construction

(Refer Rule No. 4.16.1)

Application for development permission under sections 44, 49 and 66 of The Dadra and Nagar Haveli and Daman & Diu Town & Country Planning Act, 1974, as the case may be.

To,

The Competent Authority

I / We hereby apply for permission for the Development Permission for Temporary Construction

The information sheet is enclosed with this application. All drawings and documents as per Schedule No. 6D are enclosed with this application.

The names of the persons on record are as under:

- a) The plans are prepared by Registered Architect / Civil Engineer: _____
(Please specify the license number and date of expiry)
- b) The structural report, details and drawings are prepared and supplied by Registered Structural Engineer: _____ (if Applicable)
(Please Specify the license number and date of expiry)
- c) The site supervision of the construction work will be done by Registered Clerk of Work: _____ (if Applicable)
(Please Specify the license number and date of expiry)

I shall be responsible for ensuring that the development complies with the Development Rules framed by the Competent Authority under the provisions of the Act. I shall fulfil my duties and responsibilities in accordance with the provisions of the Development Rules.

Signature of Owner / Developer or Authorized Agent of Owner _____

Date: _____

Table No. F10C – 1: Information Sheet with Application for Development Permission for Temporary Construction

No.	Title	Details			
1	Ownership Details				
	1.1	Applicant's Name			
	1.2	Postal Address for correspondence			
	1.3	Address of Land in Question			
	1.4	Applicants interest / title in land with respect of record of rights			
2	Land Details - Legal				
	2.1	Land Description			
	2.2	Village Name			
	2.3	TPS/Revenue village / Gamtal			
	2.4	FP No/ Revenue Survey No./ C S No			
	2.5	Sub-Plot No/Tenement No			
	2.6	Ward			
	2.7	Zone			
	2.8	Details of Approval before taken			
3	Was land in question used for temporary construction in the past?				
	3.1	Yes/ No	If YES, please specify details		
4	Land Occupancy Type Existing		Tick as applicable	Land Occupancy Type- Proposed	Tick as applicable
	4.1	Vacant		Vacant	
	4.2	Partly - Built		Partly - Built	
	4.3	Fully - Built		Fully - Built	
5	Site Details				
	A Width of Road Abutting the Site		TP Road	Non-TP Road/DP Road/Other Road	BRTS Corridor
	5.1	Road 1: Front Side			
	5.2	Road 2: Other than Front Side			
	5.3	Road 3: Other than Front Side			
	5.4	Road 4: Other than Front Side			
	B Seismic Details		Yes/ No	Zone No.	Details
	5.5	Seismic Zone			
	C Water Supply		Available by Local Government/ Authority	Bore Well	
	5.6	Water Supply Facility in Building-unit			
	D Drainage		Available by Local Government/ Authority	Not Available	
	5.7	Drainage Facility in Building- unit			
	E Storm Water		City Network	Percolation Pit/ Percolating Well/ Recharge Pit	
	5.8	Storm Water Facility in Building-unit			
	F Solid Waste Disposal		Local Government/ Authority	None	
5.9	Solid Waste Disposal Facility in Building-unit				
G Electricity		Available by Torrent/GEB /Other	None		
5.10	Electricity facility in Building- unit				
6	Land-Use Details				
	A Existing Use		Details		

No.	Title	Details			
		Use Sub-type	Total Units	Max. Height.	Total Area
6.1	Residential				
6.2	Commercial				
6.3	Mixed Use				
6.4	Industrial				
6.5	Others (please specify)				
B Proposed Use		Details			
6.6	Residential				
6.7	Commercial				
6.8	Mixed Use				
6.9	Industrial				
6.10	Others (please specify)				
Attachments: Annexure as above					

Form No. 11A

Area Statement for Buildings

(See Schedule No. 6A)

Table No. F11A – 1: Area Statement for Buildings

No	Title	Details (Area in sq m)		Supporting Documents Provided Yes / No / Not required
A	Building-unit Area			
	A.1 (a) As per Revenue Record			
	A.2 (b) As per TPS Record			
	A.3 (c) Per site condition			
B	Deduction Area			
	B.1 (a) Roads (Proposed or under process)			
	B.2 (b) Reservations (under TP or DP or any other Statutory Plans / Under provision of GDR)			
	B.3 Area- not in possession			
	B.4 Other			
C	Net Area			
Existing				
No	Title	Details (Area in sq m/ Nos./ m)		Supporting Documents Provided Yes / No / Not required
		Required	Provided	
1	Common Plot			
2	Width of Roadside Margin			
	2.1 Width of Other than Roadside Margin			
	2.2 Total Marginal Area			
3	Width of Internal Road			
	3.1 Internal Road Area			
4	Total Permissible Ground-coverage			
5	Permissible FSI - Base (as per old DP)			
6	Permissible FSI - Chargeable			
7	FSI Consumed			
8	Ground Coverage			
9	Use	Use Sub- type	Total Built- up Area (in sq m)	No. of Units Drawings Provided Yes / No
	Existing Use - as per old DP			
	9.1 Residential			
	9.2 Commercial			
	9.3 Mixed Use			
	9.4 Industrial			
	9.5 Others (please specify)			
	9.6 Total			
10	Floors	Numbers of Units	Floor Area/ Built-up Area/FSI (in sq m)	Payment FSI (in sq m)
Provide Details for Individual Building				
	10.1 Hollow Plinth			
	10.2 Ground Floor			
	10.3 Typical Floor			
	10.4 Floors other than Typical Floor			
	10.5 Total			

No	Title	Details (Area in sq m)		Supporting Documents Provided Yes / No / Not required
	10.6	Total of all buildings		
	10.7	Building	Building Height in mt Number of Floors	
11	Dwelling Units		Numbers of Units	Total Unit Area (in sq m) Details of unit area (Size) of Individual Unit (in sq m)
	Provide Details for individual Building			
	11.1	1BHK		
	11.2	2BHK		
	11.3	3BHK		
	11.4	4BHK		
	11.6	More than 4BHK		
	11.7	Others (e.g., Studio units, penthouse etc.)		
	11.8	Other than Dwelling Units		
	11.9	Total		
12	Basement		Number of Basement	Area per Basement (in sq m) Total Basement Area
	12.1	Basement 1: Area		
	12.2	Basement 2: Area		
	12.3	Others		
	Existing Area Statement for Parking			
13	Parking		Area (in sq m)	Percentage (%)
	13.1	Area under parking (including visitors parking)		% of Total Built-up Area
	13.2	Visitors Parking		% of Total Parking Area
	13.3	Covered Parking		% of Total Parking Area
	13.4	Open Parking		% of Total Parking Area
	13.5	Sports & Leisure		
	13.6	Parks		
	13.7	Service establishment		
	13.8	Industrial		
	13.9	Storage		
	13.10	Transport		
	13.11	Agriculture		
	13.12	Temporary Use		
	13.13	Public Utility		
	13.14	Public Institutional		
14	Floors/Levels		Numbers of Units	Floor Built-up Area/FSI Payment FSI (in sq m)
	Provide Details for individual Building			
	14.1	Basement		
	14.2	Hollow Plinth		
	14.3	Ground Floor		
	14.4	Typical Floor		
	14.5	Floors other than Typical Floor		
	14.6	Total		
14.7	Total of all buildings			
15	Dwelling Units		Numbers of Units	Total Unit Area (in sqm) Details of unit area (Size) of Individual Unit (in sqm)
	Provide Details for individual Building			

No	Title		Details (Area in sq m)		Supporting Documents Provided Yes / No / Not required	
	15.1	1BHK				
	15.2	2BHK				
	15.3	3BHK				
	15.4	4 BHK				
	15.5	More Than 4BHK				
	15.6	Others (e.g., Studio units, penthouse etc.)				
	15.7	Other than Dwelling Units				
	15.8	Total				
	15.9	Total of all buildings				
16	Dwelling Units		Carpet Area of each Unit (in sq m)	Details of Balcony & Verandah area (Size) of Individual Unit (in sq m)	Proportionate Common Amenities area in sq m	Total Built up Area (sq m)
	16.1	Ground Floor				
	16.2	First Floor				
17	Building		Building Height in meters		Number of Floors	
18	Floor Level		Each Dwelling Unit (DU) No.	Carpet Area of Each DU (in sq m)	Total Carpet Area of Each Type (In sq m)	Total Carpet Area on Each Floor (in sq m)
	Ground Floor					
	First Floor					
Proposed Area Statement for Parking						
19	Parking		Area (in sq m)		Percentage (%)	
	19.1	Parking Area required as per Regulation (please specify in % as well as area)			%Of Total Built-up Area	
	19.2	Proposed Parking Area (please specify in % as well as area)			% Of Total Built-up Area	
	19.3	Visitors parking area required at Ground Level (please specify in % as well as area)			% Of Total Built-up Area	
	19.4	Visitors parking area provided at Ground Level (please specify in % as well as area)			% Of Total Built-up Area	
20	Parking		Area (in sq m)	No. of Parking spaces for 2-wheelers	No. of Parking spaces for 4-wheelers	
	20.1	Proposed Parking on Ground Level (including Hollow Plinth)				
	20.2	Proposed Parking on Basement Level				
	20.3	Proposed Parking on levels above Hollow Plinth				
	20.4	Covered Parking				
	20.5	Open Parking				
	20.6	Total				
Build-to-line						
*Building-Unit (Plot) as mentioned in Local Area Plan, please provide the following details.						
1	Length of Build-to-Line				In meters	
2	Length of Build-to-Line coinciding the front façade of the building				In meters	
3	Percentage of length of Build-to- line coinciding the front façade of the building				%	
Proposal Details						

No	Title	Details (Area in sq m)			Supporting Documents Provided Yes / No / Not required
Description of proposed property					
List of Drawings	No. of Copies	North	Scale of drawing	Remarks	
Plans					
Layout Plan					
Site plan					
Detailed Plan					
Sections					
Elevations					
Services & Amenities Plan					
Landscape Plan					
Ref Description of last approved plans (If any)			Date		

Form No. 11B**Area Statement for Subdivision / Amalgamation /Layout of Land**

(See Schedule No. 6B)

Table No. F11B – 1: Area Statement for Subdivision / Amalgamation / Layout of Land

No.	Area Statement Particular		Sq m		
1	Area of Plot/Plots			1. List of Drawing attached	
	1.1	Internal Road Area			
	1.2	Common plot/ Plots			
	1.3	Amalgamated Area (in case of amalgamation)			
2	Deduction for:			2. Ref. & Description of Last approved plans if any	
	2.1	Proposed roads		Date	
	2.2	Any reservation			
	2.3	Not in Possession			
	2.4	Other			
Total: (a+b+c+d)					
3	Net area of plot (1-2)				
4	(In case of Sub-Division) Common plot / Plots Internal Roads			3. Description of proposed development and property	
5	Balance area of Sub plot/sub plots (3-4)				
	Permissible F.S.I.				
Total Built-up area permissible			4.		
6	Existing floor area			North line	Scale
	F.S.I.				Remarks
	Notes:				
				5. Certificate	
				Certified that the plot under reference was surveyed by me on and the dimensions of sides etc. of plot state on plan are as measure on site and the area so worked out tallies with the area stated in document of ownership / T.P. record. Architect/Engineer Signature.	
				6. Signatories	
				Signatory, Name, and address with	
				Regn. No.	
				Owner/ Developer/	
				Architect/	
				Engineer/Clerk of works/Site supervisor	

	A	Area Statement	Sq m			
For Subdivision/ Amalgamation/ Layout of Land	1	Area of Plot/Plots		I. List of Drawing attached		
		Internal Road Area		No. of copies		
		Common plot/ Plots				
		Amalgamated Area (in case of amalgamation)				
	2	Deduction for:			II. Ref. & Description of Last approved plans if any	
		(a)	Proposed roads		Date	
		(b)	Any reservation			
		(c)	Not in Possession			

	A	Area Statement	Sq m			
		(d) Other				
		Total: (a+b+c+d)				
	3	Net area of plot (1-2)				
SITE PLAN (Under regulation no. 4.10.1/4.11.1/4.16.1) Layout Plan (under regulation no. 4.12, 4.13, 4.14, 4.15)	4	(In case of Sub-Division) Common plot/ Plots Internal Roads		III. Description of proposed development and property		
	5	Balance area of Sub plot/sub plots (3-4)				
		Permissible F.S.I.		IV.		
		Total Built-up area permissible				
		Existing floor area		North line	Scale	Remarks
	F.S.I.					
	Notes:					
				V. Certificate		
				Certified that the plot under reference was surveyed by me on and the dimensions of sides etc. of plot state on plan are as measure on site and the area so worked out tallies with the area stated in document of ownership / T.P. record. Architect/Engineer Signature.		
				VI. Signatories		
				Signatory, Name, and address with		
				Regn. No.		
				Owner/ Developer/		
				Architect/		
				Engineer/Clerk of works/Site supervisor		

Form No. 11C

Area Statement for Temporary Construction

(See Schedule No. 6D)

Table No. F11C – 1: Area Statement for Temporary Construction

No.	Area Statement Particular	Sq m				
1	Area of Plot/Plots		1. List of Drawing attached		No. of copies	
	1.1 Internal Road Area					
	1.2 Common plot/ Plots					
	1.3 Amalgamated Area (in case of amalgamation)					
2	Deduction for:		2. Ref. & Description of Last approved plans if any		Date	
	2.1 Proposed roads					
	2.2 Any reservation					
	2.3 Not in Possession					
	2.4 Other					
Total: (a+b+c+d)						
3	Net area of plot (1-2)					
4	(In case of Sub-Division) Common plot / Plots Internal Roads		3. Description of proposed development and property			
5	Balance area of Sub plot/sub plots (3-4)		4.			
	Permissible F.S.I.					
	Total Built-up area permissible					
6	Existing floor area		North line	Scale	Remarks	
	F.S.I.					
	Notes:					
				5. Certificate		
				Certified that the plot under reference was surveyed by me on and the dimensions of sides etc. of plot state on plan are as measure on site and the area so worked out tallies with the area stated in document of ownership / T.P. record. Architect/Engineer Signature.		
				6. Signatories		
				Signatory, Name, and address with		
				Regn. No.		
				Owner/ Developer/		
				Architect/		
				Engineer/Clerk of works/Site supervisor		

Form No.12

Grant / Refusal of Development Permission / Revised Development Permission / Revalidated Development Permission

(Refer Rule No. 4.11.3, 4.15.3)

Permission is hereby granted/refused under Section 44(3a) (i)/ 44(3a) (ii) / 44(3a) (iii)/ 44(3b) (1)/ 44 (3b) (ii), 49, 66 of The Dadra and Nagar Haveli and Daman & Diu Town & Country Planning Act, 1974, as the case may be.

To

(Name of person)

Proposed Development:

(Title of the work)

Plot No /Sub Plot No.: _____ Area of the Plot / Sub Plot: _____ (sq m)

Survey No.: _____ Area of Survey No.: _____ (sq m)

Final Plot No.: _____ Area of Final Plot No.: _____ (sq m)

Full Address of Proposed Development:

Name of the Owner / Developer: _____

Sir

With reference your application dated _____, for Development Permission for:

- Development on building unit
- Development of layout
- Subdivision of building unit
- Amalgamation of building unit

Has been

A **Granted on following conditions before commencement of work (if any):**

1 _____
2 _____

Development may be undertaken as per sanctioned design and specifications. This Development Permission is to be read in conjunction with all other document and drawings which enclosed as per the provision of Rule 4 and Schedule 6A, 6B, 6C & 6D, and that all such documents, drawings and specifications form a part of this Development Permission.

B Refused on the following grounds:

1 Documents /NOC etc.:

Following documents /plans /NOC / undertakings as mentioned in Form No. 1 are not submitted.

2 Site Clearance:

i) Site is not cleared as per the provisions of the Outline Development Plan with respect to

- Road line
- Reservations
- Zone
- Other (specify)

ii) Site is not cleared as per the provision of TP Scheme _____ with respect to

- Road
- Reservation
- Final plot
- Other (specify)

iii) Proposed use is not permissible according to the width of road as per the Provision No.7.7.

3 Scrutiny of Layout:

Following provisions are not as per the Development Rules:

- Set back
- Margin
- Common plot
- Internal roads
- Parking space
- Ground coverage
- Any other (specify)

4 Scrutiny of Building Requirements:

Following provisions are not as per the Development Rules

- FSI.
- Height
- Ventilation
- Open air space
- Provisions for Fire protection
- Any other (specify)

Yours faithfully

The Competent Authority

Form No. 13

Application for Revised Direct Development Permission

(See Reg. No. 4.12.1)

To,

The Competent Authority

Proposed Development:

(Title of the work)

Plot No /Sub Plot No.: _____ Area of the Plot / Sub Plot: _____ (sq m)

Survey No.: _____ Area of Survey No.: _____ (sq m)

Final Plot No.: _____ Area of Final Plot No.: _____ (sq m)

Full Address of Proposed Development:

Name of the Owner / Developer: _____

Sir,

I am currently registered as Architect on Record with Competent Authority and am fully conversant with the General Development Rules. I have been appointed as the Architect on Record of the proposed development. I hereby certify that I have verified the revisions made to the designs and specifications of the proposed development and certify that they comply with the General Development Rules.

I hereby issue a Revised Direct Development Permission for construction of the proposed Development. This Revised Direct Development Permission is to be read in conjunction with all other documents and drawings which are enclosed as per the provisions of Rule No 4.14.1 and its Schedules, and that all such documents, drawings and specifications form part this Revised Direct Development Permission.

I fully understand that in case my certificate is found to be false, or if it is found that the Revised Direct Development Permission issued by me is inconsistent with the General Development Rules or that I have not fulfilled my responsibilities as prescribed therein, the PDA / CA shall be at liberty to penalize me / revoke my registration as per the provisions of the Act and Rules.

Name of the AOR: _____

Registration No.: _____

Address: _____

Tele. No.: _____

Signature: _____

Date: _____

Form No. 14

Application for Registering Issue of Revised Direct Development Permission

(See Rule No. 4.12.1)

To,

The Competent Authority

Proposed Development:

(Title of the work)

Plot No /Sub Plot No.: _____ Area of the Plot / Sub Plot: _____ (sq m)

Survey No.: _____ Area of Survey No.: _____ (sq m)

Final Plot No.: _____ Area of Final Plot No.: _____ (sq m)

Full Address of Proposed Development:

Name of the Owner / Developer: _____

Sir,

I am currently listed as Architect on Record with Competent Authority. I am fully conversant with the General Development Rules.

I have been appointed as the Architect on Record of the proposed development. I hereby certify that I have verified the revisions to the design and specifications of the proposed development and certify that they comply with the General Development Rules of the PDA.

I have issued a Revised Direct Development Permission for construction of the proposed Development and hereby apply for registration of the same on the records of the PDA.

I fully understand that in case my certificate is found to be false, or if it is found that the Direct Development Permission issued by me is inconsistent with the General Development Rules of the PDA shall be at liberty to penalize me.

Name of the AOR: _____

Registration No.: _____

Address: _____

Tele. No.: _____

Signature: _____

Date: _____

Form No. 15

Application for Revising Development Permission for Building / Layout / Sub-division / Amalgamation

(Refer Rule No. 4.13.1, 4.13.3)

To,

The Competent Authority

Proposed Development:

(Title of the work)

Plot No /Sub Plot No.: _____ Area of the Plot / Sub Plot: _____ (sq m)

Survey No.: _____ Area of Survey No.: _____ (sq m)

Final Plot No.: _____ Area of Final Plot No.: _____ (sq m)

Full Address of Proposed Development:

Name of the Owner / Developer: _____

Sir/ Madam,

I am the Owner / Developer of the building unit / plot and wish to undertake:

- Development on building unit
- Development of layout
- Subdivision of building unit
- Amalgamation of building unit

The Development Permission No. _____ has been granted to me by the Competent Authority vide Letter No. _____ dated _____. I wish to vary the sanctioned layout / design & specifications of the proposed building. I shall be responsible for ensuring that the building complies with the General Development Rules.

I request that the Revised Development Permission be granted to me.

Name of the Owner/Developer: _____

Address: _____

Tel. No.: _____

Signature: _____

Date: _____

Form No. 16

Application for Revalidating Direct Development Permission / Revised Direct Development Permission

(Refer Rule No. 4.14.1)

To,

The Competent Authority

File No: _____

Dated: _____

Proposed Development:

(Title of the work)

Plot No /Sub Plot No.: _____ Area of the Plot / Sub Plot: _____ (sq m)

Survey No.: _____ Area of Survey No.: _____ (sq m)

Final Plot No.: _____ Area of Final Plot No.: _____ (sq m)

Full Address of Proposed Development:

Name of the Owner / Developer: _____

Sir,

I am currently listed as Architect on Record with the PDA and am fully conversant with the General Development Rules of PDA. I have been appointed as the Architect on Record of the proposed Development. The Direct Development Permission that was issued on _____ (date) by _____ (name of the Architect on Record) has lapsed /suspended due to _____.

I hereby certify that I have verified the design and specifications of the proposed Development and certify that they comply with the General Development Rules. I hereby issue a Revalidated Direct Development Permission for construction of the proposed development. This Revalidated Direct Development Permission is to be read in conjunction with all other documents and drawings which are enclosed as per the provisions of Rule No 4.14.1 and its Schedules, and that all such documents, drawings, and specifications form part of this Revalidated Direct Development Permission.

I fully understand that in case my certificate is found to be false, or if it is found that the Revalidated Direct Development Permission issued by me is inconsistent with the General Development Rules the PDA shall be at liberty to penalize me as per the provisions of the Act and Rules.

Name of the AOR: _____

Registration No.: _____

Address: _____

Tele. No.: _____

Signature: _____

Date: _____

Form No. 17

Application for Registering Revalidating Direct Development Permission / Revised Direct Development Permission

(Refer Rule No. 4.14.1)

To,

The Competent Authority

Proposed Development:

(Title of the work)

Plot No /Sub Plot No.: _____ Area of the Plot / Sub Plot: _____ (sq m)

Survey No.: _____ Area of Survey No.: _____ (sq m)

Final Plot No.: _____ Area of Final Plot No.: _____ (sq m)

Full Address of Proposed Development:

Name of the Owner / Developer: _____

Sir,

I am currently listed as Architect on Record with Competent Authority. I am fully conversant with the General Development Rules.

I have been appointed as the Architect on Record of the proposed development. This is to notify you that the Direct Development Permission issued on _____ (date) by _____ (name of the Architect on Record) had lapsed on _____ (date) due to _____.

I hereby certify that I have verified the design and specifications of the proposed Development and certify that they comply with the General Development Rules of the PDA.

I have issued a Revalidated Direct Development Permission for construction of the proposed Development and hereby apply for registering the same on the records of the Corporation. I fully understand that in case my certificate is found to be false, or if it is found that the Revalidated Direct Development Permission issued by me is inconsistent with the General Development Rules of PDA, the PDA shall be at liberty to penalize me as per the provisions of the Act and Rules.

Name of the AOR: _____

Registration No.: _____

Address: _____

Tele. No.: _____

Signature: _____

Date: _____

Form No. 18
Application for Revalidating a Lapsed / Suspended Development Permission / Revised Development Permission

(Refer Rule No. 4.15.1)

To,

The Competent Authority

Proposed Development:

(Title of the work)

Plot No / Sub Plot No.: _____ Area of the Plot / Sub Plot: _____ (sq m)

Survey No.: _____ Area of Survey No.: _____ (sq m)

Final Plot No.: _____ Area of Final Plot No.: _____ (sq m)

Full Address of Proposed Development:

Name of the Owner / Developer: _____

Sir/ Madam,

I am the Owner/Developer of the plot and wish to undertake construction of the proposed building on the building-unit.

The Development Permission has been granted to me by the Competent Authority vide Letter No. _____ dated. The Development Permission that was issued on (date) by the Competent Authority shall lapse on / has lapsed / suspended on _____(date) due to _____

I shall be responsible for ensuring that the building complies with the General Development Control Rules. I request that the Revalidated Development Permission be granted to me.

Name of the Owner/Developer: _____

Address: _____

Tel. No.: _____

Signature: _____

Date: _____

Form No. 19
Notice for Commencement of Construction

(Refer Rule No. 5.5.1)

To,

The Competent Authority

File No: _____

Dated: _____

Proposed Development:

(Title of the work)

Plot No /Sub Plot No.: _____ Area of the Plot / Sub Plot: _____ (sq m)

Survey No.: _____ Area of Survey No.: _____ (sq m)

Final Plot No.: _____ Area of Final Plot No.: _____ (sq m)

Full Address of Proposed Development:

Name of the Owner / Developer: _____

Sir/ Madam,

This is to notify you that the construction of the proposed building / development shall commence on _____ (date). The construction of the building / development shall be undertaken in compliance with the sanctioned design & specifications and the General Development Rules.

Enclosed with this Notice are:

Detailed Working Drawings including structural design and specifications duly verified and certified by the Architect on Record / Civil Engineer on Record and Structural Engineer on Record for the project.

Name of AOR/EOR

Registration No.:

Address:

Tel. No.:

Signature:

Date:

Name of Clerk of Works:

Registration No.:

Address:

Tel. No.:

Signature:

Date:

Signature of Owner with date: _____

Name: _____

Address: _____

Form No. 20
Notice for Progress of Construction

(Refer Rule No. 5.5.3, 6.6.3)

To

The Competent Authority

File No: _____

Dated: _____

Proposed Development:

(Title of the work)

Plot No /Sub Plot No.: _____ Area of the Plot / Sub Plot: _____ (sq m)

Survey No.: _____ Area of Survey No.: _____ (sq m)

Final Plot No.: _____ Area of Final Plot No.: _____ (sq m)

Full Address of Proposed Development:

Name of the Owner / Developer: _____

Sir/ Madam,

This is to notify you that the construction of the proposed building has reached the following stage:

No	Stage	Date
1	Plinth level	
2	Ground Floor	
3	Middle storey	
4	Last storey	

The construction of the building / development is in compliance with the sanctioned drawings and the General Development Rules. We declare that the amended plan is not necessary at this stage.

Name of AOR/EOR

Registration No.:

Address:

Tel. No.:

Signature:

Date:

Name of Clerk of Works:

Registration No.:

Address:

Tel. No.:

Signature:

Date:

Signature of Owner with date: _____

Name: _____

Address: _____

Form No. 21
Notice for Completion and Compliance Certification

(Refer Rule No. 6.5.1, 6.6.3)

To,

The Competent Authority

File No: _____

Dated: _____

Proposed Development:

(Title of the work)

Plot No /Sub Plot No.: _____ Area of the Plot / Sub Plot: _____ (sq m)

Survey No.: _____ Area of Survey No.: _____ (sq m)

Final Plot No.: _____ Area of Final Plot No.: _____ (sq m)

Full Address of Proposed Development:

Name of the Owner / Developer: _____

Sir/ Madam,

This is to notify you that the construction of the proposed building / development has been completed under our supervision.

We hereby certify that the construction of the building has been undertaken in compliance with the sanctioned drawings and the General Development Rules. We declare that the building is to be used for purpose as per approved plan and it shall not be changed without obtaining written permission.

Any subsequent change from the completion drawings will be our responsibility.

Name of AOR/EOR

Registration No.:

Address:

Tel. No.:

Signature:

Date:

Name of SEOR

Registration No.:

Address:

Tel. No.:

Date:

Signature of Owner with date: _____

Name: _____

Address: _____

Form No. 22A
Application for Occupancy Certificate

(Refer Rule No. 6.5.1, 6.6.3)

To

The Competent Authority

File No: _____

Dated: _____

Proposed Development:

(Title of the work)

Plot No /Sub Plot No.: _____ Area of the Plot / Sub Plot: _____ (sq m)

Survey No.: _____ Area of Survey No.: _____ (sq m)

Final Plot No.: _____ Area of Final Plot No.: _____ (sq m)

Full Address of Proposed Development:

Name of the Owner / Developer: _____

Sir / Madam,

This is to notify you that the proposed building(s)/ fully built (No. of building blocks) out of the proposed building blocks has been completed in compliance with the sanctioned drawings and the General Development Rules.

Enclosed with this application are:

- 1 Notice of Completion of Construction and Compliance Certification as prescribed in Form No. 21.
- 2 One set of Completion Plans and as-built drawings, duly certified by the POR.
- 3 Form No. 2: Certificates of Undertaking by the Architect on Record or Engineer on
- 4 Record; and form No. 2: Certificates of undertaking by the QAORF
- 5 Form No. 2: Certificates of Undertaking by the Structural Engineer on Record,
- 6 Form No. 2: Certificates of Undertaking by the Clerk of Works on Record,
- 7 Clearance from Fire Officer, as applicable & mentioned in Schedule No. 4
- 8 A copy of valid Registration Certificate of the Persons on Record issued by the Competent Authority.
- 9 Certificate of lift Inspector (Government of UT) for buildings taller than 15 m / 17.5 (with Stilt).

We request that the Occupancy Certificate be granted to the building. Any subsequent change from the completion drawings will be our responsibility.

Name of the Owner/Developer: _____

Address: _____

Tel. No.: _____

Signature: _____

Date: _____

Form No. 22B

Application for Occupancy Certificate of Temporary Construction

(Refer Rule No. 6.5.1, 6.6.3)

To

The Competent Authority

File No: _____

Dated: _____

Proposed Development for Temporary Construction:

(Title of the work)

Plot No /Sub Plot No.: _____ Area of the Plot / Sub Plot: _____ (sq m)

Survey No.: _____ Area of Survey No.: _____ (sq m)

Final Plot No.: _____ Area of Final Plot No.: _____ (sq m)

Full Address of Proposed Development for Temporary Construction:

Name of the Owner / Developer: _____

Sir / Madam,

This is to notify you that the proposed temporary construction has been completed in compliance with the sanctioned drawings and the General Development Rules.

Enclosed with this application are:

- 1 Notice of Completion of Construction and Compliance Certification as prescribed in Form No. 21.
- 2 One set of Completion Plans and as-built drawings, duly certified by the POR.
- 3 Form No. 2: Certificates of Undertaking by the Architect on Record or Engineer on
- 4 Record; and form No. 2: Certificates of undertaking by the QAORF
- 5 Form No. 2: Certificates of Undertaking by the Structural Engineer on Record,
- 6 Form No. 2: Certificates of Undertaking by the Clerk of Works on Record,
- 7 Clearance from Fire Officer, as applicable & mentioned in Schedule No. 4
- 8 A copy of valid Registration Certificate of the Persons on Record issued by the Competent Authority.
- 9 Certificate of lift Inspector (Government of UT) for buildings taller than 15 m / 17.5 (with Stilt).

We request that the Occupancy Certificate be granted to the building. Any subsequent change from the completion drawings will be our responsibility.

Name of the Owner/Developer: _____

Address: _____

Tel. No.: _____

Signature: _____

Date: _____

Form No. 23
Grant / Refusal of Occupancy Certificate

(Refer Rule No. 6.5.3)

To

(Name of person)

Proposed Development:

(Title of the work)

Plot No /Sub Plot No.: _____ Area of the Plot / Sub Plot: _____ (sq m)

Survey No.: _____ Area of Survey No.: _____ (sq m)

Final Plot No.: _____ Area of Final Plot No.: _____ (sq m)

Full Address of Proposed Development:

Name of the Owner / Developer: _____

With reference to your Application No: _____ dated: _____ I am directed to inform you that the building unit has been inspected on date: _____ and the development is as per sanctioned design and specifications; and that Occupancy Certificate has been granted. The building / part of building may be used as per sanctioned drawings. This Occupancy Certificate is to be read in conjunction with all other documents and drawings which are enclosed as per the provisions of Rule No 7 and its Schedules, and that all such documents, drawings, and specifications form part of this Occupancy Certificate

OR

With reference to your Application No: _____ dated: _____ I am directed to inform you that the building-unit has been inspected on date _____ and that a Occupancy Certificate has not been granted on the following grounds:

- 1.
- 2.

Yours faithfully

For,
The Competent Authority

Form No. 24
Cancellation of Occupancy Certificate

(Refer Rule No. 6.3)

To

File No: _____

Dated: _____

Proposed development:

(Title of the work)

Plot No.: Area of the Plot:

Address and location of proposed development:

Sir,

This is to notify you that the Occupancy Certificate No. _____ issued or granted on date: _____ by _____ (name of the Architect on Record)/ MS PDA/ Chief Executive Authority has been revoked by the MS PDA / Chief Executive Authority on the following grounds:

- 1.
- 2.

Please note that no further use may be made of the development. A new Occupancy Certificate has to be obtained before making use of the development.

For,

The Competent Authority

Form No. 25

Change in the Sanctioned Occupancy of Building / Development

(Refer Rule No. 6.6.1, 6.6.3)

To

The Competent Authority

Proposed Development:

(Title of the work)

Plot No /Sub Plot No.: _____ Area of the Plot / Sub Plot: _____ (sq m)

Survey No.: _____ Area of Survey No.: _____ (sq m)

Final Plot No.: _____ Area of Final Plot No.: _____ (sq m)

Full Address of Proposed Development:

Name of the Owner / Developer: _____

Sir,

I am the Owner of the development to which the Occupancy Certificate has been granted by the MS PDA / Chief Officer vide Letter No. ____ dated _____. I wish to change the Sanctioned Use of the Development to a new use as specified below:

(Description of the new use to which the Development is proposed to be put to)

I shall be responsible for ensuring that the new use of the Development complies with the General Development Control Rules.

We hereby certify that in case the new use results in the Development being re-classified to a Higher Importance Factor (as defined in the IS: 1893-2002 "Criteria for Earthquake Resistant Design Structures - Fifth Revision)", the Development shall conform to seismic requirements for the Development with the Higher Importance Factor.

I request that the Permission to Change Sanctioned Use of the Development be granted.

Name of the Owner: _____

Address: _____

Tele. No.: _____

Signature: _____

Date: _____

Name of the SEOR: _____

Registration No.: _____

Address: _____

Tele. No.: _____

Signature: _____

Date: _____

Form No. 26

Structural Inspection Report

(Maintenance of Building –Schedule No. 10)

(This form has to be completed by registered Structural Engineer on Record after his / her site inspection and verification regarding compliance of all recommendation by the owner, which in the opinion of the registered Structural Engineer on Record is necessary for safety of the structure)

Table No. F26 – 1: Details of Structural Inspection Report (Part 1)

No	Description	Information	Notes
1	Title, Location and Address of the building including T.P. No, F.P. No, etc		
2	Name of Present Owner		
3	Name of Structural Engineer on Record		
4	Use of the building		
5	Year of construction		
	Year of subsequent additions		
	Nature of additions or alterations		
6	Date of Last Inspection Report		
	SEOR for Last Inspection Report		
7	Class1 -Building		
8	Class2 -Building		
9	Type of structure		
	i) Load bearing walls		
	ii) R.C.C frame		
	iii) R.C.C frame and Shear walls		
	iv) Steel Frame		
10	Soil data		
	i) Type of soil		
	ii) Design safe bearing capacity		
	iii) Any change subsequent to construction		
	iv) Any open excavation pit		
	v) Any water body nearby		
	vi) Proximity of drain		
	vii) Underground water tank		
	viii) Outlets of rainwater pipes		
ix) Settlements			

IS:1893Cl.6.3. 5.2
IS:1904

Table No. F26 – 2: Details of Structural Inspection Report (Part 2)

(a)Function	(b)Framed construction							
	Residence (with or without shops)	Apartments (with or Without shops)	Office Bldg.	Shopping center	School, College	Hostel	Auditoria	Factory
	1	2	3	4	5	6	7	8
A. Load bearing masonry wall construction								
Framed structure								
Construction and structural materials	Critical load bearing element	Brick	RCC	Stone	Timber	Steel		
	Roof Floor	RCC	Timber	RBC	Steel	Jack- arch		

Table No. F26 – 3: Details of Structural Inspection Report (Part 3)

Part 1 Load bearing masonry buildings		
Description	Information	Notes
1	Building category	
2	Any cracks in masonry walls	
	Extent of cracks	
	Location of cracks	
	Sketch of cracks, if necessary	
3	Recommendations, if any	
Part 2 Reinforced Concrete framed buildings		
Description	Information	Notes
1	Type of Building	
2	Any cracks in beams	
	Extent of cracks Probable causes	
3	Any cracks in columns	
	Extent of cracks Probable causes	
4	Any cracks in slab	
	Extent of cracks	
	Probable causes	
	Spilling of concrete or plaster of slab Corrosion of Reinforcement	
5	Cover Spell	
Part 3 Reinforced Concrete framed buildings		
Description	Information	Notes
6	Exposure of reinforcement	
7	Subsequent damage by user for taking pipes, conduits,	

	hanging fans or any other fixtures, etc.		
8	Loads in excess of design loads		
9	Recommendations, if any		
Part 4 Buildings in Structural Steel			
	Description	Information	Notes
1	Building category		
2	Painting		
3	Corrosion		
4	Joints, nuts, bolts, rivets, welds, gusset plates		
5	Bending or buckling of members		
6	Base plate connections with columns of pedestal		
7	Loads in excess of design loads		
8	Recommendations, if any		

This is to certify that the above is a correct representation of facts as given to me by the owner and as determined by me after Site Inspection to the best of my ability and judgment.

The recommendations made by me to ensure adequate safety of the structure are compiled with by the owner to my entire satisfaction.

Name of the SEOR: _____

Registration No.: _____

Address: _____

Tel. No.: _____

Signature: _____

Date: _____

Form No. 27
Fire Safety Certificate

(Refer Rules, Schedule No. 10)

To

The Competent Authority

Existing Building:

Survey No.:

City Survey No.:

Block No.:

Final Plot No.:

Sub Plot / Property No.:

Address and location of existing building:

Name of Owner:

Type of Structure:

Sir / Madam,

I am currently registered as Qualified Agency on Record for Fire for the above building.

This is to notify that I have inspected the above building on date _____
and to the best of my knowledge; I certify that the fire safety of the building has not been
compromised due to lack of maintenance.

Name of the QAORF: _____

Registration No.: _____

Address: _____

Tel. No.: _____

Signature: _____

Date: _____

